

NOTE: This PDF document includes interactive bookmarks, page numbers and tabs for easy navigation.
CLICK HERE for more information on navigating within this PDF document.

**DOCUMENT INCLUDES PRICE INCREASE
EFFECTIVE JULY 1, 2010**

MAGNA DESIGN

by WATSON

2010 Series Fifty Product Price List



GENERAL SERVICES ADMINISTRATION

Federal Acquisition Service

Authorized Federal Supply Schedule Price List

On-line access to contract ordering information, terms and conditions, up-to-date pricing, and the option to create an electronic delivery order are available through GSA Advantage!, a menu-driven database system. The INTERNET address GSA Advantage! is GSAAvantage.gov.

FSC Group 71, Part I, Office Furniture

FSC Class 7110

Contract Number: GS-29F-0109G

Contract Period: 10/01/06 - 09/30/11

For more information on ordering from Federal Supply Schedules click on the FSS Schedules button at fss.gsa.gov.

WATSON FURNITURE GROUP

26246 Twelve Trees Lane NW

Poulsbo, WA 98370

Phone: (360) 394-1300

Fax: (360) 394-1322

Toll Free: (800) 426-1202

Website: www.watsondesking.com

Business Size: Small

SUSTAINABLE BEAUTY. Masterfully Designed, Mindfully Made.

71, Part I, OFFICE FURNITURE

Free Standing Computer Furniture, Workstations, Conference Room and Multi-purpose Tables, Display and Communication Boards.

GENERAL SERVICES ADMINISTRATION - Federal Supply Service - Authorized Federal Supply Schedule - Price List / Catalog

Schedule Title: Office Furniture
FSC Group 71, Part I, FSC Class 7110-1045
Contract No.: GS-29F-0109G
Contract End Date: 12-31-2011

Contractor: Magna Design

26246 Twelve Trees Lane NW
Poulsbo, Washington 98370
Tel: 800.426.1202 Fax: 360.394.1322
Eml: info@magnadesign.com

Business Size: Large

On-line access to Contract ordering information, terms and conditions, up-to-date pricing, and the option to create an electronic delivery is available through *GSA Advantage!™*, a menu-driven database system.

The internet address for *GSA Advantage!™* is: <http://www.gsa.gov>

Effective July 20, 2007, this GSA contract includes our freight and fuel surcharges. For details, see page 3.

1. **Special Item Numbers (SIN)**
 - 711-2 Worksurfaces, workstations, computer furniture and related items.
 - 711-3 Filing and storage cabinets, shelves, mobile carts, dollies, racks and accessories.
 - 711-11 Tables
 - 711-12 Modular connecting tables
 - 711-94 Design and Layout
 - 711-95 Installation

2. **Maximum Order Limitation:**
 - SIN 711-2,3,11,12 \$ 500,000.00
 - SIN 711-94 \$45.00 per hour
 - SIN 711-95 16% of net up to \$3,125 net over \$3,125 net, negotiated per order

3. **Minimum Order Limitation: \$ 100.00 all SIN**

4. **Geographic coverage: All 50 states**

5. **Point of Production:**
Magna Design
26246 Twelve Trees Lane NW
Poulsbo, WA 98370

6. **Discount from List:**
for SIN 711-2, 711-3, 711-11, 711-12, 711-94, 711-95
All shipments are F.O.B. Magna Design plant, Lynnwood, WA. Prices shown are LIST and do NOT include crating, cartoning, storage or inside delivery.

Our standard shipping is 'blanket wrapped'. When using the 'Customer pays freight' discount, the 'common carrier' may require our products to be shipped in wood crates. The 'crating' charge is 8% of the product net price.

Effective July 20, 2007 our freight / fuel surcharge applies to all GSA orders. See page 3 for details.

Based on Magna Design's Price List Books below:

Conference and Meeting,
October 2007 - Purple cover or
August 2006 - Dark Green Cover plus 6%

Use the following discounts:

Customer pays freight:
Discount from List Price to Customer NET is 57.90% and then the charges below are added as needed.

Add 8% of the product total for crating if the shipment is not 'blanket-wrap'

Factory freight program:

Discount from List Price to Customer NET is 52.62% and then the charges below are added as needed.
10% freight surcharge on orders less than \$10,000 List
1% fuel surcharge on orders over List \$10,000 and less than NET \$30,000 to the 'West' region

2% fuel surcharge on orders over List \$10,000 and less than NET \$45,000 to the 'Mid-West' region
3% fuel surcharge on orders over List \$10,000 and less than NET \$60,000 to the 'East' region

Based on Magna Design's Price List Books below:

Modular 8 Components,
October 2007 - Purple cover or
August 2006 - Dark Green Cover plus 6%

~~**Equations,**
October 2007 - Purple cover or
August 2006 - Dark Green Cover plus 6%~~

Series 50,
October 2007 - Purple cover or
August 2006 - Dark Green Cover plus 6%

Use the following discounts:

Customer pays freight:
Discount from List Price to Customer NET is 59.90% and then the charges below are added as needed.

Add 8% of the product total for crating if the shipment is not 'blanket-wrap'

Factory freight program:

Discount from List Price to Customer NET is 54.88% and then the charges below are added as needed.
10% freight surcharge on orders less than \$10,000 List
1% fuel surcharge on orders over List \$10,000 and less than NET \$30,000 to the 'West' region
2% fuel surcharge on orders over List \$10,000 and less than NET \$45,000 to the 'Mid-West' region
3% fuel surcharge on orders over List \$10,000 and less than NET \$60,000 to the 'East' region

7. **Quantity Discounts (based on NET prices):**

SIN 711-2, and SIN 711-3	
\$ 15,000 - \$ 50,000	1.0 %
\$ 50,001 - \$ 100,000	2.0 %
\$ 100,001 - \$ 500,000	3.0 %
SIN 711-11, and SIN 711-12	
\$ 15,000 - \$ 50,000	1.0 %
\$ 50,001 - \$ 100,000	2.0 %
\$ 100,001 - \$ 500,000	4.5 %

8. **Prompt Payment Terms: NET 30 days**

9. **Government Credit Cards: Accepted (no additional discount)**

10. **Foreign items None**

11a. **Time of Delivery 10 - 45 days ARO**

11b. **Expedited Delivery**
MagnaNOW! Product ONLY
Equations Standard components and configurations using current WoodPlus standard finishes.
Per Equations Pricelist, August 2006, pg. 9-49.

Modular 8 WoodPlus components and configurations using WoodPlus edges and WoodPlus current finishes, per Mod 8 Components Price Catalog, August 2006.

Series 50 WoodPlus components and configurations using WoodPlus edges and WoodPlus components per Series 50 Price List, August 2006.

Glass doors not included
Reception stations and Storage Towers NOT included.
Hutches over 84" long NOT included.

WoodPlus Conference Tables using WoodPlus edges and current finishes and finish patterns, as shown on page 3 of the Conference and Meeting Price Catalog August 2006.

12 F.O.B. Point:

Poulsbo, Washington

Freight Claims: Before signing a delivery receipt, make certain that the goods are inspected for possible damage. If there is visual damage, record the extent of the damage on all copies of the Bill of Lading before signing. If there is no visual damage to goods that are cartoned or crated, we strongly suggest that the merchandise be unpacked and inspected immediately. If damages are discovered, save the packaging and contact the carrier immediately for inspection. Claims for damages should be filed with the delivering carrier and payment for the goods may not be withheld pending settlement of the carrier damage claims. Magna Design assumes no liability for freight damage.

Ordering Information

13. Ordering Address:

Magna Design
26246 Twelve Trees Lane NW
Poulsbo, WA 98370
Tel: 800.426.1202
Fax: 360.394.1322

14. Payment Address:

Magna Design
26246 Twelve Trees Lane NW
Poulsbo, WA 98370
Tel: 800.426.1202
Fax: 360.394.1322

15. WARRANTY

Magna Design warrants that its products are free from defects in design, material and workmanship under normal use with proper care and maintenance.

This warranty will remain in effect for the following period of time, commencing with the date of purchase from MAGNA DESIGN, but only so long as the original purchaser continues to own the product:

- WoodPlus² finishes on product purchased January 2002 or later LIFETIME
- Drawer Slides LIFETIME
- LIFETIME for all products and components, not shown below.
- Magnacare Healthcare furniture TEN (10) years
- Electrical components and functional mechanisms such as keyboard trays FIVE (5) years
- Wood edges THREE (3) years

During the term of this Warranty, Magna Design will repair or replace without charge any product or part that malfunctions or fails to conform to this Warranty. THIS REMEDY OF REPAIR OR REPLACEMENT IS PURCHASER'S SOLE AND EXCLUSIVE REMEDY WITH REGARD TO ANY PRODUCT DEFECT.

This Warranty does not apply to:
Any Damage caused during shipment
Any product installed or used other than in accordance with MAGNA DESIGN guidelines.
Any product that has been repaired, altered or modified by any person other than MAGNA DESIGN.
Any attachment added to a product
Any fabric or upholstery material
Any part or material provided by Purchaser, or
Any damage caused by misuse, abuse or negligence on the part of Purchaser or any third party.

THERE ARE NO OTHER WARRANTIES, EITHER EXPRESSED OR IMPLIED, INCLUDING ANY WARRANTY OF MERCHANTABILITY OR OF FITNESS FOR A PARTICULAR PURPOSE. UNDER NO CIRCUMSTANCE WILL MAGNA DESIGN BE LIABLE FOR ANY CONSEQUENTIAL OR INCIDENTAL DAMAGES ARISING FROM ANY PRODUCT DEFECT.

This warranty is in effect for products shipped on or after May 1, 1998.

16. Export Packing Charges:
Contact factory for quotation on Export packing charges

17. Credit Card Terms Yes, no additional discounts

18. Rental, Maintenance N/A

19. Installation Terms 16% of net up to \$3,125 net over \$3,125 net, negotiated per order

20. Repair Parts Terms N/A

21. List of Services and Distribution Points N/A

22. Preventive Maintenance N/A

23. Inside Delivery
The actual cost incurred for providing inside delivery services will be negotiated between Magna Design and the customer.

24. Returns, Cancellations & Change Policy

Returned Goods: No product may be returned without 20 days prior written notice and written Returned Goods Authorization (RGA) from Magna Design. Returned goods will be subject to a minimum 15% restocking charge in addition to shipping costs. (See Warranty policy for defective goods).

Cancellations: A 15% restocking charge will be applied on cancellations of standard Products. Cancellations will not be accepted on special or custom products.

Custom or Specials: Returns or cancellations on special or custom products will not be accepted.

Change orders: Order entry will take place upon receipt of a Purchase Order from an authorized Magna Design dealer. Subsequent order changes will be subject to a minimum \$25.00 processing fee. Actual change order charges may be higher depending the status of the job at the time a change is made.

25. Participating Dealers:

Please contact MAGNA DESIGN, INC.,
Customer Service at Tel: 800.426.1202 or
<http://www.magnadesign.com>
for the nearest Participating Dealer in your area.

Product included on contract

Modular 8 Components Pricelist

SIN 711-2 pages	17 - 48	51	53 except cab
	54 - 66	70 except file cab	
	71 - 102	105 - 107	109 - 130
		133 - 153	
SIN 711-3 pages	50	52 - 53 file cab	68 - 69
	70 file cab	104	108

Equations Pricelist

SIN 711-2 pages	9 - 24,	26 - 31	34 - 44
	47 - 66	68 - 72	75
	77 - 91	94	96 - 100
	25 all but EQ-166		
SIN 711-3 pages	25	EQ-166	32 peds
	33	46	67 EQ2-166
	73 peds	74	76
	92 peds	93	95
SIN 711-11 pages	32 tables	73 tables	92 tables

Series 50 Price List

SIN 711-11 page	15
SIN 711-2 pages	7 - 14, 18 - 20, 27
SIN 711-3 pages	16, 17, 21 - 28

Conference and Meeting Price List

SIN 711-11 pages	3, 28 - 68, 70 - 74, 76, 108
SIN 711-12 pages	69, 77 - 89
SIN 711-2 pages	91 - 107, 110 - 123, 125 - 126
SIN 711-3 pages	124

WoodPlus² Conference and Meeting
See Conference and Meeting Price List

THIS PAGE INTENTIONALLY LEFT BLANK

TABLE OF CONTENTS

INTRODUCTION	02
HOW TO ORDER	04
DESKS	
Shell Desks	06
Desks	07
Single Pedestal Support	12
Dual Pedestal Support	21
SECONDARY SURFACES	
Return	24
Bridge	26
Extension	27
Companion Table	30
CREDENZA	
Surfaces	32
Storage Support Cabinets	33
OVERHEAD STORAGE	
Hutches	38
Wall Mounted	43
STORAGE TOWERS	
Lateral Files	46
Storage Towers	47
Bookcases	53
ACCESSORIES	
Fabric Panels	56
Privacy Screens	58
Storage Accessories	59
Desk Accessories	60
MATERIALS & SPECIFICATIONS	63
TERMS & CONDITIONS	64
FINISHES	66

INTRODUCTION

Series Fifty: Exceptional Value

Tailored and trim, Series Fifty emanates professionalism. The freestanding components are flexible enough to transit between large- and small-scale private offices. Series Fifty's clean, crisp profile is complimented by a contemporary column leg and hutches that may be set high or low. Efficient desk shapes with fixed personal storage make Series Fifty the perfect fit for an engaging space that meets the needs of today's workstyles.

Magna Design: Sustainable Beauty

Built upon an American-hewn heritage in the Pacific Northwest, Sustainable Beauty is the true essence of Magna Design and reflects our commitment to the fine craftsmanship of modular casegoods and conferencing solutions.



What begins as a fusion of select hardwood edges with environmentally preferred WoodPlus laminate surfaces, results in an unmistakable feeling of longevity and style to meet the highest standards for executive, managerial and collaborative workspaces. A compelling alternative to traditional veneer casegoods, Sustainable Beauty harnesses the warmth of wood and the superior performance of modern laminate technology to create furniture lines that transcend both classical concerns and contemporary expectations.

Freestanding, easy to modify and specify, Magna Design's comprehensive product solutions meet the demands of the modern workplace - masterfully designed and mindfully made.





HOW TO ORDER

DESKS		SECONDARY SURFACES	CREDENZAS	OVERHEAD STORAGE	STORAGE TOWERS	ACCESSORIES												
SINGLE PEDESTAL DESK																		
 <p>BOW FRONT Panel Base / Two File Right Hand Assembly Shown</p>	A / B	PRODUCT	EDGE	FINISHES														
		Storage Location, Storage Locks, Storage Pull, Wood Plus, 3mm, Edge Profile, Surface, Edge, Base Laminate																
	36 66	S50DSRF3666FF																
	36 72	S50DSRF3672FF																
 <p>RECTANGLE Panel Base / Two Box File Right Hand Assembly Shown</p>	30 54	S50DSRE3054FF	1549 1865															
	30 60	S50DSRE3060FF	1567 1882															
	30 66	S50DSRE3066FF	1590 1905															
	30 72	S50DSRE3072FF	1613 1928															
	36 66	S50DSRE3666FF	1736 1852															
 <p>RECTANGLE Panel Base / Two File Right Hand Assembly Shown</p>	30 54	S50DSRE3054FF	1549 1865															
	30 60	S50DSRE3060FF	1567 1882															
	30 66	S50DSRE3066FF	1590 1905															
	30 72	S50DSRE3072FF	1613 1928															
	36 66	S50DSRE3666FF	1736 1852															
PRODUCT NOTES																		
		Locks Randomly keyed locks "L" are standard on all storage units. Storage locks can be specified keyed alike "U" if required. Keyed alike option is listed in table.	EDGE & PULL															
		Modesty Panel Modesty Panel finish matches Base Laminate.	<table border="1"> <tr> <td>Edge Profile</td> <td>Edge Code</td> </tr> <tr> <td>Smooth</td> <td>S</td> </tr> <tr> <td>Beveled</td> <td>R</td> </tr> <tr> <td>NeoClass</td> <td>E</td> </tr> </table>				Edge Profile	Edge Code	Smooth	S	Beveled	R	NeoClass	E				
Edge Profile	Edge Code																	
Smooth	S																	
Beveled	R																	
NeoClass	E																	
		Grain Direction Grain direction is the length of the worksurface. Modesty Panel ships standard with horizontal grain.	<table border="1"> <tr> <td>Pull Style</td> <td>Pull Color</td> <td>Pull Code</td> </tr> <tr> <td>Black</td> <td>Black</td> <td>12</td> </tr> <tr> <td>Satin Chrome</td> <td>Satin Chrome</td> <td>13</td> </tr> <tr> <td>Black</td> <td>Satin Chrome</td> <td>31</td> </tr> </table>				Pull Style	Pull Color	Pull Code	Black	Black	12	Satin Chrome	Satin Chrome	13	Black	Satin Chrome	31
Pull Style	Pull Color	Pull Code																
Black	Black	12																
Satin Chrome	Satin Chrome	13																
Black	Satin Chrome	31																
		Crroments To add factory installed grommets please add "G" after the edge profile code above and add S56 for each desk. For additional details, see page 61.	<p>For a closer look at edge styles, visit our website:</p>															
<p>All desks shown ship ready to assemble. Desk hand is specified based on storage location. Pedestals are 15 inches wide. 36 inch deep Rectangle ships with a 30 inch deep Pedestal. Storage units with a bow drawer ship with a pencil tray. To order additional pencil trays see page 59.</p>																		

Product Dimensions

Product Code

Product Options

Left/Right, Modesty Panel, Edge Options, etc.

Finish Options

Laminates, Edges, etc.

Product Code Indicators



Boxes available to fill out a complete product code.

Index Tabs

Reference sections throughout the price list.

Upgrade Options and Notes

Reference important upgrades or notes that can affect your order.

DESKS		SECONDARY SURFACES	CREDENZAS	OVERHEAD STORAGE	STORAGE TOWERS	ACCESSORIES												
SINGLE PEDESTAL DESK																		
 <p>BOW FRONT Panel Base / Two File Right Hand Assembly Shown</p>	A / B	PRODUCT	EDGE	FINISHES														
		Storage Location, Storage Locks, Storage Pull, Wood Plus, 3mm, Edge Profile, Surface, Edge, Base Laminate																
	36 66	S50DSRF3666FF																
	36 72	S50DSRF3672FF																
 <p>RECTANGLE Panel Base / Two Box File Right Hand Assembly Shown</p>	30 54	S50DSRE3054FF	1549 1865															
	30 60	S50DSRE3060FF	1567 1882															
	30 66	S50DSRE3066FF	1590 1905															
	30 72	S50DSRE3072FF	1613 1928															
	36 66	S50DSRE3666FF	1736 1852															
 <p>RECTANGLE Panel Base / Two File Right Hand Assembly Shown</p>	30 54	S50DSRE3054FF	1549 1865															
	30 60	S50DSRE3060FF	1567 1882															
	30 66	S50DSRE3066FF	1590 1905															
	30 72	S50DSRE3072FF	1613 1928															
	36 66	S50DSRE3666FF	1736 1852															
PRODUCT NOTES																		
		Locks Randomly keyed locks "L" are standard on all storage units. Storage locks can be specified keyed alike "U" if required. Keyed alike option is listed in table.	EDGE & PULL															
		Modesty Panel Modesty Panel finish matches Base Laminate.	<table border="1"> <tr> <td>Edge Profile</td> <td>Edge Code</td> </tr> <tr> <td>Smooth</td> <td>S</td> </tr> <tr> <td>Beveled</td> <td>R</td> </tr> <tr> <td>NeoClass</td> <td>E</td> </tr> </table>				Edge Profile	Edge Code	Smooth	S	Beveled	R	NeoClass	E				
Edge Profile	Edge Code																	
Smooth	S																	
Beveled	R																	
NeoClass	E																	
		Grain Direction Grain direction is the length of the worksurface. Modesty Panel ships standard with horizontal grain.	<table border="1"> <tr> <td>Pull Style</td> <td>Pull Color</td> <td>Pull Code</td> </tr> <tr> <td>Black</td> <td>Black</td> <td>12</td> </tr> <tr> <td>Satin Chrome</td> <td>Satin Chrome</td> <td>13</td> </tr> <tr> <td>Black</td> <td>Satin Chrome</td> <td>31</td> </tr> </table>				Pull Style	Pull Color	Pull Code	Black	Black	12	Satin Chrome	Satin Chrome	13	Black	Satin Chrome	31
Pull Style	Pull Color	Pull Code																
Black	Black	12																
Satin Chrome	Satin Chrome	13																
Black	Satin Chrome	31																
		Crroments To add factory installed grommets please add "G" after the edge profile code above and add S56 for each desk. For additional details, see page 61.	<p>For a closer look at edge styles, visit our website:</p>															
<p>All desks shown ship ready to assemble. Desk hand is specified based on storage location. Pedestals are 15 inches wide. 36 inch deep Rectangle ships with a 30 inch deep Pedestal. Storage units with a bow drawer ship with a pencil tray. To order additional pencil trays see page 59.</p>																		

EXAMPLES

Complete product codes are pieced together in a similar fashion throughout each section. Please note that while working from left to right across the page, additional option codes or upgrades are listed on the lower portion of each page, and finish codes are found on page 66.

Desk **S50DSRE3060PF** | **L** | **L** | **12** | **P** | **S** | **CU** | **CU** | **CU**

Product Code Handhech Storage Locks Storage Pull Edge Material Edge Profile Surface Laminate Edge Finish Base Laminate

DESKS



Rectangle



Bow Front

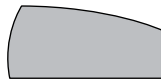

Wedge



Bullet

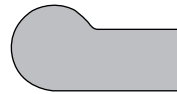

P Top

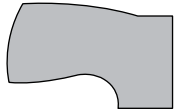

Conferring

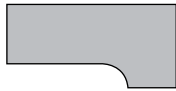

Extended
Corner

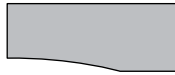

Arch In



Corner
Radius

DESKS

Shell Desks	06
Desks	07
Single Pedestal Support	12
Dual Pedestal Support	21

SHELL DESK

A / B		PRODUCT	EDGE			FINISHES		
			Wood Plus	3mm	Edge Profile	Surface	Edge	Base Laminate
		P	W	See Below				
		\$	\$					
24	54	S50SRE2454	923	1039	<input type="checkbox"/>	<input type="checkbox"/>	<input type="checkbox"/>	<input type="checkbox"/>
24	60	S50SRE2460	923	1039	<input type="checkbox"/>	<input type="checkbox"/>	<input type="checkbox"/>	<input type="checkbox"/>
24	66	S50SRE2466	1019	1135	<input type="checkbox"/>	<input type="checkbox"/>	<input type="checkbox"/>	<input type="checkbox"/>
24	72	S50SRE2472	1019	1135	<input type="checkbox"/>	<input type="checkbox"/>	<input type="checkbox"/>	<input type="checkbox"/>
30	54	S50SRE3054	1113	1228	<input type="checkbox"/>	<input type="checkbox"/>	<input type="checkbox"/>	<input type="checkbox"/>
30	60	S50SRE3060	1113	1228	<input type="checkbox"/>	<input type="checkbox"/>	<input type="checkbox"/>	<input type="checkbox"/>
30	66	S50SRE3066	1136	1251	<input type="checkbox"/>	<input type="checkbox"/>	<input type="checkbox"/>	<input type="checkbox"/>
30	72	S50SRE3072	1157	1272	<input type="checkbox"/>	<input type="checkbox"/>	<input type="checkbox"/>	<input type="checkbox"/>
36	66	S50SRE3666	1329	1444	<input type="checkbox"/>	<input type="checkbox"/>	<input type="checkbox"/>	<input type="checkbox"/>
36	72	S50SRE3672	1329	1444	<input type="checkbox"/>	<input type="checkbox"/>	<input type="checkbox"/>	<input type="checkbox"/>
36	66	S50SBF3666	1547	1663	<input type="checkbox"/>	<input type="checkbox"/>	<input type="checkbox"/>	<input type="checkbox"/>
36	72	S50SBF3672	1547	1663	<input type="checkbox"/>	<input type="checkbox"/>	<input type="checkbox"/>	<input type="checkbox"/>

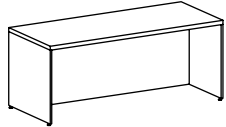

RECTANGLE

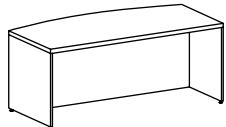

BOW FRONT

PRODUCT NOTES

SECONDARY SURFACES	23
OVERHEAD STORAGE	37
STORAGE TOWERS	45
ACCESSORIES	55
FINISHES	66

Grain Direction

Grain direction runs the length of the worksurface.

Modesty Panel finish matches Base Laminate finish specified and ships standard with horizontal grain direction.

Grommets

To add factory installed grommets place a "G" after the edge profile code above and add \$56 list for each desk.

Desk Details

Dimension information, optional grommet locations, and modesty panel placement are shown below.

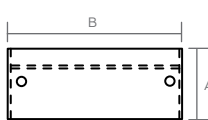

Rectangle

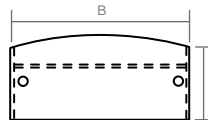

Bow Front

EDGE

Edge Profile		Edge Code
	Smooth	S
	Reeded	R
	NeoClassic	E

For a closer look at edge styles, visit our website.

DESK, NO STORAGE

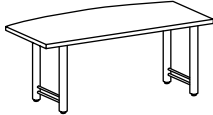
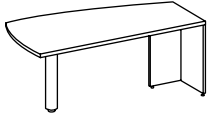
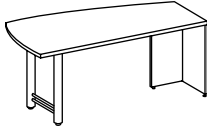
A / B	PRODUCT	EDGE			FINISHES						
		Left = L Right = R	Modesty Panel Full = F No = N	Wood Plus P	3mm W	Edge Profile <i>See Below</i>	Surface	Edge	Base Laminate	Modesty Panel <i>When Specified</i>	Base Powder
 BOW FRONT Double Column Base	S50DNBF3666D	-	<input type="checkbox"/>	1526	1642	<input type="checkbox"/>	<input type="checkbox"/> <input type="checkbox"/>	<input type="checkbox"/> <input type="checkbox"/>	-	<input type="checkbox"/> <input type="checkbox"/>	<input type="checkbox"/> <input type="checkbox"/>
	S50DNBF3672D	-	<input type="checkbox"/>	1561	1676	<input type="checkbox"/>	<input type="checkbox"/> <input type="checkbox"/>	<input type="checkbox"/> <input type="checkbox"/>	-	<input type="checkbox"/> <input type="checkbox"/>	<input type="checkbox"/> <input type="checkbox"/>
 WEDGE Single Column Base Right Hand Shown	S50DNWE3666S	<input type="checkbox"/>	N	1226	1341	<input type="checkbox"/>	<input type="checkbox"/> <input type="checkbox"/>	<input type="checkbox"/> <input type="checkbox"/>	<input type="checkbox"/> <input type="checkbox"/>	-	<input type="checkbox"/> <input type="checkbox"/>
	S50DNWE3672S	<input type="checkbox"/>	N	1259	1375	<input type="checkbox"/>	<input type="checkbox"/> <input type="checkbox"/>	<input type="checkbox"/> <input type="checkbox"/>	<input type="checkbox"/> <input type="checkbox"/>	-	<input type="checkbox"/> <input type="checkbox"/>
 WEDGE Double Column Base Right Hand Shown	S50DNWE3666D	<input type="checkbox"/>	<input type="checkbox"/>	1623	1739	<input type="checkbox"/>	<input type="checkbox"/> <input type="checkbox"/>	<input type="checkbox"/> <input type="checkbox"/>	<input type="checkbox"/> <input type="checkbox"/>	-	<input type="checkbox"/> <input type="checkbox"/>
	S50DNWE3672D	<input type="checkbox"/>	<input type="checkbox"/>	1657	1772	<input type="checkbox"/>	<input type="checkbox"/> <input type="checkbox"/>	<input type="checkbox"/> <input type="checkbox"/>	<input type="checkbox"/> <input type="checkbox"/>	-	<input type="checkbox"/> <input type="checkbox"/>

PRODUCT NOTES

SECONDARY SURFACES	23
OVERHEAD STORAGE	37
STORAGE TOWERS	45
ACCESSORIES	55
FINISHES	66

Left or Right?

When seated at a desk, if a Bridge or Return is to the users left, the worksurface is specified as a Left "L".

When a Bridge or Return is to the users right, the work-surface is specified as a Right "R".

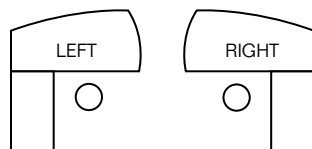

Modesty Panel

Modesty Panel finish matches Base Laminate.

Grain Direction

Grain direction runs the length of the worksurface. Modesty Panel ships standard with horizontal grain.

Grommets

To add factory installed grommets place a "G" after the edge profile code above and add \$56 list for each desk.

Desk Details

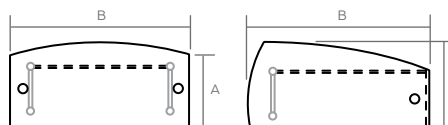

Dimension information, optional grommet locations, and modesty panel placement are shown below.



Bow Front, Double Column

Wedge, Double Column

EDGE

Edge Profile		Edge Code
	Smooth	S
	Reeded	R
	NeoClassic	E

For a closer look at edge styles, visit our website.

DESK, NO STORAGE

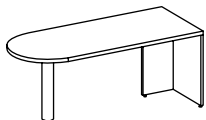

BULLET
Single Column Base
Right Hand Shown

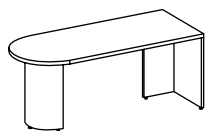

BULLET
Half Cylinder Base
Right Hand Shown

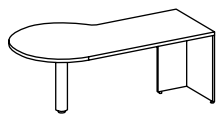

P-TOP
Single Column Base
Right Hand Shown

A / B		PRODUCT	Left = L Right = R	Modesty Panel Full = F No = N	EDGE	FINISHES					
					Wood Plus 3mm Edge Profile See Below	Surface Edge Base Laminate Base Powder					
					P \$	W \$					
30	60	S50DNBU3060S	<input type="checkbox"/>	N	1203	1318	<input type="checkbox"/>	<input type="checkbox"/>	<input type="checkbox"/>	<input type="checkbox"/>	<input type="checkbox"/>
30	66	S50DNBU3066S	<input type="checkbox"/>	N	1226	1341	<input type="checkbox"/>	<input type="checkbox"/>	<input type="checkbox"/>	<input type="checkbox"/>	<input type="checkbox"/>
30	72	S50DNBU3072S	<input type="checkbox"/>	N	1259	1375	<input type="checkbox"/>	<input type="checkbox"/>	<input type="checkbox"/>	<input type="checkbox"/>	<input type="checkbox"/>
30	60	S50DNBU3060H	<input type="checkbox"/>	<input type="checkbox"/>	1896	2011	<input type="checkbox"/>	<input type="checkbox"/>	<input type="checkbox"/>	<input type="checkbox"/>	-
30	66	S50DNBU3066H	<input type="checkbox"/>	<input type="checkbox"/>	1919	2034	<input type="checkbox"/>	<input type="checkbox"/>	<input type="checkbox"/>	<input type="checkbox"/>	-
30	72	S50DNBU3072H	<input type="checkbox"/>	<input type="checkbox"/>	1952	2068	<input type="checkbox"/>	<input type="checkbox"/>	<input type="checkbox"/>	<input type="checkbox"/>	-
42	66	S50DNPT4266S	<input type="checkbox"/>	N	1504	1620	<input type="checkbox"/>	<input type="checkbox"/>	<input type="checkbox"/>	<input type="checkbox"/>	<input type="checkbox"/>
42	72	S50DNPT4272S	<input type="checkbox"/>	N	1559	1674	<input type="checkbox"/>	<input type="checkbox"/>	<input type="checkbox"/>	<input type="checkbox"/>	<input type="checkbox"/>

PRODUCT NOTES

SECONDARY SURFACES	23
OVERHEAD STORAGE	37
STORAGE TOWERS	45
ACCESSORIES	55
FINISHES	66

Bullet Half Cylinder base is 18 inches wide.

P-Top Half Cylinder base is 24 inches wide.

Left or Right?

When seated at a desk, if a Bridge or Return is to the users left, the worksurface is specified as a Left "**L**".

When a Bridge or Return is to the users right, the worksurface is specified as a Right "**R**".

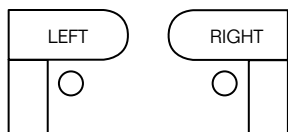

Modesty Panel

Modesty Panel finish matches Base Laminate.

Grain Direction

Grain direction runs the length of the worksurface.

Modesty Panel ships standard with horizontal grain.

Grommets

To add factory installed grommets place a "G" after the edge profile code above and add \$56 list for each desk.

Desk Details

Dimension information, optional grommet locations, and modesty panel placement are shown below.

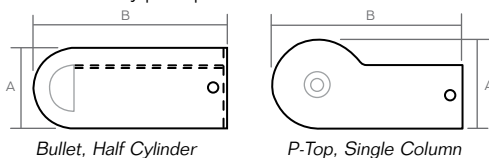

EDGE

Edge Profile		Edge Code
	Smooth	S
	Reeded	R
	NeoClassic	E

For a closer look at edge styles, visit our website.

DESK, NO STORAGE

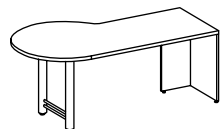

P-TOP
Double Column Base
Right Hand Shown

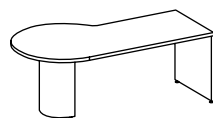

P-TOP
Half Cylinder Base
Right Hand Shown

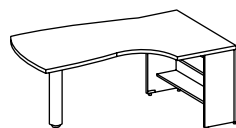

CONFERCING
Single Column Base
Right Hand Shown

A / B

42 66
42 72

42 66
42 72

42 72

PRODUCT	EDGE		FINISHES						
	Left = L Right = R	Modesty Panel Full = F No = N	Wood Plus P	3mm W	Edge Profile See Below	Surface	Edge	Base Laminate	Base Powder
S50DNPT4266D S50DNPT4272D	<input type="checkbox"/>	N	1902	2017	<input type="checkbox"/>	<input type="checkbox"/>	<input type="checkbox"/>	<input type="checkbox"/>	<input type="checkbox"/>
S50DNPT4266H S50DNPT4272H	<input type="checkbox"/>	<input type="checkbox"/>	2246 2300	2361 2416	<input type="checkbox"/>	<input type="checkbox"/>	<input type="checkbox"/>	<input type="checkbox"/>	-
S50DNCF4272S	<input type="checkbox"/>	N	1507	1622	<input type="checkbox"/>	<input type="checkbox"/>	<input type="checkbox"/>	<input type="checkbox"/>	<input type="checkbox"/>

PRODUCT NOTES

SECONDARY SURFACES	23
OVERHEAD STORAGE	37
STORAGE TOWERS	45
ACCESSORIES	55
FINISHES	66

P-Top Half Cylinder base is 24 inches wide.

Left or Right?

When seated at a desk, if a Bridge or Return is to the users left, the worksurface is specified as a Left "L".

When a Bridge or Return is to the users right, the worksurface is specified as a Right "R".

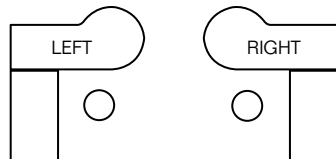

Modesty Panel

Modesty Panel finish matches Base Laminate.

Grain Direction

Grain direction runs the length of the worksurface.

Modesty Panel ships standard with horizontal grain.

Grommets

To add factory installed grommets place a "G" after the edge profile code above and add \$56 list for each desk.

Desk Details

Dimension information, optional grommet locations, and modesty panel placement are shown below.

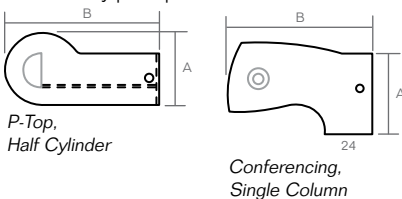

EDGE

Edge Profile		Edge Code
	Smooth	S
	Reeded	R
	NeoClassic	E

For a closer look at edge styles, visit our website.

DESK, NO STORAGE

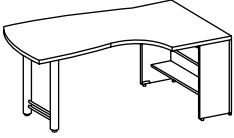
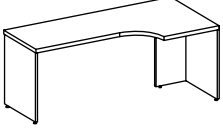
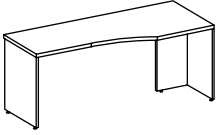
		PRODUCT			EDGE			FINISHES			
A / B		Left = L Right = R	Modesty Panel	Wood Plus	3mm	Edge Profile	Surface	Edge	Base Laminate	Base Powder	
			Full = F No = N	P	W	See Below					
				\$	\$						
	42 72			1904	2019		<input type="checkbox"/>	<input type="checkbox"/>	<input type="checkbox"/>	<input type="checkbox"/>	
CONFRENCING Double Column Base Right Hand Shown											
	36 60	<input type="checkbox"/>	<input type="checkbox"/>	1531	1646	<input type="checkbox"/>	<input type="checkbox"/>	<input type="checkbox"/>	<input type="checkbox"/>	-	
	36 66	<input type="checkbox"/>	<input type="checkbox"/>	1563	1679	<input type="checkbox"/>	<input type="checkbox"/>	<input type="checkbox"/>	<input type="checkbox"/>	-	
	36 72	<input type="checkbox"/>	<input type="checkbox"/>	1597	1712	<input type="checkbox"/>	<input type="checkbox"/>	<input type="checkbox"/>	<input type="checkbox"/>	-	
EXTENDED CORNER Right Hand Shown											
	30 60	<input type="checkbox"/>	<input type="checkbox"/>	1711	1827	<input type="checkbox"/>	<input type="checkbox"/>	<input type="checkbox"/>	<input type="checkbox"/>	-	
	30 66	<input type="checkbox"/>	<input type="checkbox"/>	1734	1850	<input type="checkbox"/>	<input type="checkbox"/>	<input type="checkbox"/>	<input type="checkbox"/>	-	
	30 72	<input type="checkbox"/>	<input type="checkbox"/>	1755	1870	<input type="checkbox"/>	<input type="checkbox"/>	<input type="checkbox"/>	<input type="checkbox"/>	-	
ARCH IN Right Hand Shown											

PRODUCT NOTES

SECONDARY SURFACES	23
OVERHEAD STORAGE	37
STORAGE TOWERS	45
ACCESSORIES	55
FINISHES	66

Left or Right?

When seated at a desk, if a Bridge or Return is to the users left, the worksurface is specified as a Left "L".

When a Bridge or Return is to the users right, the work-surface is specified as a Right "R".

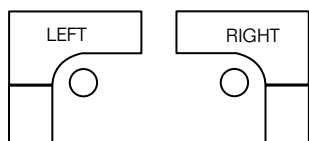

Modesty Panel

Modesty Panel finish matches Base Laminate.

Grain Direction

Grain direction runs the length of the worksurface.

Modesty Panel ships standard with horizontal grain.

Grommets



To add factory installed grommets place a "G" after the edge profile code above and add \$56 list for each desk.

Desk Details

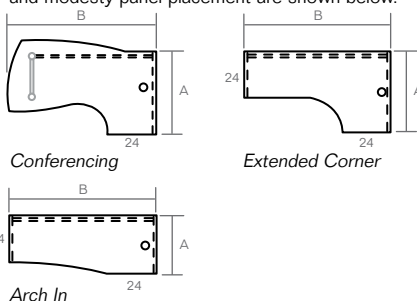
Dimension information, optional grommet locations, and modesty panel placement are shown below.



EDGE

Edge Profile		Edge Code
	Smooth	S
	Reeded	R
	NeoClassic	E

For a closer look at edge styles, visit our website.

DESK, NO STORAGE

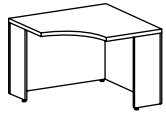

CORNER

A / B

24 42

PRODUCT	EDGE				FINISHES		
	Surface Grain	Wood Plus	3mm	Edge Profile	Surface	Edge	Base Laminate
		P	W	See Below			
S50DNCR2442	S	\$ 1678	\$ 1793	<input type="checkbox"/>	<input type="checkbox"/>	<input type="checkbox"/>	<input type="checkbox"/>

PRODUCT NOTES

SECONDARY SURFACES	23
OVERHEAD STORAGE	37
STORAGE TOWERS	45
ACCESSORIES	55
FINISHES	66

Modesty Panel

Modesty Panel finish matches Base Laminate.

Grain Direction

Corner surface grain ships as Side-to-Side standard. Modesty Panel ships standard with horizontal grain.

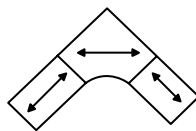

Corner Grain Direction

Grommets

To add factory installed grommets place a "G" after the edge profile code above and add \$56 list for each desk.

Desk Details

Dimension information, optional grommet locations are shown below.

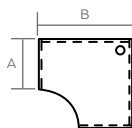

Corner

EDGE

Edge Profile		Edge Code
	Smooth	S
	Reeded	R
	NeoClassic	E

For a closer look at edge styles, visit our website.

SINGLE PEDESTAL DESK

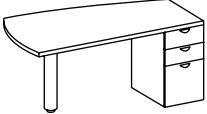
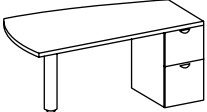
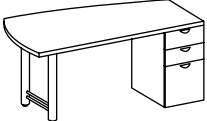
A / B		PRODUCT				EDGE			FINISHES				
		Surface Hand Left = L Right = R	Modesty Panel Full = F No = N	Storage Lock = L Alike = U	Storage Pull See Below	Wood Plus P	3mm W	Edge Profile See Below	Surface	Edge	Base Laminate	Base Powder	
 <p>WEDGE Single Column / Two Box, File Right Hand Surface & Assembly Shown</p>	36 66	S50DSWE3666SB	<input type="checkbox"/>	N	<input type="checkbox"/>	<input type="checkbox"/>	1957	2073	<input type="checkbox"/>	<input type="checkbox"/>	<input type="checkbox"/>	<input type="checkbox"/>	<input type="checkbox"/>
	36 72	S50DSWE3672SB	<input type="checkbox"/>	N	<input type="checkbox"/>	<input type="checkbox"/>	1991	2106	<input type="checkbox"/>	<input type="checkbox"/>	<input type="checkbox"/>	<input type="checkbox"/>	<input type="checkbox"/>
 <p>WEDGE Single Column / Two File Right Hand Surface & Assembly Shown</p>	36 66	S50DSWE3666SF	<input type="checkbox"/>	N	<input type="checkbox"/>	<input type="checkbox"/>	1957	2073	<input type="checkbox"/>	<input type="checkbox"/>	<input type="checkbox"/>	<input type="checkbox"/>	<input type="checkbox"/>
	36 72	S50DSWE3672SF	<input type="checkbox"/>	N	<input type="checkbox"/>	<input type="checkbox"/>	1991	2106	<input type="checkbox"/>	<input type="checkbox"/>	<input type="checkbox"/>	<input type="checkbox"/>	<input type="checkbox"/>
 <p>WEDGE Double Column / Two Box File Right Hand Surface & Assembly Shown</p>	36 66	S50DSWE3666DB	<input type="checkbox"/>	<input type="checkbox"/>	<input type="checkbox"/>	<input type="checkbox"/>	2354	2470	<input type="checkbox"/>	<input type="checkbox"/>	<input type="checkbox"/>	<input type="checkbox"/>	<input type="checkbox"/>
	36 72	S50DSWE3672DB	<input type="checkbox"/>	<input type="checkbox"/>	<input type="checkbox"/>	<input type="checkbox"/>	2388	2503	<input type="checkbox"/>	<input type="checkbox"/>	<input type="checkbox"/>	<input type="checkbox"/>	<input type="checkbox"/>

PRODUCT NOTES

SECONDARY SURFACES	23
OVERHEAD STORAGE	37
STORAGE TOWERS	45
ACCESSORIES	55
FINISHES	66

All desks shown ship ready to assemble.

Wedge surface handedness determines assembly orientation (ie: a left hand surface creates a left hand assembly only).

Pedestals are 15 inches wide.

Storage units with a box drawer ship with one pencil tray. To order additional pencil trays see page 59.

Locks

Randomly keyed locks "L" are standard on all storage units. Storage locks can be specified keyed alike "U" if required. Keyed alike option is field installed.

Modesty Panel

Modesty Panel finish matches Base Laminate.

Grain Direction

Grain direction runs the length of the worksurface.

Grommets

To add factory installed grommets place a "G" after the edge profile code above and add \$56 list for each desk.



Left or Right?

When seated at a desk, if a Bridge or Return is to the users left, the worksurface is specified as a Left "L".

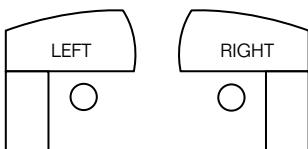

When a Bridge or Return is to the users right, the worksurface is specified as a Right "R".



EDGE & PULL

Edge Profile		Edge Code
	Smooth	S
	Reeded	R
	NeoClassic	E

For a closer look at edge styles, visit our website.

Pull Style	Pull Color	Pull Code
	Black	12
	Satin Chrome	13
	Black	30
	Satin Chrome	31

SINGLE PEDESTAL DESK

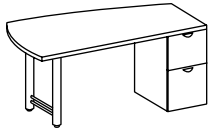

WEDGE
Double Column / Two File
Right Hand Surface & Assembly Shown

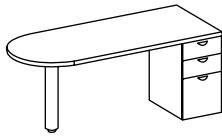

BULLET
Single Column / Two Box, File
Right Hand Assembly Shown

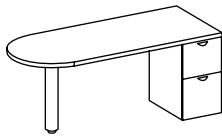

BULLET
Single Column / Two File
Right Hand Assembly Shown

A / B

36 66
36 72

30 60
30 66
30 72

30 60
30 66
30 72

PRODUCT		EDGE				FINISHES				
Surface Hand	Modesty Panel	Storage	Storage Pull	Wood Plus	3mm	Edge Profile	Surface	Edge	Base Laminate	Base Powder
				Left = L Right = R	Full = F No = N	Lock = L Alike = U				
				\$	\$					
				2354	2470					
				2388	2503					
				1957	2073					
				1957	2073					
				1991	2106					
				1957	2073					
				1957	2073					
				1991	2106					

PRODUCT NOTES

SECONDARY SURFACES	23
OVERHEAD STORAGE	37
STORAGE TOWERS	45
ACCESSORIES	55
FINISHES	66

All desks shown ship ready to assemble.

Wedge surface handedness determines assembly orientation (ie: a left hand surface creates a left hand assembly only).

Pedestals are 15 inches wide.

Storage units with a box drawer ship with one pencil tray. To order additional pencil trays see page 59.

Locks

Randomly keyed locks "L" are standard on all storage units. Storage locks can be specified keyed alike "U" if required. Keyed alike option is field installed.

Modesty Panel

Modesty Panel finish matches Base Laminate.

Grain Direction

Grain direction runs the length of the worksurface.

Grommets

To add factory installed grommets place a "G" after the edge profile code above and add \$56 list for each desk.

Left or Right?

When seated at a desk, if a Bridge or Return is to the users left, the worksurface is specified as a Left "L".

When a Bridge or Return is to the users right, the worksurface is specified as a Right "R".

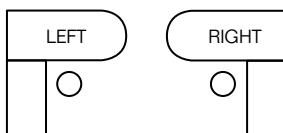

EDGE & PULL

Edge Profile		Edge Code
	Smooth	S
	Reeded	R
	NeoClassic	E

For a closer look at edge styles, visit our website.

Pull Style	Pull Color	Pull Code
	Black	12
	Satin Chrome	13
	Black	30
	Satin Chrome	31

SINGLE PEDESTAL DESK

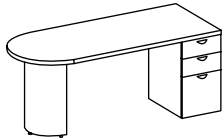

BULLET
Half Cylinder / Two Box, File
Right Hand Assembly Shown

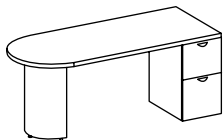

BULLET
Half Cylinder / Two File
Right Hand Assembly Shown

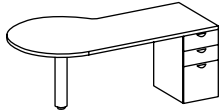

P-TOP
Single Column / Two Box, File
Right Hand Surface & Assembly Shown

A / B

30 60
30 66
30 72

PRODUCT		EDGE				FINISHES				
Surface Hand	Modesty Panel	Storage	Storage Pull	Wood Plus	3mm	Edge Profile	Surface	Edge	Base Laminate	Base Powder
				Left = L Right = R	Full = F No = N	Lock = L Alike = U				
				\$	\$					
				2699	2814					
				2699	2814					
				2732	2848					
				2699	2814					-
				2699	2814					-
				2732	2848					-
				2157	2272					
				2211	2327					

PRODUCT NOTES

SECONDARY SURFACES	23
OVERHEAD STORAGE	37
STORAGE TOWERS	45
ACCESSORIES	55
FINISHES	66

All desks shown ship ready to assemble.

P-Top surface handedness determines assembly orientation (ie: a left hand surface creates a left hand assembly only).

Pedestals are 15 inches wide.

Bullet Half Cylinder base is 18 inches wide.

Storage units with a box drawer ship with one pencil tray. To order additional pencil trays see page 59.

Locks

Randomly keyed locks "L" are standard on all storage units. Storage locks can be specified keyed alike "U" if required. Keyed alike option is field installed.

Modesty Panel

Modesty Panel finish matches Base Laminate.

Grain Direction

Grain direction runs the length of the worksurface.

Grommets

To add factory installed grommets place a "G" after the edge profile code above and add \$56 list for each desk.

Left or Right?

When seated at a desk, if a Bridge or Return is to the users left, the worksurface is specified as a Left "L".

When a Bridge or Return is to the users right, the worksurface is specified as a Right "R".

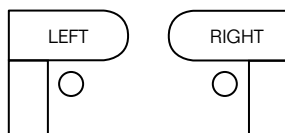

EDGE & PULL

Edge Profile		Edge Code
	Smooth	S
	Reeded	R
	NeoClassic	E

For a closer look at edge styles, visit our website.

Pull Style	Pull Color	Pull Code
	Black	12
	Satin Chrome	13
	Black	30
	Satin Chrome	31

SINGLE PEDESTAL DESK

A / B

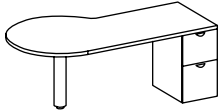

P-TOP

Single Column / Two File
Right Hand Surface & Assembly Shown

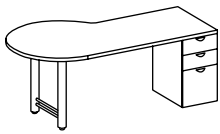

P-TOP

Double Column / Two Box, File
Right Hand Surface & Assembly Shown

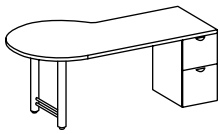

P-TOP

Double Column / Two File
Right Hand Surface & Assembly Shown

PRODUCT		EDGE				FINISHES						
A	B	Surface Hand Left = L Right = R	Modesty Panel Full = F No = N	Storage Lock = L Alike = U	Storage Pull See Below	Wood Plus	3mm	Edge Profile	Surface	Edge	Base Laminate	Base Powder
						P	W	See Below				
						\$	\$					
42	66	S50DSPT4266SF	<input type="checkbox"/>	N	<input type="checkbox"/>	<input type="checkbox"/>	<input type="checkbox"/>	<input type="checkbox"/>	<input type="checkbox"/>	<input type="checkbox"/>	<input type="checkbox"/>	<input type="checkbox"/>
42	72	S50DSPT4272SF	<input type="checkbox"/>	N	<input type="checkbox"/>	<input type="checkbox"/>	<input type="checkbox"/>	<input type="checkbox"/>	<input type="checkbox"/>	<input type="checkbox"/>	<input type="checkbox"/>	<input type="checkbox"/>
42	66	S50DSPT4266DB	<input type="checkbox"/>	N	<input type="checkbox"/>	<input type="checkbox"/>	<input type="checkbox"/>	<input type="checkbox"/>	<input type="checkbox"/>	<input type="checkbox"/>	<input type="checkbox"/>	<input type="checkbox"/>
42	72	S50DSPT4272DB	<input type="checkbox"/>	N	<input type="checkbox"/>	<input type="checkbox"/>	<input type="checkbox"/>	<input type="checkbox"/>	<input type="checkbox"/>	<input type="checkbox"/>	<input type="checkbox"/>	<input type="checkbox"/>
42	66	S50DSPT4266DF	<input type="checkbox"/>	N	<input type="checkbox"/>	<input type="checkbox"/>	<input type="checkbox"/>	<input type="checkbox"/>	<input type="checkbox"/>	<input type="checkbox"/>	<input type="checkbox"/>	<input type="checkbox"/>
42	72	S50DSPT4272DF	<input type="checkbox"/>	N	<input type="checkbox"/>	<input type="checkbox"/>	<input type="checkbox"/>	<input type="checkbox"/>	<input type="checkbox"/>	<input type="checkbox"/>	<input type="checkbox"/>	<input type="checkbox"/>

PRODUCT NOTES

SECONDARY SURFACES	23
OVERHEAD STORAGE	37
STORAGE TOWERS	45
ACCESSORIES	55
FINISHES	66

All desks shown ship ready to assemble.

P-Top surface handedness determines assembly orientation (ie: a left hand surface creates a left hand assembly only).

Pedestals are 15 inches wide.

Storage units with a box drawer ship with one pencil tray. To order additional pencil trays see page 59.

Locks

Randomly keyed locks "L" are standard on all storage units. Storage locks can be specified keyed alike "U" if required. Keyed alike option is field installed.

Modesty Panel

Modesty Panel finish matches Base Laminate.

Grain Direction

Grain direction runs the length of the worksurface.

Modesty Panel ships standard with horizontal grain.

Grommets

To add factory installed grommets place a "G" after the edge profile code above and add \$56 list for each desk.

Left or Right?

When seated at a desk, if a Bridge or Return is to the users left, the worksurface is specified as a Left "L".

When a Bridge or Return is to the users right, the worksurface is specified as a Right "R".

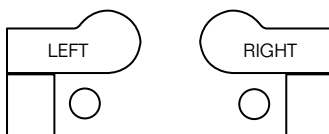

EDGE & PULL

Edge Profile		Edge Code
	Smooth	S
	Reeded	R
	NeoClassic	E

For a closer look at edge styles, visit our website.

Pull Style	Pull Color	Pull Code
	Black	12
	Satin Chrome	13
	Black	30
	Satin Chrome	31

SINGLE PEDESTAL DESK

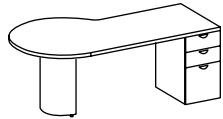

P-TOP
Half Cylinder / Two Box, File
Right Hand Surface & Assembly Shown

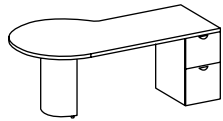

P-TOP
Half Cylinder / Two File
Right Hand Surface & Assembly Shown

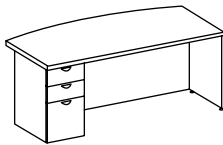

BOW FRONT
Panel Base / Two Box, File
Right Hand Assembly Shown

A / B

42 66
42 72

S50DSPT4266HB
S50DSPT4272HB

Surface Hand
Left = **L**
Right = **R**

Modesty Panel
Full = **F**
No = **N**

Storage
Lock = **L**
Alike = **U**

Storage Pull
See Below

Wood Plus
P

3mm
W

Edge Profile
See Below

\$ \$

2898 3014
2953 3068

Surface

Edge

Base Laminate

42 66
42 72

S50DSPT4266HF
S50DSPT4272HF

2898 3014
2953 3068

36 66
36 72

S50DSBF3666PB
S50DSBF3672PB

2015 2130
2142 2257

PRODUCT NOTES

SECONDARY SURFACES	23
OVERHEAD STORAGE	37
STORAGE TOWERS	45
ACCESSORIES	55
FINISHES	66

All desks shown ship ready to assemble.

P-Top surface handedness determines assembly orientation (ie: a left hand surface creates a left hand assembly only).

Pedestals are 15 inches wide.

P-Top Half Cylinder base is 24 inches wide.

Storage units with a box drawer ship with one pencil tray. To order additional pencil trays see page 59.

Locks

Randomly keyed locks "L" are standard on all storage units. Storage locks can be specified keyed alike "U" if required. Keyed alike option is field installed.

Modesty Panel

Modesty Panel finish matches Base Laminate.

Grain Direction

Grain direction runs the length of the worksurface.

Modesty Panel ships standard with horizontal grain.

Grommets

To add factory installed grommets place a "G" after the edge profile code above and add \$56 list for each desk.

Left or Right?

When seated at a desk, if a Bridge or Return is to the users left, the worksurface is specified as a Left "L".

When a Bridge or Return is to the users right, the worksurface is specified as a Right "R".

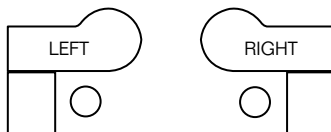

EDGE & PULL

Edge Profile		Edge Code
	Smooth	S
	Reeded	R
	NeoClassic	E

For a closer look at edge styles, visit our website.

Pull Style	Pull Color	Pull Code
	Black	12
	Satin Chrome	13
	Black	30
	Satin Chrome	31

SINGLE PEDESTAL DESK

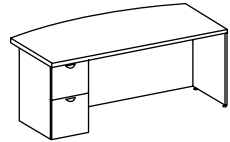

BOW FRONT

Panel Base / Two File
Right Hand Assembly Shown

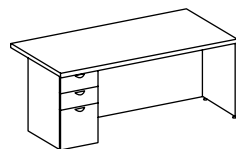

RECTANGLE

Panel Base / Two Box, File
Right Hand Assembly Shown

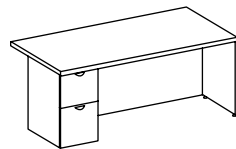

RECTANGLE

Panel Base / Two File
Right Hand Assembly Shown

A / B

36 66
36 72

30 54
30 60
30 66
30 72
36 66
36 72

30 54
30 60
30 66
30 72
36 66
36 72

PRODUCT		EDGE			FINISHES					
A / B	Product Code	Left = L Right = R	Storage Locks	Storage Pull	Wood Plus	3mm	Edge Profile	Surface	Edge	Base Laminate
		Lock = L Alike = U	See Below	P	W	See Below				
	S50DSBF3666PF	<input type="checkbox"/>	<input type="checkbox"/>	<input type="checkbox"/>	\$ 2015	\$ 2130	<input type="checkbox"/>	<input type="checkbox"/>	<input type="checkbox"/>	<input type="checkbox"/>
	S50DSBF3672PF	<input type="checkbox"/>	<input type="checkbox"/>	<input type="checkbox"/>	\$ 2142	\$ 2257	<input type="checkbox"/>	<input type="checkbox"/>	<input type="checkbox"/>	<input type="checkbox"/>
	S50DSRE3054PB	<input type="checkbox"/>	<input type="checkbox"/>	<input type="checkbox"/>	1549	1665	<input type="checkbox"/>	<input type="checkbox"/>	<input type="checkbox"/>	<input type="checkbox"/>
	S50DSRE3060PB	<input type="checkbox"/>	<input type="checkbox"/>	<input type="checkbox"/>	1567	1682	<input type="checkbox"/>	<input type="checkbox"/>	<input type="checkbox"/>	<input type="checkbox"/>
	S50DSRE3066PB	<input type="checkbox"/>	<input type="checkbox"/>	<input type="checkbox"/>	1590	1705	<input type="checkbox"/>	<input type="checkbox"/>	<input type="checkbox"/>	<input type="checkbox"/>
	S50DSRE3072PB	<input type="checkbox"/>	<input type="checkbox"/>	<input type="checkbox"/>	1613	1728	<input type="checkbox"/>	<input type="checkbox"/>	<input type="checkbox"/>	<input type="checkbox"/>
	S50DSRE3666PB	<input type="checkbox"/>	<input type="checkbox"/>	<input type="checkbox"/>	1736	1852	<input type="checkbox"/>	<input type="checkbox"/>	<input type="checkbox"/>	<input type="checkbox"/>
	S50DSRE3672PB	<input type="checkbox"/>	<input type="checkbox"/>	<input type="checkbox"/>	1868	1984	<input type="checkbox"/>	<input type="checkbox"/>	<input type="checkbox"/>	<input type="checkbox"/>
	S50DSRE3054PF	<input type="checkbox"/>	<input type="checkbox"/>	<input type="checkbox"/>	1549	1665	<input type="checkbox"/>	<input type="checkbox"/>	<input type="checkbox"/>	<input type="checkbox"/>
	S50DSRE3060PF	<input type="checkbox"/>	<input type="checkbox"/>	<input type="checkbox"/>	1567	1682	<input type="checkbox"/>	<input type="checkbox"/>	<input type="checkbox"/>	<input type="checkbox"/>
	S50DSRE3066PF	<input type="checkbox"/>	<input type="checkbox"/>	<input type="checkbox"/>	1590	1705	<input type="checkbox"/>	<input type="checkbox"/>	<input type="checkbox"/>	<input type="checkbox"/>
	S50DSRE3072PF	<input type="checkbox"/>	<input type="checkbox"/>	<input type="checkbox"/>	1613	1728	<input type="checkbox"/>	<input type="checkbox"/>	<input type="checkbox"/>	<input type="checkbox"/>
	S50DSRE3666PF	<input type="checkbox"/>	<input type="checkbox"/>	<input type="checkbox"/>	1736	1852	<input type="checkbox"/>	<input type="checkbox"/>	<input type="checkbox"/>	<input type="checkbox"/>
	S50DSRE3672PF	<input type="checkbox"/>	<input type="checkbox"/>	<input type="checkbox"/>	1868	1984	<input type="checkbox"/>	<input type="checkbox"/>	<input type="checkbox"/>	<input type="checkbox"/>

PRODUCT NOTES

SECONDARY SURFACES	23
OVERHEAD STORAGE	37
STORAGE TOWERS	45
ACCESSORIES	55
FINISHES	66

All desks shown ship ready to assemble.

Pedestals are 15 inches wide.

36 inch deep Rectangle ships with a 30 inch deep Pedestal.

Storage units with a box drawer ship with one pencil tray. To order additional pencil trays see page 59.

Locks

Randomly keyed locks "L" are standard on all storage units. Storage locks can be specified keyed alike "U" if required. Keyed alike option is field installed.

Modesty Panel

Modesty Panel finish matches Base Laminate.

Grain Direction

Grain direction runs the length of the worksurface. Modesty Panel ships standard with horizontal grain.

Grommets

To add factory installed grommets place a "G" after the edge profile code above and add \$56 list for each desk.

EDGE & PULL

Edge Profile		Edge Code
	Smooth	S
	Reeded	R
	NeoClassic	E

For a closer look at edge styles, visit our website.

Pull Style	Pull Color	Pull Code
	Black	12
	Satin Chrome	13
	Black	30
	Satin Chrome	31

SINGLE PEDESTAL DESK

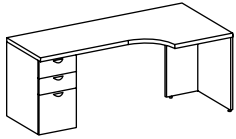

EXTENDED CORNER

Panel Base / Two Box File
Right Hand Surface & Assembly Shown

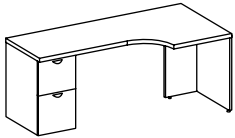

EXTENDED CORNER

Panel Base / Two File
Right Hand Surface & Assembly Shown

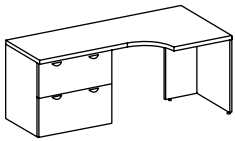

EXTENDED CORNER

Panel Base / Two Lateral
Right Hand Surface & Assembly Shown

A / B

PRODUCT		EDGE				FINISHES					
A	B	Surface Hand	Modesty Panel	Storage Lock	Storage Pull	Wood Plus	3mm	Edge Profile	Surface	Edge	Base Laminate
		Left = L Right = R	Full = F No = N	Lock = L Alike = U	See Below	P	W	See Below			
						\$	\$				
36	60	S50DSXC3660PB	<input type="checkbox"/>	<input type="checkbox"/>	<input type="checkbox"/>	<input type="checkbox"/>	<input type="checkbox"/>	<input type="checkbox"/>	<input type="checkbox"/>	<input type="checkbox"/>	<input type="checkbox"/>
36	66	S50DSXC3666PB	<input type="checkbox"/>	<input type="checkbox"/>	<input type="checkbox"/>	<input type="checkbox"/>	<input type="checkbox"/>	<input type="checkbox"/>	<input type="checkbox"/>	<input type="checkbox"/>	<input type="checkbox"/>
36	72	S50DSXC3672PB	<input type="checkbox"/>	<input type="checkbox"/>	<input type="checkbox"/>	<input type="checkbox"/>	<input type="checkbox"/>	<input type="checkbox"/>	<input type="checkbox"/>	<input type="checkbox"/>	<input type="checkbox"/>
36	60	S50DSXC3660PF	<input type="checkbox"/>	<input type="checkbox"/>	<input type="checkbox"/>	<input type="checkbox"/>	<input type="checkbox"/>	<input type="checkbox"/>	<input type="checkbox"/>	<input type="checkbox"/>	<input type="checkbox"/>
36	66	S50DSXC3666PF	<input type="checkbox"/>	<input type="checkbox"/>	<input type="checkbox"/>	<input type="checkbox"/>	<input type="checkbox"/>	<input type="checkbox"/>	<input type="checkbox"/>	<input type="checkbox"/>	<input type="checkbox"/>
36	72	S50DSXC3672PF	<input type="checkbox"/>	<input type="checkbox"/>	<input type="checkbox"/>	<input type="checkbox"/>	<input type="checkbox"/>	<input type="checkbox"/>	<input type="checkbox"/>	<input type="checkbox"/>	<input type="checkbox"/>
36	72	S50DSXC3672PL	<input type="checkbox"/>	<input type="checkbox"/>	<input type="checkbox"/>	<input type="checkbox"/>	<input type="checkbox"/>	<input type="checkbox"/>	<input type="checkbox"/>	<input type="checkbox"/>	<input type="checkbox"/>

PRODUCT NOTES

SECONDARY SURFACES	23
OVERHEAD STORAGE	37
STORAGE TOWERS	45
ACCESSORIES	55
FINISHES	66

All desks shown ship ready to assemble.

Extended Corner surface handedness determines assembly orientation (ie: a left hand surface creates a left hand assembly only).

Pedestals are 15 inches wide.

Lateral cabinets are 30 inches wide.

Storage units with a box drawer ship with one pencil tray. To order additional pencil trays see page 59.

Locks

Randomly keyed locks "L" are standard on all storage units. Storage locks can be specified keyed alike "U" if required. Keyed alike option is field installed.

Modesty Panel

Modesty Panel finish matches Base Laminate.

Grain Direction

Grain direction runs the length of the worksurface.

Grommets

To add factory installed grommets place a "G" after the edge profile code above and add \$56 list for each desk.

Left or Right?

When seated at a desk, if a Bridge or Return is to the users left, the worksurface is specified as a Left "L".

When a Bridge or Return is to the users right, the worksurface is specified as a Right "R".

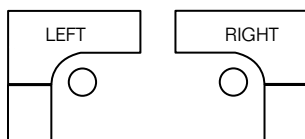

EDGE & PULL

Edge Profile		Edge Code
	Smooth	S
	Reeded	R
	NeoClassic	E

For a closer look at edge styles, visit our website.

Pull Style	Pull Color	Pull Code
	Black	12
	Satin Chrome	13
	Black	30
	Satin Chrome	31

SINGLE PEDESTAL DESK

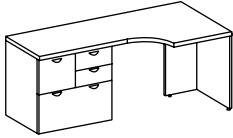

EXTENDED CORNER
Panel Base / Combo
Right Hand Surface & Assembly Shown

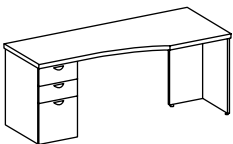

ARCH IN
Panel Base / Two Box File
Right Hand Surface & Assembly Shown

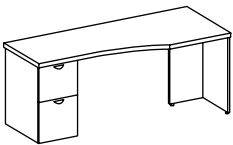

ARCH IN
Panel Base / Two File
Right Hand Surface & Assembly Shown

A / B

36 72

30 60
30 66
30 72

30 60
30 66
30 72

PRODUCT	EDGE				FINISHES					
	Surface Hand Left = L Right = R	Modesty Panel Full = F No = N	Storage Lock = L Alike = U	Storage Pull See Below	Wood Plus P	3mm W	Edge Profile See Below	Surface	Edge	Base Laminate
S50DSXC3672PC	<input type="checkbox"/>	<input type="checkbox"/>	<input type="checkbox"/>	<input type="checkbox"/>	2956	3072	<input type="checkbox"/>	<input type="checkbox"/>	<input type="checkbox"/>	<input type="checkbox"/>
S50DSAI3060PB	<input type="checkbox"/>	<input type="checkbox"/>	<input type="checkbox"/>	<input type="checkbox"/>	1971	2086	<input type="checkbox"/>	<input type="checkbox"/>	<input type="checkbox"/>	<input type="checkbox"/>
S50DSAI3066PB	<input type="checkbox"/>	<input type="checkbox"/>	<input type="checkbox"/>	<input type="checkbox"/>	1994	2110	<input type="checkbox"/>	<input type="checkbox"/>	<input type="checkbox"/>	<input type="checkbox"/>
S50DSAI3072PB	<input type="checkbox"/>	<input type="checkbox"/>	<input type="checkbox"/>	<input type="checkbox"/>	2017	2133	<input type="checkbox"/>	<input type="checkbox"/>	<input type="checkbox"/>	<input type="checkbox"/>
S50DSAI3060PF	<input type="checkbox"/>	<input type="checkbox"/>	<input type="checkbox"/>	<input type="checkbox"/>	1971	2086	<input type="checkbox"/>	<input type="checkbox"/>	<input type="checkbox"/>	<input type="checkbox"/>
S50DSAI3066PF	<input type="checkbox"/>	<input type="checkbox"/>	<input type="checkbox"/>	<input type="checkbox"/>	1994	2110	<input type="checkbox"/>	<input type="checkbox"/>	<input type="checkbox"/>	<input type="checkbox"/>
S50DSAI3072PF	<input type="checkbox"/>	<input type="checkbox"/>	<input type="checkbox"/>	<input type="checkbox"/>	2017	2133	<input type="checkbox"/>	<input type="checkbox"/>	<input type="checkbox"/>	<input type="checkbox"/>

PRODUCT NOTES

SECONDARY SURFACES	23
OVERHEAD STORAGE	37
STORAGE TOWERS	45
ACCESSORIES	55
FINISHES	66

All desks shown ship ready to assemble.

Extended Corner and Arch In surface handedness determines assembly orientation (ie: a left hand surface creates a left hand assembly only).

Pedestals are 15 inches wide.

Combo cabinets are 30 inches wide.

Combo shipped will be based on hand specified. Box drawers will always be oriented closest to the user.

Storage units with a box drawer ship with one pencil tray. To order additional pencil trays see page 59.

Locks

Randomly keyed locks "L" are standard on all storage units. Storage locks can be specified keyed alike "U" if required. Keyed alike option is field installed.

Modesty Panel

Modesty Panel finish matches Base Laminate.

Grain Direction

Grain direction runs the length of the worksurface. Modesty Panel ships standard with horizontal grain.

Grommets

To add factory installed grommets place a "G" after the edge profile code above and add \$56 list for each desk.

Left or Right?

When seated at a desk, if a Bridge or Return is to the users left, the worksurface is specified as a Left "L".

When a Bridge or Return is to the users right, the worksurface is specified as a Right "R".

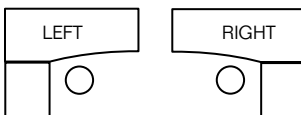

EDGE & PULL

Edge Profile		Edge Code
	Smooth	S
	Reeded	R
	NeoClassic	E

For a closer look at edge styles, visit our website.

Pull Style	Pull Color	Pull Code
	Black	12
	Satin Chrome	13
	Black	30
	Satin Chrome	31

SINGLE PEDESTAL DESK

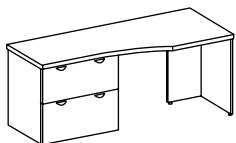

ARCH IN
Panel Base / Two Lateral
Right Hand Surface & Assembly Shown

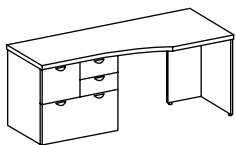

ARCH IN
Panel Base / Combo
Right Hand Surface & Assembly Shown

A / B

		PRODUCT				EDGE			FINISHES		
		Surface Hand	Modesty Panel	Storage	Storage Pull	Wood Plus	3mm	Edge Profile	Surface	Edge	Base Laminate
		Left = L Right = R	Full = F No = N	Lock = L Alike = U	See Below	P	W	See Below			
						\$	\$				
30	66	S50DSAI3066PL	<input type="checkbox"/>	<input type="checkbox"/>	<input type="checkbox"/>	<input type="checkbox"/>	<input type="checkbox"/>	<input type="checkbox"/>	<input type="checkbox"/>	<input type="checkbox"/>	<input type="checkbox"/>
30	72	S50DSAI3072PL	<input type="checkbox"/>	<input type="checkbox"/>	<input type="checkbox"/>	<input type="checkbox"/>	<input type="checkbox"/>	<input type="checkbox"/>	<input type="checkbox"/>	<input type="checkbox"/>	<input type="checkbox"/>
30	66	S50DSAI3066PC	<input type="checkbox"/>	<input type="checkbox"/>	<input type="checkbox"/>	<input type="checkbox"/>	<input type="checkbox"/>	<input type="checkbox"/>	<input type="checkbox"/>	<input type="checkbox"/>	<input type="checkbox"/>
30	72	S50DSAI3072PC	<input type="checkbox"/>	<input type="checkbox"/>	<input type="checkbox"/>	<input type="checkbox"/>	<input type="checkbox"/>	<input type="checkbox"/>	<input type="checkbox"/>	<input type="checkbox"/>	<input type="checkbox"/>

PRODUCT NOTES

SECONDARY SURFACES	23
OVERHEAD STORAGE	37
STORAGE TOWERS	45
ACCESSORIES	55
FINISHES	66

All desks shown ship ready to assemble.

Arch In surface handedness determines assembly orientation (ie: a left hand surface creates a left hand assembly only).

Two Lateral and Combo cabinets are 30 inches wide.

Combo shipped will be based on hand specified. Box drawers will always be oriented closest to the user.

Storage units with a box drawer ship with one pencil tray. To order additional pencil trays see page 59.

Locks

Randomly keyed locks "L" are standard on all storage units. Storage locks can be specified keyed alike "U" if required. Keyed alike option is field installed.

Modesty Panel

Modesty Panel finish matches Base Laminate.

Grain Direction

Grain direction runs the length of the worksurface.

Modesty Panel ships standard with horizontal grain.

Grommets

To add factory installed grommets place a "G" after the edge profile code above and add \$56 list for each desk.

Left or Right?

When seated at a desk, if a Bridge or Return is to the users left, the worksurface is specified as a Left "L".

When a Bridge or Return is to the users right, the worksurface is specified as a Right "R".

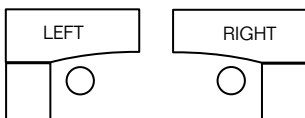

EDGE & PULL

Edge Profile		Edge Code
	Smooth	S
	Reeded	R
	NeoClassic	E

For a closer look at edge styles, visit our website.

Pull Style	Pull Color	Pull Code
	Black	12
	Satin Chrome	13
	Black	30
	Satin Chrome	31

DUAL PEDESTAL DESK

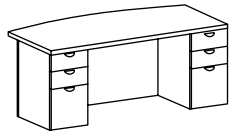

BOW FRONT

Two Box, File / Two Box, File

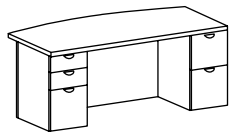

BOW FRONT

Two Box, File / Two File

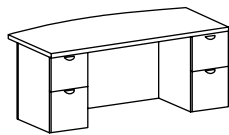

BOW FRONT

Two File / Two File

A / B

36 72

PRODUCT

S50DDBF3672BB

Storage
Lock = **L**
Alike = **U**

Storage
Pull
See
Below

EDGE

Wood
Plus
P

3mm
W

Edge
Profile
See
Below

FINISHES

Surface

Edge

Base
Laminate

36 72

S50DDBF3672BF

36 72

S50DDBF3672FF

PRODUCT NOTES

SECONDARY SURFACES	23
OVERHEAD STORAGE	37
STORAGE TOWERS	45
ACCESSORIES	55
FINISHES	66

All desks shown ship ready to assemble.

Two Box File / Two File storage units are interchangeable and may be assembled on either side of the desk.

Pedestals are 15 inches wide.

Pedestals can be installed based on user preference.

Storage units with a box drawer ship with one pencil tray. To order additional pencil trays see page 59.

Locks

Randomly keyed locks "L" are standard on all storage units. Storage locks can be specified keyed alike "U" if required. Keyed alike option is field installed.

Grain Direction

Grain direction runs the length of the worksurface.

Grommets

To add factory installed grommets place a "G" after the edge profile code above and add \$56 list for each desk.

EDGE & PULL

Edge Profile		Edge Code
	Smooth	S
	Reeded	R
	NeoClassic	E

For a closer look at edge styles, visit our website.

Pull Style	Pull Color	Pull Code
	Black	12
	Satin Chrome	13
	Black	30
	Satin Chrome	31

DUAL PEDESTAL DESK

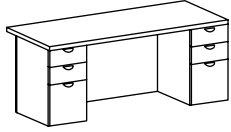

RECTANGLE
Two Box, File / Two Box, File

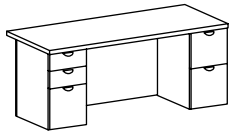

RECTANGLE
Two Box, File / Two File

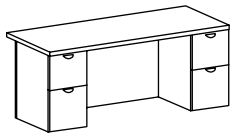

RECTANGLE
Two File / Two File



A / B		PRODUCT	Storage		EDGE			FINISHES		
			Lock = L Alike = U	Storage Pull See Below	Wood Plus P	3mm W	Edge Profile See Below	Surface	Edge	Base Laminate
30	72	S50DDRE3072BB	<input type="checkbox"/>	<input type="checkbox"/>	\$ 2453	\$ 2568	<input type="checkbox"/>	<input type="checkbox"/>	<input type="checkbox"/>	<input type="checkbox"/>
36	72	S50DDRE3672BB	<input type="checkbox"/>	<input type="checkbox"/>	2507	2622	<input type="checkbox"/>	<input type="checkbox"/>	<input type="checkbox"/>	<input type="checkbox"/>
30	72	S50DDRE3072BF	<input type="checkbox"/>	<input type="checkbox"/>	2453	2568	<input type="checkbox"/>	<input type="checkbox"/>	<input type="checkbox"/>	<input type="checkbox"/>
36	72	S50DDRE3672BF	<input type="checkbox"/>	<input type="checkbox"/>	2507	2622	<input type="checkbox"/>	<input type="checkbox"/>	<input type="checkbox"/>	<input type="checkbox"/>
30	72	S50DDRE3072FF	<input type="checkbox"/>	<input type="checkbox"/>	2453	2568	<input type="checkbox"/>	<input type="checkbox"/>	<input type="checkbox"/>	<input type="checkbox"/>
36	72	S50DDRE3672FF	<input type="checkbox"/>	<input type="checkbox"/>	2507	2622	<input type="checkbox"/>	<input type="checkbox"/>	<input type="checkbox"/>	<input type="checkbox"/>

PRODUCT NOTES

SECONDARY SURFACES	23
OVERHEAD STORAGE	37
STORAGE TOWERS	45
ACCESSORIES	55
FINISHES	66

All desks shown ship ready to assemble.

Two Box File / Two File storage units are interchangeable and may be assembled on either side of the desk.

Pedestals are 15 inches wide.

36 inch deep Rectangle ships with a 30 inch deep Pedestal.

Pedestals can be installed based on user preference.

Storage units with a box drawer ship with one pencil tray. To order additional pencil trays see page 59.

EDGE & PULL

Edge Profile		Edge Code
	Smooth	S
	Reeded	R
	NeoClassic	E

For a closer look at edge styles, visit our website.

Pull Style	Pull Color	Pull Code
	Black	12
	Satin Chrome	13
	Black	30
	Satin Chrome	31

SECONDARY SURFACES



Rectangle
Return



Rectangle
Bridge



Wedge
Extension



Bullet
Extension



P Top
Extension

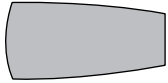

Fan
Extension



Rectangle
Extension

SECONDARY SURFACES

Return	24
Bridge	26
Extension	27
Companion Table	30

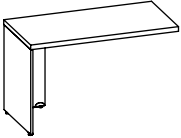
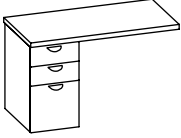
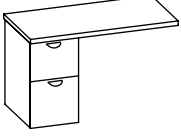
RETURN		PRODUCT					EDGE			FINISHES			
A / B			Left = L Right = R	Modesty Panel Yes = F No = N	Storage Lock = L Alike = U	Storage Pull See Below	Surface Grain Side = S Front = F	Wood Plus P	3mm W	Edge Profile See Below	Surface	Edge	Base Laminate
									\$	\$			
 <p>RECTANGLE RETURN No Storage Left Hand Shown</p>	24 30	S50RNRE2430	<input type="checkbox"/>	<input type="checkbox"/>	-	-	<input type="checkbox"/>	748	863	<input type="checkbox"/>	<input type="checkbox"/>	<input type="checkbox"/>	<input type="checkbox"/>
	24 36	S50RNRE2436	<input type="checkbox"/>	<input type="checkbox"/>	-	-	<input type="checkbox"/>	764	879	<input type="checkbox"/>	<input type="checkbox"/>	<input type="checkbox"/>	<input type="checkbox"/>
	24 42	S50RNRE2442	<input type="checkbox"/>	<input type="checkbox"/>	-	-	<input type="checkbox"/>	780	896	<input type="checkbox"/>	<input type="checkbox"/>	<input type="checkbox"/>	<input type="checkbox"/>
	24 48	S50RNRE2448	<input type="checkbox"/>	<input type="checkbox"/>	-	-	<input type="checkbox"/>	780	896	<input type="checkbox"/>	<input type="checkbox"/>	<input type="checkbox"/>	<input type="checkbox"/>
	24 54	S50RNRE2454	<input type="checkbox"/>	<input type="checkbox"/>	-	-	<input type="checkbox"/>	990	1106	<input type="checkbox"/>	<input type="checkbox"/>	<input type="checkbox"/>	<input type="checkbox"/>
	24 60	S50RNRE2460	<input type="checkbox"/>	<input type="checkbox"/>	-	-	<input type="checkbox"/>	1008	1123	<input type="checkbox"/>	<input type="checkbox"/>	<input type="checkbox"/>	<input type="checkbox"/>
 <p>RECTANGLE RETURN Two Box File Pedestal Left Hand Assembly Shown</p>	24 30	S50RSRE2430B	-	<input type="checkbox"/>	<input type="checkbox"/>	<input type="checkbox"/>	<input type="checkbox"/>	1400	1516	<input type="checkbox"/>	<input type="checkbox"/>	<input type="checkbox"/>	<input type="checkbox"/>
	24 36	S50RSRE2436B	-	<input type="checkbox"/>	<input type="checkbox"/>	<input type="checkbox"/>	<input type="checkbox"/>	1417	1532	<input type="checkbox"/>	<input type="checkbox"/>	<input type="checkbox"/>	<input type="checkbox"/>
	24 42	S50RSRE2442B	-	<input type="checkbox"/>	<input type="checkbox"/>	<input type="checkbox"/>	<input type="checkbox"/>	1433	1548	<input type="checkbox"/>	<input type="checkbox"/>	<input type="checkbox"/>	<input type="checkbox"/>
	24 48	S50RSRE2448B	-	<input type="checkbox"/>	<input type="checkbox"/>	<input type="checkbox"/>	<input type="checkbox"/>	1433	1548	<input type="checkbox"/>	<input type="checkbox"/>	<input type="checkbox"/>	<input type="checkbox"/>
	24 54	S50RSRE2454B	-	<input type="checkbox"/>	<input type="checkbox"/>	<input type="checkbox"/>	<input type="checkbox"/>	1449	1564	<input type="checkbox"/>	<input type="checkbox"/>	<input type="checkbox"/>	<input type="checkbox"/>
	24 60	S50RSRE2460B	-	<input type="checkbox"/>	<input type="checkbox"/>	<input type="checkbox"/>	<input type="checkbox"/>	1660	1776	<input type="checkbox"/>	<input type="checkbox"/>	<input type="checkbox"/>	<input type="checkbox"/>
	24 66	S50RSRE2466B	-	<input type="checkbox"/>	<input type="checkbox"/>	<input type="checkbox"/>	S	1683	1799	<input type="checkbox"/>	<input type="checkbox"/>	<input type="checkbox"/>	<input type="checkbox"/>
	24 72	S50RSRE2472B	-	<input type="checkbox"/>	<input type="checkbox"/>	<input type="checkbox"/>	S	1706	1822	<input type="checkbox"/>	<input type="checkbox"/>	<input type="checkbox"/>	<input type="checkbox"/>
 <p>RECTANGLE RETURN Two File Pedestal Left Hand Assembly Shown</p>	24 30	S50RSRE2430F	-	<input type="checkbox"/>	<input type="checkbox"/>	<input type="checkbox"/>	<input type="checkbox"/>	1400	1516	<input type="checkbox"/>	<input type="checkbox"/>	<input type="checkbox"/>	<input type="checkbox"/>
	24 36	S50RSRE2436F	-	<input type="checkbox"/>	<input type="checkbox"/>	<input type="checkbox"/>	<input type="checkbox"/>	1417	1532	<input type="checkbox"/>	<input type="checkbox"/>	<input type="checkbox"/>	<input type="checkbox"/>
	24 42	S50RSRE2442F	-	<input type="checkbox"/>	<input type="checkbox"/>	<input type="checkbox"/>	<input type="checkbox"/>	1433	1548	<input type="checkbox"/>	<input type="checkbox"/>	<input type="checkbox"/>	<input type="checkbox"/>
	24 48	S50RSRE2448F	-	<input type="checkbox"/>	<input type="checkbox"/>	<input type="checkbox"/>	<input type="checkbox"/>	1433	1548	<input type="checkbox"/>	<input type="checkbox"/>	<input type="checkbox"/>	<input type="checkbox"/>
	24 54	S50RSRE2454F	-	<input type="checkbox"/>	<input type="checkbox"/>	<input type="checkbox"/>	<input type="checkbox"/>	1449	1564	<input type="checkbox"/>	<input type="checkbox"/>	<input type="checkbox"/>	<input type="checkbox"/>
	24 60	S50RSRE2460F	-	<input type="checkbox"/>	<input type="checkbox"/>	<input type="checkbox"/>	<input type="checkbox"/>	1660	1776	<input type="checkbox"/>	<input type="checkbox"/>	<input type="checkbox"/>	<input type="checkbox"/>
	24 66	S50RSRE2466F	-	<input type="checkbox"/>	<input type="checkbox"/>	<input type="checkbox"/>	S	1683	1799	<input type="checkbox"/>	<input type="checkbox"/>	<input type="checkbox"/>	<input type="checkbox"/>
	24 72	S50RSRE2472F	-	<input type="checkbox"/>	<input type="checkbox"/>	<input type="checkbox"/>	S	1706	1822	<input type="checkbox"/>	<input type="checkbox"/>	<input type="checkbox"/>	<input type="checkbox"/>

PRODUCT NOTES

DESKS	05
ACCESSORIES	55
FINISHES	66

All Returns must be attached to a Series 50 desk, the hardware required is included.

Pedestals are 15 inches wide.

Storage units with a box drawer ship with one pencil tray. To order additional pencil trays see page 59.

Locks

Randomly keyed locks "L" are standard on all storage units. Storage locks can be specified keyed alike "U" if required. Keyed alike option is field installed.

Modesty Panel

Modesty Panel finish matches Base Laminate.

Grain Direction

Surface grain direction can be specified front-to-back "F" or side-to-side "S", 66 and 72 inch wide Returns can only receive a side-to-side grain direction.

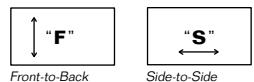



When surface grain is specified as side-to-side "S" Modesty Panel ships with horizontal grain.

When surface grain is specified as front-to-back "F" Modesty Panel ships with vertical grain.



Grommets

To add factory installed grommets place a "G" after the edge profile code above and add \$56 list for each desk.

EDGE & PULL

Edge Profile		Edge Code
	Smooth	S
	Reeded	R
	NeoClassic	E

For a closer look at edge styles, visit our website.

Pull Style	Pull Color	Pull Code
	Black	12
	Satin Chrome	13
	Black	30
	Satin Chrome	31

RETURN

RETURN		PRODUCT						EDGE			FINISHES		
A / B			Left = L Right = R	Modesty Panel	Storage	Storage Pull	Surface Grain	Wood Plus	3mm	Edge Profile	Surface	Edge	Base Laminate
			Yes = F No = N	Lock = L Alike = U	See Below	Side = S Front = F	P	W	See Below				
								\$	\$				
24 36		S50RSRE2436L	-	<input type="checkbox"/>	<input type="checkbox"/>	<input type="checkbox"/>	<input type="checkbox"/>	1828	1943	<input type="checkbox"/>	<input type="checkbox"/>	<input type="checkbox"/>	<input type="checkbox"/>
24 42		S50RSRE2442L	-	<input type="checkbox"/>	<input type="checkbox"/>	<input type="checkbox"/>	<input type="checkbox"/>	1844	1959	<input type="checkbox"/>	<input type="checkbox"/>	<input type="checkbox"/>	<input type="checkbox"/>
24 48		S50RSRE2448L	-	<input type="checkbox"/>	<input type="checkbox"/>	<input type="checkbox"/>	<input type="checkbox"/>	1844	1959	<input type="checkbox"/>	<input type="checkbox"/>	<input type="checkbox"/>	<input type="checkbox"/>
24 54		S50RSRE2454L	-	<input type="checkbox"/>	<input type="checkbox"/>	<input type="checkbox"/>	<input type="checkbox"/>	1860	1976	<input type="checkbox"/>	<input type="checkbox"/>	<input type="checkbox"/>	<input type="checkbox"/>
24 60		S50RSRE2460L	-	<input type="checkbox"/>	<input type="checkbox"/>	<input type="checkbox"/>	<input type="checkbox"/>	1877	1993	<input type="checkbox"/>	<input type="checkbox"/>	<input type="checkbox"/>	<input type="checkbox"/>
24 66		S50RSRE2466L	-	<input type="checkbox"/>	<input type="checkbox"/>	<input type="checkbox"/>	S	1900	2016	<input type="checkbox"/>	<input type="checkbox"/>	<input type="checkbox"/>	<input type="checkbox"/>
24 72		S50RSRE2472L	-	<input type="checkbox"/>	<input type="checkbox"/>	<input type="checkbox"/>	S	1924	2039	<input type="checkbox"/>	<input type="checkbox"/>	<input type="checkbox"/>	<input type="checkbox"/>
24 36		S50RSRE2436C	<input type="checkbox"/>	<input type="checkbox"/>	<input type="checkbox"/>	<input type="checkbox"/>	<input type="checkbox"/>	2059	2174	<input type="checkbox"/>	<input type="checkbox"/>	<input type="checkbox"/>	<input type="checkbox"/>
24 42		S50RSRE2442C	<input type="checkbox"/>	<input type="checkbox"/>	<input type="checkbox"/>	<input type="checkbox"/>	<input type="checkbox"/>	2075	2190	<input type="checkbox"/>	<input type="checkbox"/>	<input type="checkbox"/>	<input type="checkbox"/>
24 48		S50RSRE2448C	<input type="checkbox"/>	<input type="checkbox"/>	<input type="checkbox"/>	<input type="checkbox"/>	<input type="checkbox"/>	2075	2190	<input type="checkbox"/>	<input type="checkbox"/>	<input type="checkbox"/>	<input type="checkbox"/>
24 54		S50RSRE2454C	<input type="checkbox"/>	<input type="checkbox"/>	<input type="checkbox"/>	<input type="checkbox"/>	<input type="checkbox"/>	2091	2207	<input type="checkbox"/>	<input type="checkbox"/>	<input type="checkbox"/>	<input type="checkbox"/>
24 60		S50RSRE2460C	<input type="checkbox"/>	<input type="checkbox"/>	<input type="checkbox"/>	<input type="checkbox"/>	<input type="checkbox"/>	2108	2224	<input type="checkbox"/>	<input type="checkbox"/>	<input type="checkbox"/>	<input type="checkbox"/>
24 66		S50RSRE2466C	<input type="checkbox"/>	<input type="checkbox"/>	<input type="checkbox"/>	<input type="checkbox"/>	S	2131	2247	<input type="checkbox"/>	<input type="checkbox"/>	<input type="checkbox"/>	<input type="checkbox"/>
24 72		S50RSRE2472C	<input type="checkbox"/>	<input type="checkbox"/>	<input type="checkbox"/>	<input type="checkbox"/>	S	2155	2270	<input type="checkbox"/>	<input type="checkbox"/>	<input type="checkbox"/>	<input type="checkbox"/>

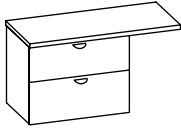

RECTANGLE RETURN
Two Lateral
Left Hand Assembly Shown

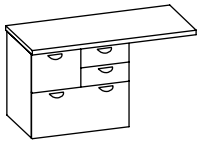

RECTANGLE RETURN
Combo
Left Hand Assembly Shown

PRODUCT NOTES

DESKS	05
ACCESSORIES	55
FINISHES	66

All Returns must be attached to a Series 50 desk, the hardware required is included.

Two File Pedestals are 15 inches wide.

Combo cabinets are 30 inches wide.

Combo shipped will be based on hand specified. Box drawers will always be oriented closest to the user.

Storage units with a box drawer ship with one pencil tray. To order additional pencil trays see page 59.

Locks

Randomly keyed locks "L" are standard on all storage units. Storage locks can be specified keyed alike "U" if required. Keyed alike option is field installed.

Modesty Panel

Modesty Panel finish matches Base Laminate.

Grain Direction

Surface grain direction can be specified front-to-back "F" or side-to-side "S". 66 and 72 inch wide Returns can only receive a side-to-side grain direction.

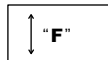

Front-to-Back

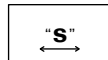

Side-to-Side

When surface grain is specified as side-to-side "S" Modesty Panel ships with horizontal grain.

When surface grain is specified as front-to-back "F" Modesty Panel ships with vertical grain.

Grommets

To add factory installed grommets place a "G" after the edge profile code above and add \$56 list for each desk.

EDGE & PULL

Edge Profile		Edge Code
	Smooth	S
	Reeded	R
	NeoClassic	E

For a closer look at edge styles, visit our website.

Pull Style	Pull Color	Pull Code
	Black	12
	Satin Chrome	13
	Black	30
	Satin Chrome	31

BRIDGE

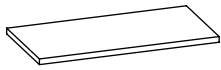

RECTANGLE BRIDGE

A / B

		PRODUCT	Modesty Panel		Surface Grain		EDGE			FINISHES		
			Yes = F No = N	Side = S Front = F	Wood Plus P	3mm W	Edge Profile <i>See Below</i>	Surface	Edge	Modesty Laminate <i>When Specified</i>		
						\$		\$				
24	30	S50BRE2430	<input type="checkbox"/>	<input type="checkbox"/>		520	636	<input type="checkbox"/>	<input type="checkbox"/>	<input type="checkbox"/>	<input type="checkbox"/>	<input type="checkbox"/>
24	36	S50BRE2436	<input type="checkbox"/>	<input type="checkbox"/>		536	652	<input type="checkbox"/>	<input type="checkbox"/>	<input type="checkbox"/>	<input type="checkbox"/>	<input type="checkbox"/>
24	42	S50BRE2442	<input type="checkbox"/>	<input type="checkbox"/>		553	668	<input type="checkbox"/>	<input type="checkbox"/>	<input type="checkbox"/>	<input type="checkbox"/>	<input type="checkbox"/>
24	48	S50BRE2448	<input type="checkbox"/>	<input type="checkbox"/>		747	862	<input type="checkbox"/>	<input type="checkbox"/>	<input type="checkbox"/>	<input type="checkbox"/>	<input type="checkbox"/>
24	54	S50BRE2454	<input type="checkbox"/>	<input type="checkbox"/>		763	878	<input type="checkbox"/>	<input type="checkbox"/>	<input type="checkbox"/>	<input type="checkbox"/>	<input type="checkbox"/>
24	60	S50BRE2460	<input type="checkbox"/>	<input type="checkbox"/>		780	896	<input type="checkbox"/>	<input type="checkbox"/>	<input type="checkbox"/>	<input type="checkbox"/>	<input type="checkbox"/>

PRODUCT NOTES

DESKS	05
ACCESSORIES	55
FINISHES	66

Bridge ships with two sets of mounting hardware.

Grommets

To add factory installed grommets place a "G" after the edge profile code above and add \$56 list for each desk.

Grain Direction

Surface grain direction can be specified front-to-back "F" or side-to-side "S". 66 and 72 inch wide Returns can only receive a side-to-side grain direction.



Front-to-Back

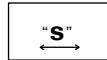

Side-to-Side

When surface grain is specified as side-to-side "S" Modesty Panel ships with horizontal grain.

When surface grain is specified as front-to-back "F" Modesty Panel ships with vertical grain.

Grommet & Modesty Location

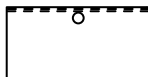

EDGE

Edge Profile		Edge Code
	Smooth	S
	Reeded	R
	NeoClassic	E

For a closer look at edge styles, visit our website.

EXTENSION

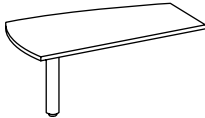
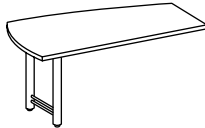
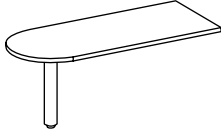
A / B	PRODUCT	Left = L Right = R	EDGE			FINISHES		
			Wood Plus	3mm	Edge Profile	Surface	Edge	Base Powder
			P	W	See Below			
			\$	\$				
 WEDGE Single Column Base Right Hand Shown	S50EWE3660S	<input type="checkbox"/>	966	1082	<input type="checkbox"/>	<input type="checkbox"/> <input type="checkbox"/>	<input type="checkbox"/> <input type="checkbox"/>	<input type="checkbox"/> <input type="checkbox"/>
	S50EWE3666S	<input type="checkbox"/>	998	1114	<input type="checkbox"/>	<input type="checkbox"/> <input type="checkbox"/>	<input type="checkbox"/> <input type="checkbox"/>	<input type="checkbox"/> <input type="checkbox"/>
	S50EWE3672S	<input type="checkbox"/>	1032	1147	<input type="checkbox"/>	<input type="checkbox"/> <input type="checkbox"/>	<input type="checkbox"/> <input type="checkbox"/>	<input type="checkbox"/> <input type="checkbox"/>
 WEDGE Double Column Base Right Hand Shown	S50EWE3660D	<input type="checkbox"/>	1169	1285	<input type="checkbox"/>	<input type="checkbox"/> <input type="checkbox"/>	<input type="checkbox"/> <input type="checkbox"/>	<input type="checkbox"/> <input type="checkbox"/>
	S50EWE3666D	<input type="checkbox"/>	1202	1317	<input type="checkbox"/>	<input type="checkbox"/> <input type="checkbox"/>	<input type="checkbox"/> <input type="checkbox"/>	<input type="checkbox"/> <input type="checkbox"/>
	S50EWE3672D	<input type="checkbox"/>	1235	1351	<input type="checkbox"/>	<input type="checkbox"/> <input type="checkbox"/>	<input type="checkbox"/> <input type="checkbox"/>	<input type="checkbox"/> <input type="checkbox"/>
 BULLET Single Column Base Right Hand Shown	S50EBU3060S	-	781	897	<input type="checkbox"/>	<input type="checkbox"/> <input type="checkbox"/>	<input type="checkbox"/> <input type="checkbox"/>	<input type="checkbox"/> <input type="checkbox"/>
	S50EBU3066S	-	809	924	<input type="checkbox"/>	<input type="checkbox"/> <input type="checkbox"/>	<input type="checkbox"/> <input type="checkbox"/>	<input type="checkbox"/> <input type="checkbox"/>
	S50EBU3072S	-	830	945	<input type="checkbox"/>	<input type="checkbox"/> <input type="checkbox"/>	<input type="checkbox"/> <input type="checkbox"/>	<input type="checkbox"/> <input type="checkbox"/>

PRODUCT NOTES

DESKS	05
ACCESSORIES	55
FINISHES	66

All Extensions must be attached to a Series 50 desk.
 Required hardware is included.



Grommets

To add factory installed grommets place a "G" after the edge profile code above and add \$56 list for each desk.

Grain Direction

Grain direction runs the length of the worksurface.

EDGE

Edge Profile		Edge Code
	Smooth	S
	Reeded	R
	NeoClassic	E

For a closer look at edge styles, visit our website.

EXTENSION

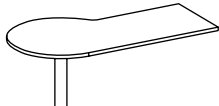
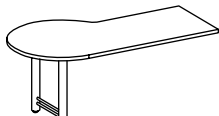
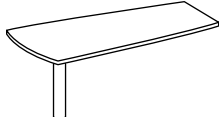
EXTENSION	A / B	PRODUCT	Left = L Right = R	EDGE			FINISHES		
				Wood Plus	3mm	Edge Profile	Surface	Edge	Base Powder
				P	W	See Below			
				\$	\$				
 <p>P-TOP Single Column Base Right Hand Shown</p>	42 66	S50EPT4266S	<input type="checkbox"/>	1277	1392	<input type="checkbox"/>	<input type="checkbox"/> <input type="checkbox"/>	<input type="checkbox"/> <input type="checkbox"/>	<input type="checkbox"/> <input type="checkbox"/>
	42 72	S50EPT4272S	<input type="checkbox"/>	1331	1447	<input type="checkbox"/>	<input type="checkbox"/> <input type="checkbox"/>	<input type="checkbox"/> <input type="checkbox"/>	<input type="checkbox"/> <input type="checkbox"/>
 <p>P-TOP Double Column Base Right Hand Shown</p>	42 66	S50EPT4266D	<input type="checkbox"/>	1480	1596	<input type="checkbox"/>	<input type="checkbox"/> <input type="checkbox"/>	<input type="checkbox"/> <input type="checkbox"/>	<input type="checkbox"/> <input type="checkbox"/>
	42 72	S50EPT4272D	<input type="checkbox"/>	1534	1650	<input type="checkbox"/>	<input type="checkbox"/> <input type="checkbox"/>	<input type="checkbox"/> <input type="checkbox"/>	<input type="checkbox"/> <input type="checkbox"/>
 <p>FAN Single Column Base Right Hand Shown</p>	36 60	S50EFA3660S	-	966	1082	<input type="checkbox"/>	<input type="checkbox"/> <input type="checkbox"/>	<input type="checkbox"/> <input type="checkbox"/>	<input type="checkbox"/> <input type="checkbox"/>
	36 66	S50EFA3666S	-	998	1114	<input type="checkbox"/>	<input type="checkbox"/> <input type="checkbox"/>	<input type="checkbox"/> <input type="checkbox"/>	<input type="checkbox"/> <input type="checkbox"/>
	36 72	S50EFA3672S	-	1032	1147	<input type="checkbox"/>	<input type="checkbox"/> <input type="checkbox"/>	<input type="checkbox"/> <input type="checkbox"/>	<input type="checkbox"/> <input type="checkbox"/>
			<input type="checkbox"/>	<input type="checkbox"/>	<input type="checkbox"/>	<input type="checkbox"/>	<input type="checkbox"/>	<input type="checkbox"/>	<input type="checkbox"/>

PRODUCT NOTES

DESKS	05
ACCESSORIES	55
FINISHES	66

All Extensions must be attached to a Series 50 desk, the hardware required is included.



Grommets

To add factory installed grommets place a "G" after the edge profile code above and add \$56 list for each desk.

Grain Direction

Grain direction runs the length of the worksurface.

EDGE

Edge Profile		Edge Code
	Smooth	S
	Reeded	R
	NeoClassic	E

For a closer look at edge styles, visit our website.

EXTENSION

A / B	PRODUCT	EDGE			FINISHES		
		Wood Plus	3mm	Edge Profile	Surface	Edge	Base Powder
		P	W	See Below			
		\$	\$				
30 72	S50ERE3072S	830	945	<input type="checkbox"/>	<input type="checkbox"/> <input type="checkbox"/>	<input type="checkbox"/> <input type="checkbox"/>	<input type="checkbox"/> <input type="checkbox"/>
36 72	S50ERE3672S	945	1061	<input type="checkbox"/>	<input type="checkbox"/> <input type="checkbox"/>	<input type="checkbox"/> <input type="checkbox"/>	<input type="checkbox"/> <input type="checkbox"/>

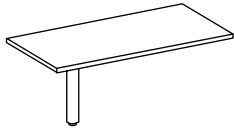

RECTANGLE
Single Column Base
Right Hand Shown

PRODUCT NOTES

DESKS	05
ACCESSORIES	55
FINISHES	66

All Extensions must be attached to a Series 50 desk, the hardware required is included.

Grommets

To add factory installed grommets place a "G" after the edge profile code above and add \$56 list for each desk.

Grain Direction

Grain direction runs the length of the worksurface.

EDGE

Edge Profile		Edge Code
	Smooth	S
	Reeded	R
	NeoClassic	E

For a closer look at edge styles, visit our website.

COMPANION TABLE

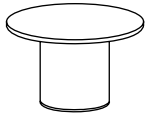

ROUND
Cylinder Base



ROUND
Cross Base

A / B

PRODUCT		EDGE			FINISHES				
		Wood Plus	3mm	Edge Profile	Surface	Edge	Base Laminate	Base Powder	
		P	W	See Below					
		\$	\$						
48	48	S50CTRD4848C	1773	1889	<input type="checkbox"/>	<input type="checkbox"/> <input type="checkbox"/>	<input type="checkbox"/> <input type="checkbox"/>	<input type="checkbox"/> <input type="checkbox"/>	-
54	54	S50CTRD5454C	2006	2121	<input type="checkbox"/>	<input type="checkbox"/> <input type="checkbox"/> <input type="checkbox"/>	<input type="checkbox"/> <input type="checkbox"/> <input type="checkbox"/>	<input type="checkbox"/> <input type="checkbox"/> <input type="checkbox"/>	-
58	58	S50CTRD5858C	2328	2443	<input type="checkbox"/>	<input type="checkbox"/> <input type="checkbox"/> <input type="checkbox"/>	<input type="checkbox"/> <input type="checkbox"/> <input type="checkbox"/>	<input type="checkbox"/> <input type="checkbox"/> <input type="checkbox"/>	-
36	36	S50CTRD3636X	1202	1317	<input type="checkbox"/>	<input type="checkbox"/> <input type="checkbox"/>	<input type="checkbox"/> <input type="checkbox"/>	-	<input type="checkbox"/> <input type="checkbox"/>
42	42	S50CTRD4242X	1359	1474	<input type="checkbox"/>	<input type="checkbox"/> <input type="checkbox"/> <input type="checkbox"/>	<input type="checkbox"/> <input type="checkbox"/> <input type="checkbox"/>	-	<input type="checkbox"/> <input type="checkbox"/> <input type="checkbox"/>
48	48	S50CTRD4848X	1438	1554	<input type="checkbox"/>	<input type="checkbox"/> <input type="checkbox"/> <input type="checkbox"/> <input type="checkbox"/>	<input type="checkbox"/> <input type="checkbox"/> <input type="checkbox"/> <input type="checkbox"/>	-	<input type="checkbox"/> <input type="checkbox"/> <input type="checkbox"/> <input type="checkbox"/>
54	54	S50CTRD5454X	1636	1751	<input type="checkbox"/>	<input type="checkbox"/> <input type="checkbox"/> <input type="checkbox"/> <input type="checkbox"/>	<input type="checkbox"/> <input type="checkbox"/> <input type="checkbox"/> <input type="checkbox"/>	-	<input type="checkbox"/> <input type="checkbox"/> <input type="checkbox"/> <input type="checkbox"/>
58	58	S50CTRD5858X	1762	1877	<input type="checkbox"/>	<input type="checkbox"/> <input type="checkbox"/> <input type="checkbox"/> <input type="checkbox"/>	<input type="checkbox"/> <input type="checkbox"/> <input type="checkbox"/> <input type="checkbox"/>	-	<input type="checkbox"/> <input type="checkbox"/> <input type="checkbox"/> <input type="checkbox"/>

PRODUCT NOTES

DESKS	05
ACCESSORIES	55
FINISHES	66

EDGE

Edge Profile		Edge Code
	Smooth	S
	Reeded	R
	NeoClassic	E

For a closer look at edge styles, visit our website.

CREDENZA



Rectangle
Surface

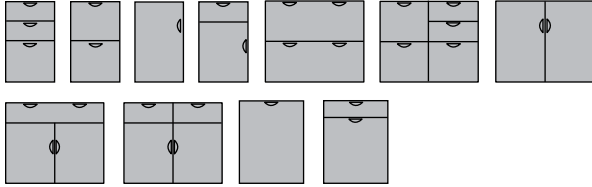

Storage Components

CREDENZA	
Surfaces	32
Storage Support Cabinets	33

SURFACE

A / B		PRODUCT	EDGE			FINISHES	
			Wood Plus	3mm	Edge Profile	Surface	Edge
			P	W	See Below		
			\$	\$			
24	15	S50TRE2415	207	323	<input type="checkbox"/>	<input type="checkbox"/>	<input type="checkbox"/>
24	21	S50TRE2421	230	346	<input type="checkbox"/>	<input type="checkbox"/>	<input type="checkbox"/>
24	24	S50TRE2424	230	346	<input type="checkbox"/>	<input type="checkbox"/>	<input type="checkbox"/>
24	30	S50TRE2430	272	387	<input type="checkbox"/>	<input type="checkbox"/>	<input type="checkbox"/>
24	36	S50TRE2436	302	417	<input type="checkbox"/>	<input type="checkbox"/>	<input type="checkbox"/>
24	42	S50TRE2442	307	422	<input type="checkbox"/>	<input type="checkbox"/>	<input type="checkbox"/>
24	45	S50TRE2445	307	422	<input type="checkbox"/>	<input type="checkbox"/>	<input type="checkbox"/>
24	48	S50TRE2448	307	422	<input type="checkbox"/>	<input type="checkbox"/>	<input type="checkbox"/>
24	54	S50TRE2454	437	553	<input type="checkbox"/>	<input type="checkbox"/>	<input type="checkbox"/>
24	60	S50TRE2460	437	553	<input type="checkbox"/>	<input type="checkbox"/>	<input type="checkbox"/>
24	63	S50TRE2463	478	593	<input type="checkbox"/>	<input type="checkbox"/>	<input type="checkbox"/>
24	66	S50TRE2466	478	593	<input type="checkbox"/>	<input type="checkbox"/>	<input type="checkbox"/>
24	72	S50TRE2472	478	593	<input type="checkbox"/>	<input type="checkbox"/>	<input type="checkbox"/>
24	75	S50TRE2475	482	598	<input type="checkbox"/>	<input type="checkbox"/>	<input type="checkbox"/>
24	78	S50TRE2478	482	598	<input type="checkbox"/>	<input type="checkbox"/>	<input type="checkbox"/>
24	84	S50TRE2484	482	598	<input type="checkbox"/>	<input type="checkbox"/>	<input type="checkbox"/>
24	90	S50TRE2490	593	709	<input type="checkbox"/>	<input type="checkbox"/>	<input type="checkbox"/>
24	96	S50TRE2496	593	709	<input type="checkbox"/>	<input type="checkbox"/>	<input type="checkbox"/>
24	102	S50TRE24102	743	859	<input type="checkbox"/>	<input type="checkbox"/>	<input type="checkbox"/>
24	108	S50TRE24108	743	859	<input type="checkbox"/>	<input type="checkbox"/>	<input type="checkbox"/>
24	114	S50TRE24114	743	859	<input type="checkbox"/>	<input type="checkbox"/>	<input type="checkbox"/>
24	120	S50TRE24120	743	859	<input type="checkbox"/>	<input type="checkbox"/>	<input type="checkbox"/>



RECTANGLE
Surface Only

PRODUCT NOTES

ACCESSORIES	55
FINISHES	66

Credenza surface does not ship with mounting hardware.

Grain Direction

Grain direction runs the length of the worksurface.

EDGE

Edge Profile		Edge Code
	Smooth	S
	Reeded	R
	NeoClassic	E

For a closer look at edge styles, see page XXX.

SUPPORT CABINET

		PRODUCT	OPTIONS	FINISHES
D / W / H	Price	Lock= L Alike= U	Pull	Case / Face
	\$			
24 15 29	993	S50SC2BF241529	<input type="checkbox"/> <input type="checkbox"/>	<input type="checkbox"/>
24 15 29	993	S50SC2F241529	<input type="checkbox"/> <input type="checkbox"/>	<input type="checkbox"/>
24 30 29	1473	S50SC2L243029	<input type="checkbox"/> <input type="checkbox"/>	<input type="checkbox"/>
24 36 29	1473	S50SC2L243629	<input type="checkbox"/> <input type="checkbox"/>	<input type="checkbox"/>



TWO BOX / FILE

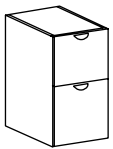

TWO FILE

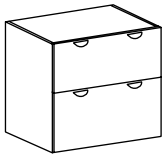

TWO LATERAL

PRODUCT NOTES

ACCESSORIES	55
FINISHES	66

All file drawers are provided with file holders configured for letter front to back and legal side to side filing.

Storage units with a box drawer ship with one pencil tray. To order additional pencil trays see page 59.

Locks

Randomly keyed locks "L" are standard on all storage units. Storage locks can be specified keyed alike "U" if required. Keyed alike option is field installed.

PULL

Pull Style	Pull Color	Pull Code
	Black	12
	Satin Chrome	13
	Black	30
	Satin Chrome	31

SUPPORT CABINET

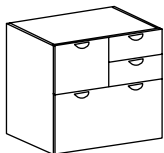

COMBO
Left Hand Shown

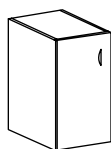

SINGLE DOOR
Left Hand Shown

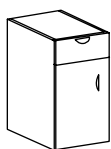

BOX / SINGLE DOOR
Left Hand Shown

D / W / H

24 30 29

24 15 29

24 21 29

24 15 36

24 21 36

24 15 29

24 21 29

24 15 36

24 21 36

PRODUCT		OPTIONS		FINISHES	
Left=L Right=R	Price	Lock=L Alike=U See Below	Pull See Below	Case / Face	
	\$				
S50SC2BFL243029	1704				
S50SCD241529	941				
S50SCD242129	941				
S50SCD241536	1034				
S50SCD242136	1034				
S50SCBD241529	993				
S50SCBD242129	1102				
S50SCBD241536	1092				
S50SCBD242136	1196				

PRODUCT NOTES

ACCESSORIES	55
FINISHES	66

All file drawers are provided with file holders configured for letter front to back and legal side to side filing.

Storage units with a box drawer ship with one pencil tray. To order additional pencil trays see page 59.

Locks

Randomly keyed locks "L" are standard on all storage units. Storage locks can be specified keyed alike "U" if required. Keyed alike option is field installed.

PULL

Pull Style	Pull Color	Pull Code
	Black	12
	Satin Chrome	13
	Black	30
	Satin Chrome	31
Touchlatch Single Door Unit Only		NN

SUPPORT CABINET

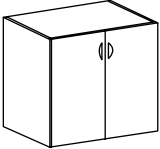
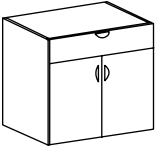
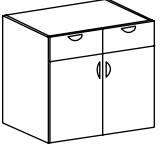
		PRODUCT	OPTIONS	FINISHES		
D / W / H		Price	Lock= L Alike= U See Below	Pull See Below	Case / Face	
		\$				
 <p>TWO DOOR</p>	24 24 29	S50SC2D242429	941	<input type="checkbox"/>	<input type="checkbox"/> <input type="checkbox"/>	<input type="checkbox"/> <input type="checkbox"/>
	24 30 29	S50SC2D243029	955	<input type="checkbox"/>	<input type="checkbox"/> <input type="checkbox"/>	<input type="checkbox"/> <input type="checkbox"/>
	24 36 29	S50SC2D243629	955	<input type="checkbox"/>	<input type="checkbox"/> <input type="checkbox"/>	<input type="checkbox"/> <input type="checkbox"/>
	24 24 36	S50SC2D242436	1034	<input type="checkbox"/>	<input type="checkbox"/> <input type="checkbox"/>	<input type="checkbox"/> <input type="checkbox"/>
	24 30 36	S50SC2D243036	1050	<input type="checkbox"/>	<input type="checkbox"/> <input type="checkbox"/>	<input type="checkbox"/> <input type="checkbox"/>
	24 36 36	S50SC2D243636	1050	<input type="checkbox"/>	<input type="checkbox"/> <input type="checkbox"/>	<input type="checkbox"/> <input type="checkbox"/>
 <p>BOX / TWO DOOR</p>	24 24 29	S50SCB2D242429	1102	<input type="checkbox"/>	<input type="checkbox"/> <input type="checkbox"/>	<input type="checkbox"/> <input type="checkbox"/>
	24 24 36	S50SCB2D242436	1196	<input type="checkbox"/>	<input type="checkbox"/> <input type="checkbox"/>	<input type="checkbox"/> <input type="checkbox"/>
 <p>TWO BOX / TWO DOOR</p>	24 30 29	S50SC2B2D243029	1278	<input type="checkbox"/>	<input type="checkbox"/> <input type="checkbox"/>	<input type="checkbox"/> <input type="checkbox"/>
	24 36 29	S50SC2B2D243629	1278	<input type="checkbox"/>	<input type="checkbox"/> <input type="checkbox"/>	<input type="checkbox"/> <input type="checkbox"/>
	24 30 36	S50SC2B2D243036	1374	<input type="checkbox"/>	<input type="checkbox"/> <input type="checkbox"/>	<input type="checkbox"/> <input type="checkbox"/>
	24 36 36	S50SC2B2D243636	1374	<input type="checkbox"/>	<input type="checkbox"/> <input type="checkbox"/>	<input type="checkbox"/> <input type="checkbox"/>

PRODUCT NOTES



ACCESSORIES	55
FINISHES	66

Storage units with a box drawer ship with one pencil tray. To order additional pencil trays see page 59.

Locks

Randomly keyed locks "L" are standard on all storage units. Storage locks can be specified keyed alike "U" if required. Keyed alike option is field installed.

PULL

Pull Style	Pull Color	Pull Code
	Black	12
	Satin Chrome	13
	Black	30
	Satin Chrome	31

Touchlatch
Two Door Unit Only **NN**

SUPPORT CABINET

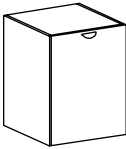
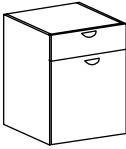
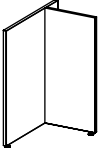
		PRODUCT	Price	Left= L Right= R	Lock= L Alike= U	Pull <i>See Below</i>	Case / Face
D / W / H			\$				
 RECYCLE BIN	24 21 29	S50SCRB242129	993	-	<input type="checkbox"/>	<input type="checkbox"/> <input type="checkbox"/>	<input type="checkbox"/> <input type="checkbox"/>
	24 24 29	S50SCRB242429	993	-	<input type="checkbox"/>	<input type="checkbox"/> <input type="checkbox"/>	<input type="checkbox"/> <input type="checkbox"/>
	24 21 36	S50SCRB242136	1092	-	<input type="checkbox"/>	<input type="checkbox"/> <input type="checkbox"/>	<input type="checkbox"/> <input type="checkbox"/>
	24 24 36	S50SCRB242436	1092	-	<input type="checkbox"/>	<input type="checkbox"/> <input type="checkbox"/>	<input type="checkbox"/> <input type="checkbox"/>
 BOX / RECYCLE BIN	24 21 29	S50SCBRB242129	1154	-	<input type="checkbox"/>	<input type="checkbox"/> <input type="checkbox"/>	<input type="checkbox"/> <input type="checkbox"/>
	24 24 29	S50SCBRB242429	1154	-	<input type="checkbox"/>	<input type="checkbox"/> <input type="checkbox"/>	<input type="checkbox"/> <input type="checkbox"/>
	24 21 36	S50SCBRB242136	1254	-	<input type="checkbox"/>	<input type="checkbox"/> <input type="checkbox"/>	<input type="checkbox"/> <input type="checkbox"/>
	24 24 36	S50SCBRB242436	1254	-	<input type="checkbox"/>	<input type="checkbox"/> <input type="checkbox"/>	<input type="checkbox"/> <input type="checkbox"/>
 END PANEL, CREDENZA		S50SEP24C	250	<input type="checkbox"/>	-	-	<input type="checkbox"/> <input type="checkbox"/>

PRODUCT NOTES



ACCESSORIES	55
FINISHES	66

Storage units with a box drawer ship with one pencil tray. To order additional pencil trays see page 59.

Locks

Randomly keyed locks "L" are standard on all storage units. Storage locks can be specified keyed alike "U" if required. Keyed alike option is field installed.

PULL

Pull Style	Pull Color	Pull Code
	Black	12
	Satin Chrome	13
	Black	30
	Satin Chrome	31

OVERHEAD STORAGE

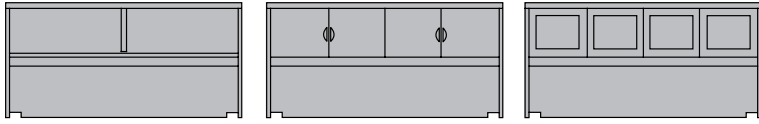

Hutch without Paper Shelf

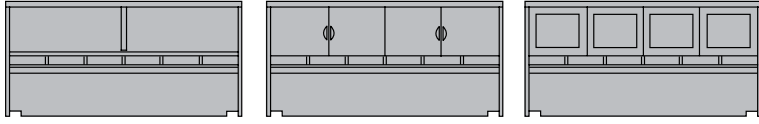

Hutch with Paper Shelf



Wall Mounted Storage

OVERHEAD STORAGE

Hutches 38

Wall Mounted Storage 43

HUTCH

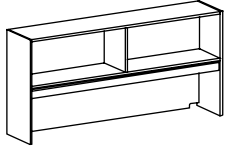

OPEN

H / W

PRODUCT		FINISHES		
	Price	Case		
	\$			
35 30	S50HOP3530N	717	<input type="checkbox"/>	<input type="checkbox"/>
35 36	S50HOP3536N	747	<input type="checkbox"/>	<input type="checkbox"/>
35 42	S50HOP3542N	760	<input type="checkbox"/>	<input type="checkbox"/>
35 48	S50HOP3548N	774	<input type="checkbox"/>	<input type="checkbox"/>
35 54	S50HOP3554N	821	<input type="checkbox"/>	<input type="checkbox"/>
35 60	S50HOP3560N	849	<input type="checkbox"/>	<input type="checkbox"/>
35 66	S50HOP3566N	870	<input type="checkbox"/>	<input type="checkbox"/>
35 72	S50HOP3572N	892	<input type="checkbox"/>	<input type="checkbox"/>
35 78	S50HOP3578N	991	<input type="checkbox"/>	<input type="checkbox"/>
35 84	S50HOP3584N	991	<input type="checkbox"/>	<input type="checkbox"/>
35 90	S50HOP3590N	1324	<input type="checkbox"/>	<input type="checkbox"/>
35 96	S50HOP3596N	1324	<input type="checkbox"/>	<input type="checkbox"/>
42 30	S50HOP4230N	730	<input type="checkbox"/>	<input type="checkbox"/>
42 36	S50HOP4236N	763	<input type="checkbox"/>	<input type="checkbox"/>
42 42	S50HOP4242N	778	<input type="checkbox"/>	<input type="checkbox"/>
42 48	S50HOP4248N	794	<input type="checkbox"/>	<input type="checkbox"/>
42 54	S50HOP4254N	864	<input type="checkbox"/>	<input type="checkbox"/>
42 60	S50HOP4260N	893	<input type="checkbox"/>	<input type="checkbox"/>
42 66	S50HOP4266N	922	<input type="checkbox"/>	<input type="checkbox"/>
42 72	S50HOP4272N	946	<input type="checkbox"/>	<input type="checkbox"/>
42 78	S50HOP4278N	1091	<input type="checkbox"/>	<input type="checkbox"/>
42 84	S50HOP4284N	1091	<input type="checkbox"/>	<input type="checkbox"/>
42 90	S50HOP4290N	1423	<input type="checkbox"/>	<input type="checkbox"/>
42 96	S50HOP4296N	1423	<input type="checkbox"/>	<input type="checkbox"/>

PRODUCT NOTES

HUTCH FABRIC PANELS	56
STORAGE ACCESSORIES	59
FINISHES	66

35 inch high Hutch aligns with 65 inch high Storage Towers. 42 inch high Hutch aligns with 72 inch high Storage Towers.

42 inch high Hutches over 72 inches long must be attached to a wall or to the back of another Hutch.

Hutches must be supported with an undersurface panel or storage directly below each end (Modesty Panel okay).

HUTCH

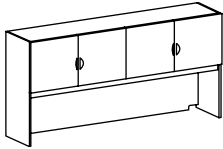
		PRODUCT	Price	Lock = L Alike = U	Pull	FINISHES
				See Below	See Below	
			\$			
	H / W					
	35 30	S50HWD3530N	955	<input type="checkbox"/>	<input type="checkbox"/>	<input type="checkbox"/>
	35 36	S50HWD3536N	995	<input type="checkbox"/>	<input type="checkbox"/>	<input type="checkbox"/>
	35 42	S50HWD3542N	1013	<input type="checkbox"/>	<input type="checkbox"/>	<input type="checkbox"/>
	35 48	S50HWD3548N	1033	<input type="checkbox"/>	<input type="checkbox"/>	<input type="checkbox"/>
	35 54	S50HWD3554N	1104	<input type="checkbox"/>	<input type="checkbox"/>	<input type="checkbox"/>
	35 60	S50HWD3560N	1132	<input type="checkbox"/>	<input type="checkbox"/>	<input type="checkbox"/>
	35 66	S50HWD3566N	1160	<input type="checkbox"/>	<input type="checkbox"/>	<input type="checkbox"/>
	35 72	S50HWD3572N	1190	<input type="checkbox"/>	<input type="checkbox"/>	<input type="checkbox"/>
	35 78	S50HWD3578N	1295	<input type="checkbox"/>	<input type="checkbox"/>	<input type="checkbox"/>
35 84	S50HWD3584N	1295	<input type="checkbox"/>	<input type="checkbox"/>	<input type="checkbox"/>	
35 90	S50HWD3590N	1776	<input type="checkbox"/>	<input type="checkbox"/>	<input type="checkbox"/>	
35 96	S50HWD3596N	1776	<input type="checkbox"/>	<input type="checkbox"/>	<input type="checkbox"/>	
42 30	S50HWD4230N	974	<input type="checkbox"/>	<input type="checkbox"/>	<input type="checkbox"/>	
42 36	S50HWD4236N	1017	<input type="checkbox"/>	<input type="checkbox"/>	<input type="checkbox"/>	
42 42	S50HWD4242N	1037	<input type="checkbox"/>	<input type="checkbox"/>	<input type="checkbox"/>	
42 48	S50HWD4248N	1058	<input type="checkbox"/>	<input type="checkbox"/>	<input type="checkbox"/>	
42 54	S50HWD4254N	1162	<input type="checkbox"/>	<input type="checkbox"/>	<input type="checkbox"/>	
42 60	S50HWD4260N	1191	<input type="checkbox"/>	<input type="checkbox"/>	<input type="checkbox"/>	
42 66	S50HWD4266N	1229	<input type="checkbox"/>	<input type="checkbox"/>	<input type="checkbox"/>	
42 72	S50HWD4272N	1262	<input type="checkbox"/>	<input type="checkbox"/>	<input type="checkbox"/>	
42 78	S50HWD4278N	1408	<input type="checkbox"/>	<input type="checkbox"/>	<input type="checkbox"/>	
42 84	S50HWD4284N	1408	<input type="checkbox"/>	<input type="checkbox"/>	<input type="checkbox"/>	
42 90	S50HWD4290N	1890	<input type="checkbox"/>	<input type="checkbox"/>	<input type="checkbox"/>	
42 96	S50HWD4296N	1890	<input type="checkbox"/>	<input type="checkbox"/>	<input type="checkbox"/>	

WOOD DOORS

PRODUCT NOTES

HUTCH FABRIC PANELS	56
STORAGE ACCESSORIES	59
FINISHES	66

35 inch high Hutch aligns with 65 inch high Storage Towers. 42 inch high Hutch aligns with 72 inch high Storage Towers.



42 inch high Hutches over 72 inches long must be attached to a wall or to the back of another Hutch.

Hutches must be supported with an undersurface panel or storage directly below each end (Modesty Panel okay).

Locks

Randomly keyed locks "L" are standard on all storage units. Storage locks can be specified keyed alike "U" if required. Keyed alike option is field installed.

PULL

Pull Style	Pull Color	Pull Code
	Black	12
	Satin Chrome	13
	Black	30
	Satin Chrome	31
	Touchlatch	NN

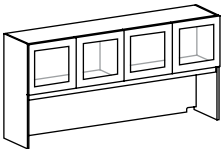
HUTCH		PRODUCT	Price	FINISHES
H / W			\$	Case / Face
 <p>GLASS DOORS</p>	35 30	S50HGD3530N	1395	<input type="checkbox"/> <input type="checkbox"/>
	35 36	S50HGD3536N	1501	<input type="checkbox"/> <input type="checkbox"/>
	35 42	S50HGD3542N	1584	<input type="checkbox"/> <input type="checkbox"/>
	35 48	S50HGD3548N	1764	<input type="checkbox"/> <input type="checkbox"/>
	35 54	S50HGD3554N	2030	<input type="checkbox"/> <input type="checkbox"/>
	35 60	S50HGD3560N	2059	<input type="checkbox"/> <input type="checkbox"/>
	35 66	S50HGD3566N	2157	<input type="checkbox"/> <input type="checkbox"/>
	35 72	S50HGD3572N	2256	<input type="checkbox"/> <input type="checkbox"/>
	35 78	S50HGD3578N	2429	<input type="checkbox"/> <input type="checkbox"/>
	35 84	S50HGD3584N	2498	<input type="checkbox"/> <input type="checkbox"/>
	35 90	S50HGD3590N	3177	<input type="checkbox"/> <input type="checkbox"/>
	35 96	S50HGD3596N	3337	<input type="checkbox"/> <input type="checkbox"/>
	42 30	S50HGD4230N	1412	<input type="checkbox"/> <input type="checkbox"/>
	42 36	S50HGD4236N	1520	<input type="checkbox"/> <input type="checkbox"/>
	42 42	S50HGD4242N	1607	<input type="checkbox"/> <input type="checkbox"/>
	42 48	S50HGD4248N	1788	<input type="checkbox"/> <input type="checkbox"/>
	42 54	S50HGD4254N	2085	<input type="checkbox"/> <input type="checkbox"/>
	42 60	S50HGD4260N	2114	<input type="checkbox"/> <input type="checkbox"/>
	42 66	S50HGD4266N	2218	<input type="checkbox"/> <input type="checkbox"/>
	42 72	S50HGD4272N	2322	<input type="checkbox"/> <input type="checkbox"/>
42 78	S50HGD4278N	2535	<input type="checkbox"/> <input type="checkbox"/>	
42 84	S50HGD4284N	2604	<input type="checkbox"/> <input type="checkbox"/>	
42 90	S50HGD4290N	3283	<input type="checkbox"/> <input type="checkbox"/>	
42 96	S50HGD4296N	3444	<input type="checkbox"/> <input type="checkbox"/>	

PRODUCT NOTES

HUTCH FABRIC PANELS	56
STORAGE ACCESSORIES	59
FINISHES	66

35 inch high Hutch aligns with 65 inch high Storage Towers. 42 inch high Hutch aligns with 72 inch high Storage Towers.

42 inch high Hutches over 72 inches long must be attached to a wall or to the back of another Hutch.

Hutches must be supported with an undersurface panel or storage directly below each end (Modesty Panel okay).

Glass doors do not receive pulls. Items ship with non-locking touchlatch.

HUTCH

PRODUCT

FINISHES

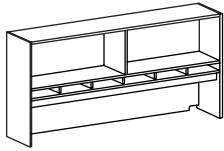

OPEN W/PAPER SHELF

H / W

42 30
42 36
42 42
42 48
42 54
42 60
42 66
42 72
42 78
42 84
42 90
42 96

S50HOP4230P
S50HOP4236P
S50HOP4242P
S50HOP4248P
S50HOP4254P
S50HOP4260P
S50HOP4266P
S50HOP4272P
S50HOP4278P
S50HOP4284P
S50HOP4290P
S50HOP4296P

Price

\$

952
985
1000
1016
1086
1115
1144
1168
1313
1313
1645
1645

Case

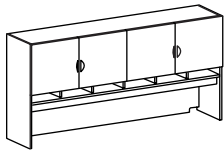

**WOOD DOORS
W/PAPER SHELF**

42 30
42 36
42 42
42 48
42 54
42 60
42 66
42 72
42 78
42 84
42 90
42 96

S50HWD4230P
S50HWD4236P
S50HWD4242P
S50HWD4248P
S50HWD4254P
S50HWD4260P
S50HWD4266P
S50HWD4272P
S50HWD4278P
S50HWD4284P
S50HWD4290P
S50HWD4296P

1196
1239
1258
1280
1384
1413
1451
1484
1630
1630
2112
2112

PRODUCT NOTES

HUTCH FABRIC PANELS	56
STORAGE ACCESSORIES	59
FINISHES	66

42 inch high Hutch aligns with 72 inch high Storage Towers.

42 inch high Hutches over 72 inches long must be attached to a wall or to the back of another Hutch.

Hutches must be supported with an undersurface panel or storage directly below each end (Modesty Panel okay).

HUTCH

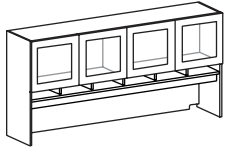

**GLASS DOORS
W/PAPER SHELF**

H / W		PRODUCT	Price	Paper Shelf	Case / Face
			\$		
42	30	S50HGD4230P	1634	<input type="checkbox"/>	<input type="checkbox"/> <input type="checkbox"/>
42	36	S50HGD4236P	1742	<input type="checkbox"/>	<input type="checkbox"/> <input type="checkbox"/>
42	42	S50HGD4242P	1829	<input type="checkbox"/>	<input type="checkbox"/> <input type="checkbox"/>
42	48	S50HGD4248P	2010	<input type="checkbox"/>	<input type="checkbox"/> <input type="checkbox"/>
42	54	S50HGD4254P	2307	<input type="checkbox"/>	<input type="checkbox"/> <input type="checkbox"/>
42	60	S50HGD4260P	2336	<input type="checkbox"/>	<input type="checkbox"/> <input type="checkbox"/>
42	66	S50HGD4266P	2440	<input type="checkbox"/>	<input type="checkbox"/> <input type="checkbox"/>
42	72	S50HGD4272P	2544	<input type="checkbox"/>	<input type="checkbox"/> <input type="checkbox"/>
42	78	S50HGD4278P	2756	<input type="checkbox"/>	<input type="checkbox"/> <input type="checkbox"/>
42	84	S50HGD4284P	2826	<input type="checkbox"/>	<input type="checkbox"/> <input type="checkbox"/>
42	90	S50HGD4290P	3505	<input type="checkbox"/>	<input type="checkbox"/> <input type="checkbox"/>
42	96	S50HGD4296P	3665	<input type="checkbox"/>	<input type="checkbox"/> <input type="checkbox"/>

*Yes=**P**
No=**N**

PRODUCT NOTES

HUTCH FABRIC PANELS	56
STORAGE ACCESSORIES	59
FINISHES	66

42 inch high Hutches over 72 inches long must be attached to a wall or to the back of another Hutch.

Hutches must be supported with an undersurface panel or storage directly below each end (Modesty Panel okay).

Glass doors do not receive pulls. Items ship with non-locking touchlatch.

WALL MOUNTED

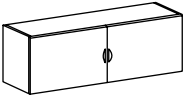
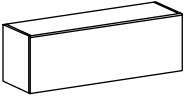
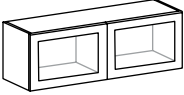
		PRODUCT	Price	Lock= L Alike= U	Pull	Case / Face
H / W				See Below	See Below	
			\$			
 <p>WOOD DOOR</p>	16 30	S50OWD30	719	<input type="checkbox"/>	<input type="checkbox"/>	<input type="checkbox"/>
	16 36	S50OWD36	781	<input type="checkbox"/>	<input type="checkbox"/>	<input type="checkbox"/>
	16 42	S50OWD42	839	<input type="checkbox"/>	<input type="checkbox"/>	<input type="checkbox"/>
	16 48	S50OWD48	875	<input type="checkbox"/>	<input type="checkbox"/>	<input type="checkbox"/>
	16 54	S50OWD54	1078	<input type="checkbox"/>	<input type="checkbox"/>	<input type="checkbox"/>
	16 60	S50OWD60	1095	<input type="checkbox"/>	<input type="checkbox"/>	<input type="checkbox"/>
 <p>FLIPPER DOOR</p>	16 30	S50OFD30	823	<input type="checkbox"/>	-	<input type="checkbox"/>
	16 36	S50OFD36	885	<input type="checkbox"/>	-	<input type="checkbox"/>
	16 42	S50OFD42	943	<input type="checkbox"/>	-	<input type="checkbox"/>
	16 48	S50OFD48	979	<input type="checkbox"/>	-	<input type="checkbox"/>
	16 54	S50OFD54	1182	<input type="checkbox"/>	-	<input type="checkbox"/>
	16 60	S50OFD60	1199	<input type="checkbox"/>	-	<input type="checkbox"/>
 <p>GLASS DOOR</p>	16 30	S50OGD30	1159	-	-	<input type="checkbox"/>
	16 36	S50OGD36	1287	-	-	<input type="checkbox"/>
	16 42	S50OGD42	1410	-	-	<input type="checkbox"/>
	16 48	S50OGD48	1606	-	-	<input type="checkbox"/>
	16 54	S50OGD54	2004	-	-	<input type="checkbox"/>
	16 60	S50OGD60	2022	-	-	<input type="checkbox"/>

PRODUCT NOTES

STORAGE ACCESSORIES	59
FINISHES	66



54 and 60 inch wide Flipper Door units have two doors.

Glass doors do not receive pulls. Items ship with non-locking touchlatch.

Locks

Randomly keyed locks "L" are standard on Wood Door and Flipper Door units. Storage locks can be specified keyed alike "U" if required. Keyed alike option is field installed.

PULL

Pull Style	Pull Color	Pull Code
	Black	12
	Satin Chrome	13
	Black	30
	Satin Chrome	31
	Touchlatch Wood Door Only	NN

NOTES

For Customer Service Inquiries, please contact:

800.426.1202

360.394.1322 *fax*

www.magnadesign.com

STORAGE TOWERS

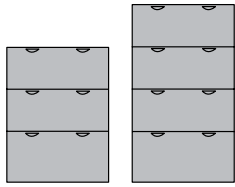

Lateral Files

STORAGE TOWERS

Lateral Files	46
Storage Towers	47
Bookcases	53

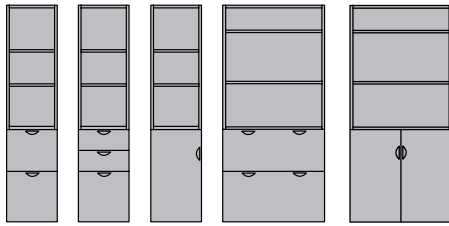

Storage Towers,
Open

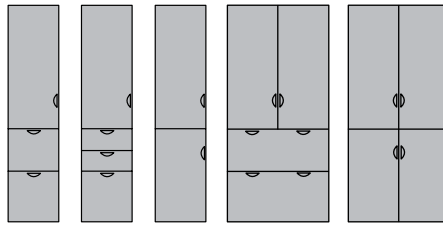

Storage Towers,
Wood Doors

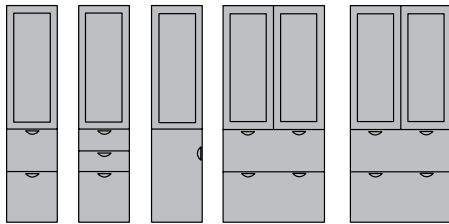

Storage Towers,
Glass Doors



Open
Bookcase

LATERALS

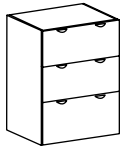

3 HIGH LATERAL

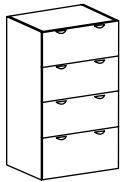

4 HIGH LATERAL

D / W / H

PRODUCT		OPTIONS	FINISHES
		Lock= L Alike= U	Pull
		See Below	See Below
		Price	Case / Face
		\$	
24 30 41	S50ST3L243041	1488	<input type="checkbox"/> <input type="checkbox"/> <input type="checkbox"/>
24 36 41	S50ST3L243641	1545	<input type="checkbox"/> <input type="checkbox"/> <input type="checkbox"/>
24 30 53	S50ST4L243053	1791	<input type="checkbox"/> <input type="checkbox"/> <input type="checkbox"/>
24 36 53	S50ST4L243653	1876	<input type="checkbox"/> <input type="checkbox"/> <input type="checkbox"/>

PRODUCT NOTES

STORAGE ACCESSORIES	59
FINISHES	66

Locks

Randomly keyed locks "L" are standard on all storage units. Storage locks can be specified keyed alike "U" if required. Keyed alike option is field installed.

PULL

Pull Style	Pull Color	Pull Code
	Black	12
	Satin Chrome	13
	Black	30
	Satin Chrome	31

STORAGE TOWER

D / W / H	PRODUCT	Left = L Right = R	EDGE		Edge Profile See Below	Lock = L Alike = U See Below	Pull See Below	FINISHES		
			Wood Plus P	3mm W				Surface	Edge	Case / Face
			\$	\$						
24 15 65	S50ST2FOP241565	-	1649	1764	<input type="checkbox"/>	<input type="checkbox"/>	<input type="checkbox"/>	<input type="checkbox"/>	<input type="checkbox"/>	<input type="checkbox"/>
24 15 72	S50ST2FOP241572	-	1691	1807	<input type="checkbox"/>	<input type="checkbox"/>	<input type="checkbox"/>	<input type="checkbox"/>	<input type="checkbox"/>	<input type="checkbox"/>
24 15 65	S50ST2BFOP241565	-	1649	1764	<input type="checkbox"/>	<input type="checkbox"/>	<input type="checkbox"/>	<input type="checkbox"/>	<input type="checkbox"/>	<input type="checkbox"/>
24 15 72	S50ST2BFOP241572	-	1691	1807	<input type="checkbox"/>	<input type="checkbox"/>	<input type="checkbox"/>	<input type="checkbox"/>	<input type="checkbox"/>	<input type="checkbox"/>
24 15 65	S50STDOP241565	<input type="checkbox"/>	1395	1510	<input type="checkbox"/>	<input type="checkbox"/>	<input type="checkbox"/>	<input type="checkbox"/>	<input type="checkbox"/>	<input type="checkbox"/>
24 15 72	S50STDOP241572	<input type="checkbox"/>	1436	1552	<input type="checkbox"/>	<input type="checkbox"/>	<input type="checkbox"/>	<input type="checkbox"/>	<input type="checkbox"/>	<input type="checkbox"/>

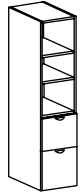

TWO FILE / OPEN

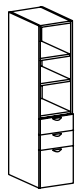

TWO BOX FILE / OPEN

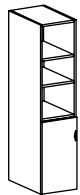

SINGLE DOOR / OPEN
Left Hand Shown

PRODUCT NOTES

STORAGE ACCESSORIES	59
FINISHES	66

Finish columns specify finishes for both the lower (storage) and upper (shelves) portion of the unit.

Storage units with a box drawer ship with one pencil tray. To order additional pencil trays see page 59.

EDGE & PULL

Locks

Randomly keyed locks "L" are standard on all storage units. Storage locks can be specified keyed alike "U" if required. Keyed alike option is field installed.

Edge Profile

Edge Code



Smooth

S



Reeded

R



NeoClassic

E

For a closer look at edge styles, visit our website.

Pull Style

Pull Color

Pull Code



Black
Satin Chrome

12
13



Black
Satin Chrome

30
31

Touchlatch
Door Units Only **NN**

STORAGE TOWER



TWO LATERAL / OPEN

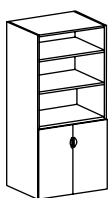

TWO DOOR / OPEN

D / W / H

PRODUCT			EDGE			OPTIONS			FINISHES		
			Wood Plus	3mm	Edge Profile	Lock=L Alike=U	Pull	Surface	Edge	Case / Face	
			P	W	See Below	See Below	See Below				
			\$	\$							
24	30	65	S50ST2LOP243065	1719	1835	<input type="checkbox"/>	<input type="checkbox"/>	<input type="checkbox"/>	<input type="checkbox"/>	<input type="checkbox"/>	
24	30	72	S50ST2LOP243072	1742	1858	<input type="checkbox"/>	<input type="checkbox"/>	<input type="checkbox"/>	<input type="checkbox"/>	<input type="checkbox"/>	
24	36	65	S50ST2LOP243665	1760	1875	<input type="checkbox"/>	<input type="checkbox"/>	<input type="checkbox"/>	<input type="checkbox"/>	<input type="checkbox"/>	
24	36	72	S50ST2LOP243672	1791	1906	<input type="checkbox"/>	<input type="checkbox"/>	<input type="checkbox"/>	<input type="checkbox"/>	<input type="checkbox"/>	
24	30	65	S50ST2DOP243065	1399	1515	<input type="checkbox"/>	<input type="checkbox"/>	<input type="checkbox"/>	<input type="checkbox"/>	<input type="checkbox"/>	
24	30	72	S50ST2DOP243072	1421	1537	<input type="checkbox"/>	<input type="checkbox"/>	<input type="checkbox"/>	<input type="checkbox"/>	<input type="checkbox"/>	
24	36	65	S50ST2DOP243665	1441	1556	<input type="checkbox"/>	<input type="checkbox"/>	<input type="checkbox"/>	<input type="checkbox"/>	<input type="checkbox"/>	
24	36	72	S50ST2DOP243672	1472	1587	<input type="checkbox"/>	<input type="checkbox"/>	<input type="checkbox"/>	<input type="checkbox"/>	<input type="checkbox"/>	

PRODUCT NOTES

STORAGE ACCESSORIES	59
FINISHES	66

Finish columns specify finishes for both the lower (storage) and upper (shelves) portion of the unit.

Two Door unit includes one adjustable shelf behind closed doors.

EDGE & PULL

Locks

Randomly keyed locks "L" are standard on all storage units. Storage locks can be specified keyed alike "U" if required. Keyed alike option is field installed.

Edge Profile

Edge Code



Smooth

S



Reeded

R



NeoClassic

E

For a closer look at edge styles, visit our website.

Pull Style

Pull Color

Pull Code



Black
Satin Chrome

12
13





Black
Satin Chrome

30
31

Touchlatch
Door Units Only

NN

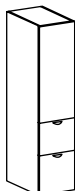
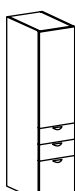
STORAGE TOWER

		PRODUCT		OPTIONS		FINISHES	
D / W / H		Left = L Right = R	Price	Lock = L Alike = U See Below	Pull See Below	Case / Face	
 <p>TWO FILE / WOOD DOOR</p>	24 15 65	S50ST2FWD241565 <input type="checkbox"/>	\$ 1649	<input type="checkbox"/>	<input type="checkbox"/>	<input type="checkbox"/>	<input type="checkbox"/>
	24 15 72	S50ST2FWD241572 <input type="checkbox"/>	1691	<input type="checkbox"/>	<input type="checkbox"/>	<input type="checkbox"/>	<input type="checkbox"/>
 <p>TWO BOX FILE / WOOD DOOR</p>	24 15 65	S50ST2BFWD241565 <input type="checkbox"/>	1649	<input type="checkbox"/>	<input type="checkbox"/>	<input type="checkbox"/>	<input type="checkbox"/>
	24 15 72	S50ST2BFWD241572 <input type="checkbox"/>	1691	<input type="checkbox"/>	<input type="checkbox"/>	<input type="checkbox"/>	<input type="checkbox"/>
 <p>WOOD DOOR Left Hand Shown</p>	24 15 65	S50STDWD241565 <input type="checkbox"/>	1395	<input type="checkbox"/>	<input type="checkbox"/>	<input type="checkbox"/>	<input type="checkbox"/>
	24 15 72	S50STDWD241572 <input type="checkbox"/>	1436	<input type="checkbox"/>	<input type="checkbox"/>	<input type="checkbox"/>	<input type="checkbox"/>

PRODUCT NOTES

STORAGE ACCESSORIES	59
FINISHES	66

Finish columns specify finishes for both the lower (storage) and upper (door) portion of the unit.

Upper doors ship standard as non-locking touch latch, unless otherwise specified.

Pull and Lock columns specify the lower (storage) portion of the unit only. To add matching locks and pulls to the top (door) portion, add a "P" to the end of the part number and add \$134 list price to each unit.

Storage units with a box drawer ship with one pencil tray. To order additional pencil trays see page 59.

Locks

Randomly keyed locks "L" are standard on all storage units. Storage locks can be specified keyed alike "U" if required. Keyed alike option is field installed.

Left or Right?

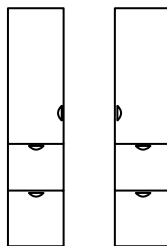

Hand is decided based on door hinge location.

If hinges are on the left, unit is left handed, if hinges are on the right, unit is right handed.



Left Right

PULL

Pull Style	Pull Color	Pull Code
	Black	12
	Satin Chrome	13
	Black	30
	Satin Chrome	31

Touchlatch
Door Units Only **NN**

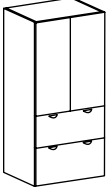
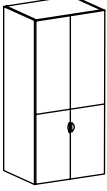
STORAGE TOWER		PRODUCT	OPTIONS	FINISHES		
D / W / H		Price	Lock= L Alike= U See Below	Pull See Below	Case / Face	
		\$				
 <p>TWO LATERAL / WOOD DOOR</p>	24 30 65	S50ST2LWD243065	1935	<input type="checkbox"/>	<input type="checkbox"/> <input type="checkbox"/>	<input type="checkbox"/> <input type="checkbox"/>
	24 30 72	S50ST2LWD243072	1959	<input type="checkbox"/>	<input type="checkbox"/> <input type="checkbox"/>	<input type="checkbox"/> <input type="checkbox"/>
	24 36 65	S50ST2LWD243665	1977	<input type="checkbox"/>	<input type="checkbox"/> <input type="checkbox"/>	<input type="checkbox"/> <input type="checkbox"/>
	24 36 72	S50ST2LWD243672	2007	<input type="checkbox"/>	<input type="checkbox"/> <input type="checkbox"/>	<input type="checkbox"/> <input type="checkbox"/>
 <p>TWO DOOR / WOOD DOOR</p>	24 30 65	S50ST2DWD243065	1616	<input type="checkbox"/>	<input type="checkbox"/> <input type="checkbox"/>	<input type="checkbox"/> <input type="checkbox"/>
	24 30 72	S50ST2DWD243072	1642	<input type="checkbox"/>	<input type="checkbox"/> <input type="checkbox"/>	<input type="checkbox"/> <input type="checkbox"/>
	24 36 65	S50ST2DWD243665	1657	<input type="checkbox"/>	<input type="checkbox"/> <input type="checkbox"/>	<input type="checkbox"/> <input type="checkbox"/>
	24 36 72	S50ST2DWD243672	1689	<input type="checkbox"/>	<input type="checkbox"/> <input type="checkbox"/>	<input type="checkbox"/> <input type="checkbox"/>

PRODUCT NOTES

STORAGE ACCESSORIES	59
FINISHES	66

Finish columns specify finishes for both the lower (storage) and upper (door) portion of the unit.

Upper doors ship standard as non-locking touch latch, unless otherwise specified.



Pull and Lock columns specify the lower (storage) portion of the unit only. To add matching locks and pulls to the top (door) portion, add a "P" to the end of the part number and add \$134 list price to each unit.

Two Door cabinet includes one adjustable shelf behind the lower doors.

Locks

Randomly keyed locks "L" are standard on all storage units. Storage locks can be specified keyed alike "U" if required. Keyed alike option is field installed.

PULL

Pull Style	Pull Color	Pull Code
	Black	12
	Satin Chrome	13
	Black	30
	Satin Chrome	31
Touchlatch Doors Units Only		NN

STORAGE TOWER

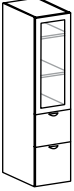
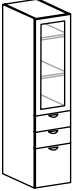
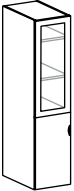
		PRODUCT		OPTIONS		FINISHES	
D / W / H		Left = L Right = R	Price	Lock = L Alike = U See Below	Pull See Below	Case / Face	
 <p>TWO FILE / GLASS DOOR</p>	24 15 65	S50ST2FGD241565 <input type="checkbox"/>	2349	<input type="checkbox"/>	<input type="checkbox"/>	<input type="checkbox"/>	<input type="checkbox"/>
	24 15 72	S50ST2FGD241572 <input type="checkbox"/>	2565	<input type="checkbox"/>	<input type="checkbox"/>	<input type="checkbox"/>	<input type="checkbox"/>
 <p>TWO BOX FILE / GLASS DOOR</p>	24 15 65	S50ST2BFGD241565 <input type="checkbox"/>	2349	<input type="checkbox"/>	<input type="checkbox"/>	<input type="checkbox"/>	<input type="checkbox"/>
	24 15 72	S50ST2BFGD241572 <input type="checkbox"/>	2565	<input type="checkbox"/>	<input type="checkbox"/>	<input type="checkbox"/>	<input type="checkbox"/>
 <p>SINGLE DOOR / GLASS DOOR <i>Left Hand Shown</i></p>	24 15 65	S50STDGD241565 <input type="checkbox"/>	2092	<input type="checkbox"/>	<input type="checkbox"/>	<input type="checkbox"/>	<input type="checkbox"/>
	24 15 72	S50STDGD241572 <input type="checkbox"/>	2310	<input type="checkbox"/>	<input type="checkbox"/>	<input type="checkbox"/>	<input type="checkbox"/>

PRODUCT NOTES

STORAGE ACCESSORIES	59
FINISHES	66

Finish columns specify finishes for both the lower (storage) and upper (shelves) portion of the unit.

Upper doors ship standard with non-locking touchlatch.

Glass doors do not receive pulls. Items ship with non-locking touchlatch.

Storage units with a box drawer ship with one pencil tray. To order additional pencil trays see page 59.

Locks



Randomly keyed locks "L" are standard on all storage units. Storage locks can be specified keyed alike "U" if required. Keyed alike option is field installed.

Left or Right?

Hand is decided based on door hinge location.

If hinges are on the left, unit is left handed, if hinges are on the right, unit is right handed.

PULL

Pull Style	Pull Color	Pull Code
	Black	12
	Satin Chrome	13
	Black	30
	Satin Chrome	31

Touchlatch
Wood Door Unit Only **NN**

STORAGE TOWER



TWO LATERAL / GLASS DOOR

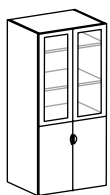

TWO DOOR / GLASS DOOR

D / W / H

24 30 65
24 30 72
24 36 65
24 36 72

PRODUCT		Price	Lock= L Alike= U	Pull	Case / Face
		\$	See Below	See Below	
S50ST2LGD243065	24 30 65	3008	<input type="checkbox"/>	<input type="checkbox"/>	<input type="checkbox"/>
S50ST2LGD243072	24 30 72	3202	<input type="checkbox"/>	<input type="checkbox"/>	<input type="checkbox"/>
S50ST2LGD243665	24 36 65	3179	<input type="checkbox"/>	<input type="checkbox"/>	<input type="checkbox"/>
S50ST2LGD243672	24 36 72	3450	<input type="checkbox"/>	<input type="checkbox"/>	<input type="checkbox"/>

24 30 65
24 30 72
24 36 65
24 36 72

S50ST2DGD243065	24 30 65	2689	<input type="checkbox"/>	<input type="checkbox"/>	<input type="checkbox"/>
S50ST2DGD243072	24 30 72	2885	<input type="checkbox"/>	<input type="checkbox"/>	<input type="checkbox"/>
S50ST2DGD243665	24 36 65	2860	<input type="checkbox"/>	<input type="checkbox"/>	<input type="checkbox"/>
S50ST2DGD243672	24 36 72	3132	<input type="checkbox"/>	<input type="checkbox"/>	<input type="checkbox"/>

PRODUCT NOTES

STORAGE ACCESSORIES	59
FINISHES	66

Finish columns specify finishes for both the lower (storage) and upper (shelves) portion of the unit.

Glass doors do not receive pulls. Items ship with non-locking touchlatch.

Locks

Randomly keyed locks "L" are standard on all storage units. Storage locks can be specified keyed alike "U" if required. Keyed alike option is field installed.

PULL

Pull Style	Pull Color	Pull Code
	Black	12
	Satin Chrome	13
	Black	30
	Satin Chrome	31

Touchlatch
Wood Door Unit Only **NN**

STORAGE TOWER

PRODUCT

FINISHES

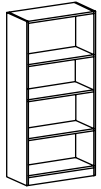

OPEN BOOKCASE

D / W / H

Price

Case /
Face

\$

15 30 29	S50BCB153029	809	<input type="checkbox"/> <input type="checkbox"/>
15 30 36	S50BCB153036	826	<input type="checkbox"/> <input type="checkbox"/>
15 30 41	S50BCB153041	892	<input type="checkbox"/> <input type="checkbox"/>
15 30 48	S50BCB153048	892	<input type="checkbox"/> <input type="checkbox"/>
15 30 53	S50BCB153053	935	<input type="checkbox"/> <input type="checkbox"/>
15 30 60	S50BCB153060	970	<input type="checkbox"/> <input type="checkbox"/>
15 30 65	S50BCB153065	970	<input type="checkbox"/> <input type="checkbox"/>
15 30 72	S50BCB153072	1018	<input type="checkbox"/> <input type="checkbox"/>
15 36 29	S50BCB153629	844	<input type="checkbox"/> <input type="checkbox"/>
15 36 36	S50BCB153636	862	<input type="checkbox"/> <input type="checkbox"/>
15 36 41	S50BCB153641	928	<input type="checkbox"/> <input type="checkbox"/>
15 36 48	S50BCB153648	928	<input type="checkbox"/> <input type="checkbox"/>
15 36 53	S50BCB153653	972	<input type="checkbox"/> <input type="checkbox"/>
15 36 60	S50BCB153660	1003	<input type="checkbox"/> <input type="checkbox"/>
15 36 65	S50BCB153665	1003	<input type="checkbox"/> <input type="checkbox"/>
15 36 72	S50BCB153672	1052	<input type="checkbox"/> <input type="checkbox"/>

PRODUCT NOTES

STORAGE ACCESSORIES

59

FINISHES

66

NOTES

For Customer Service Inquiries, please contact:

800.426.1202

360.394.1322 *fax*

www.magnadesign.com

ACCESSORIES

ACCESSORIES

Fabric Panels	56
Privacy Screens	58
Storage Accessories	59
Desk Accessories	60

ACCESSORIES



HUTCH FABRIC PANEL

H / W		PRODUCT	Price	Paper Shelf	Fabric
			\$	*Yes= P No= N	
35	30	S50FPI3530	257	N	<input type="checkbox"/> <input type="checkbox"/>
35	36	S50FPI3536	257	N	<input type="checkbox"/> <input type="checkbox"/>
35	42	S50FPI3542	257	N	<input type="checkbox"/> <input type="checkbox"/>
35	48	S50FPI3548	257	N	<input type="checkbox"/> <input type="checkbox"/>
35	54	S50FPI3554	257	N	<input type="checkbox"/> <input type="checkbox"/>
35	60	S50FPI3560	257	N	<input type="checkbox"/> <input type="checkbox"/>
35	66	S50FPI3566	294	N	<input type="checkbox"/> <input type="checkbox"/>
35	72	S50FPI3572	294	N	<input type="checkbox"/> <input type="checkbox"/>
35	78	S50FPI3578	331	N	<input type="checkbox"/> <input type="checkbox"/>
35	84	S50FPI3584	331	N	<input type="checkbox"/> <input type="checkbox"/>
35	90	S50FPI3590	331	N	<input type="checkbox"/> <input type="checkbox"/>
35	96	S50FPI3596	331	N	<input type="checkbox"/> <input type="checkbox"/>
42	30	S50FPI4230	257	<input type="checkbox"/>	<input type="checkbox"/> <input type="checkbox"/>
42	36	S50FPI4236	257	<input type="checkbox"/>	<input type="checkbox"/> <input type="checkbox"/>
42	42	S50FPI4242	257	<input type="checkbox"/>	<input type="checkbox"/> <input type="checkbox"/>
42	48	S50FPI4248	257	<input type="checkbox"/>	<input type="checkbox"/> <input type="checkbox"/>
42	54	S50FPI4254	257	<input type="checkbox"/>	<input type="checkbox"/> <input type="checkbox"/>
42	60	S50FPI4260	257	<input type="checkbox"/>	<input type="checkbox"/> <input type="checkbox"/>
42	66	S50FPI4266	294	<input type="checkbox"/>	<input type="checkbox"/> <input type="checkbox"/>
42	72	S50FPI4272	294	<input type="checkbox"/>	<input type="checkbox"/> <input type="checkbox"/>
42	78	S50FPI4278	331	<input type="checkbox"/>	<input type="checkbox"/> <input type="checkbox"/>
42	84	S50FPI4284	331	<input type="checkbox"/>	<input type="checkbox"/> <input type="checkbox"/>
42	90	S50FPI4290	331	<input type="checkbox"/>	<input type="checkbox"/> <input type="checkbox"/>
42	96	S50FPI4296	331	<input type="checkbox"/>	<input type="checkbox"/> <input type="checkbox"/>

PRODUCT NOTES

HUTCHES	37
FINISHES	66

Fabric panel dimensions represent Hutch size, they do not represent the actual size of the panel.

If Paper Shelf "P" is selected the panel size reduces 7 inches in height.

ACCESSORIES

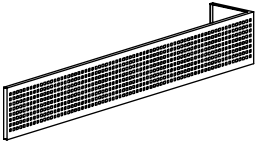
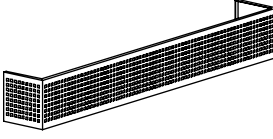
		PRODUCT	Price	FINISHES
H / W			\$	Powder
 <p>PRIVACY SCREEN "L" Layout</p>	10 60	S50PSML60	555	<input type="checkbox"/>
	10 66	S50PSML66	601	<input type="checkbox"/>
	10 72	S50PSML72	647	<input type="checkbox"/>
	10 78	S50PSML78	693	<input type="checkbox"/>
	10 84	S50PSML84	740	<input type="checkbox"/>
	10 90	S50PSML90	786	<input type="checkbox"/>
	10 96	S50PSML96	832	<input type="checkbox"/>
 <p>PRIVACY SCREEN "U" Layout</p>	10 60	S50PSMU60	647	<input type="checkbox"/>
	10 66	S50PSMU66	693	<input type="checkbox"/>
	10 72	S50PSMU72	740	<input type="checkbox"/>
	10 78	S50PSMU78	786	<input type="checkbox"/>
	10 84	S50PSMU84	717	<input type="checkbox"/>
	10 90	S50PSMU90	878	<input type="checkbox"/>
	10 96	S50PSMU96	924	<input type="checkbox"/>

PRODUCT NOTES

Screens are attached to desk with double sided tape.

The long end of an "L" layout must be attached vertically (to a hutch or wall).

Privacy Screen Applications

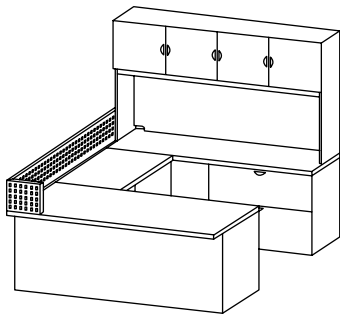

"L" Layout

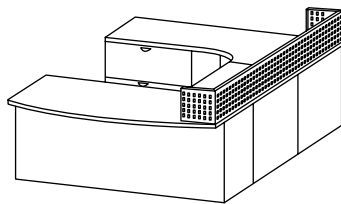

"U" Layout

STORAGE ACCESSORIES

PRODUCT

FINISHES

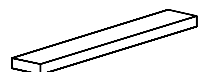

TASKLIGHT

D / W / H

7 21 2
7 27 2
7 33 2
7 39 2
7 45 2

WL24
WL30
WL36
WL42
WL48

Price

Laminate

\$

92
100
115
125
133

-
-
-
-
-

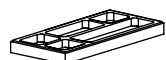

PENCIL TRAY

6 11 1

PTI

10

-

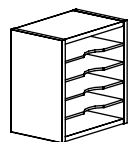

DESKTOP ORGANIZER

10 15 16
10 15 19

DTO5
DTO6

317
317



HUTCH SUPPORT PANEL

S50EP14H

174

PRODUCT NOTES

Task Light cord is 8 feet long extending from the center back of light. Task Light has built-in light diffuser.

Pencil tray includes brackets for side-to-side hanging in box drawers.

DTO5 fits below the valance of a hutch at 35 inches high, or below the valance of a hutch at 42 inches high with a paper shelf.

DTO6 fits below the valance of a hutch at 42 inches high without a paper shelf.

DESK ACCESSORIES

PRODUCT

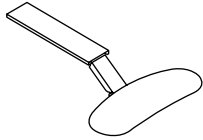

ADD-ON KEYBOARD, RETRACTABLE

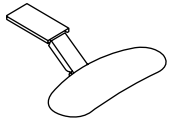

ADD-ON KEYBOARD

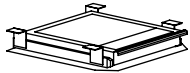

CENTER DRAWER



SPLICE PLATE



ANGLE BRACKET

	Price
DAKB	\$ 244
DAVKB	402
MGACDM21	51
MGASPO	21
MGAAB	28

PRODUCT NOTES

Add-on Keyboards are retractable along a 24 inch track. Location of the keyboard track may be impacted by obstacles beneath the worksurface and worksurface depth. Please contact customer service for details.

Splice Plate is used to connect two units of the same height.
IE: A desk extension at right angle to a shell desk.

Angle Brackets are used to connect a desk with an extension when used in a straight line.

DESK ACCESSORIES

PRODUCT



GROMMET
Set of Five

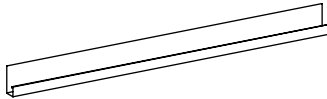

J-TRACK WIREMANAGER, MOUNTED
(attaches to Modesty Panel)

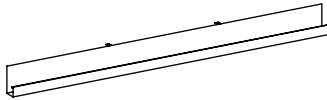

J-TRACK WIREMANAGER
(attaches to Worksurface)



WIRE MANAGER
(field adjustable)

	Price
DAGR	\$ 25
MGAMJTMP72	77
MGAMJTWS72	77
MGAWM72	43

PRODUCT NOTES

J-Track Wiremanager, Mounted attaches to a Modesty Panel.

J-Track Wiremanager mounts to a worksurface and includes brackets.

Wiremanager can be cut to length in the field and mounted underneath the worksurface.

NOTES

For Customer Service Inquiries, please contact:

800.426.1202

360.394.1322 *fax*

www.magnadesign.com

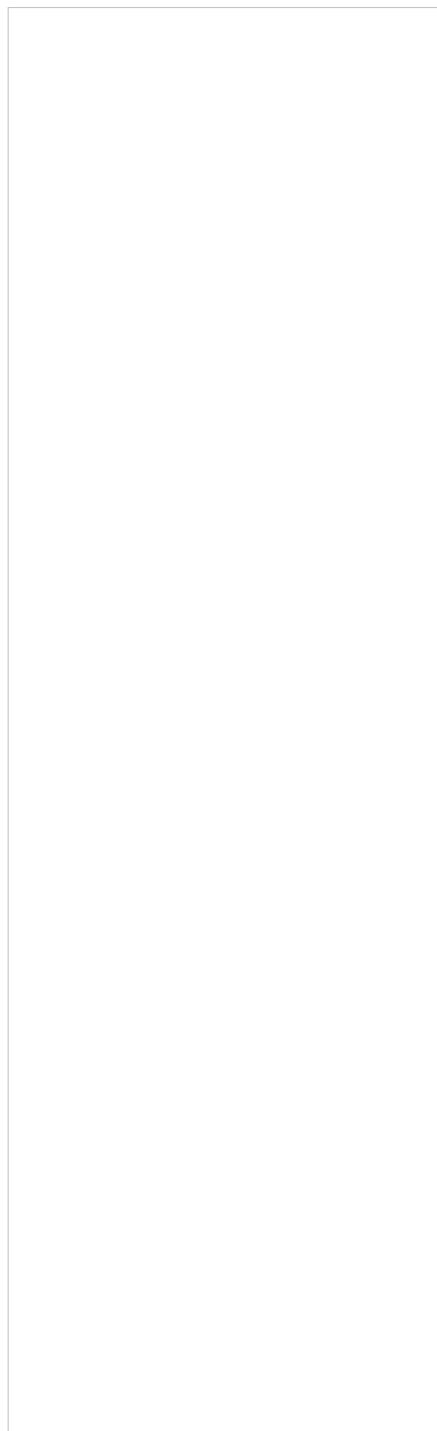
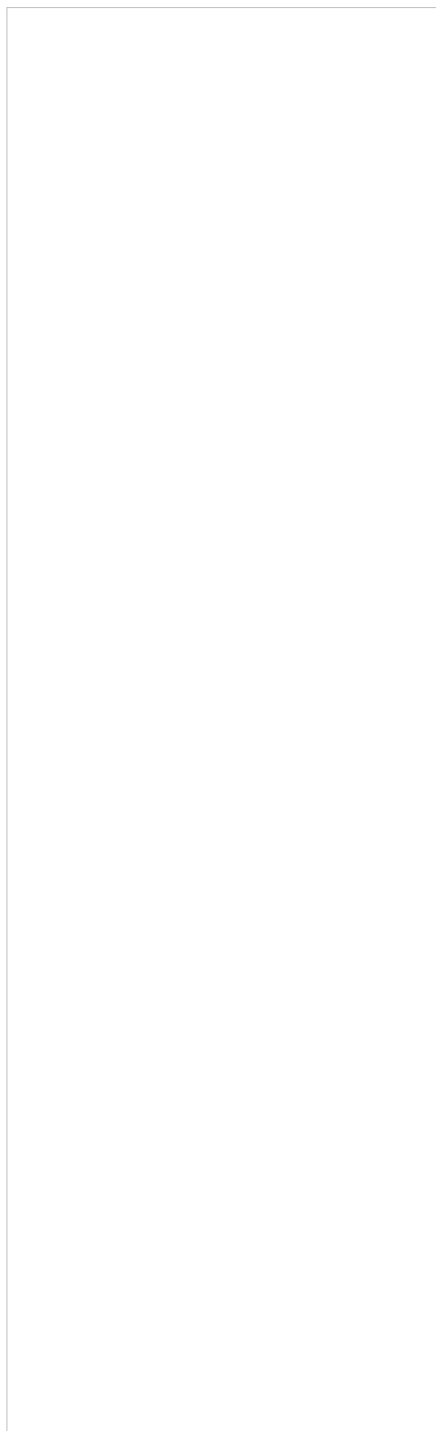
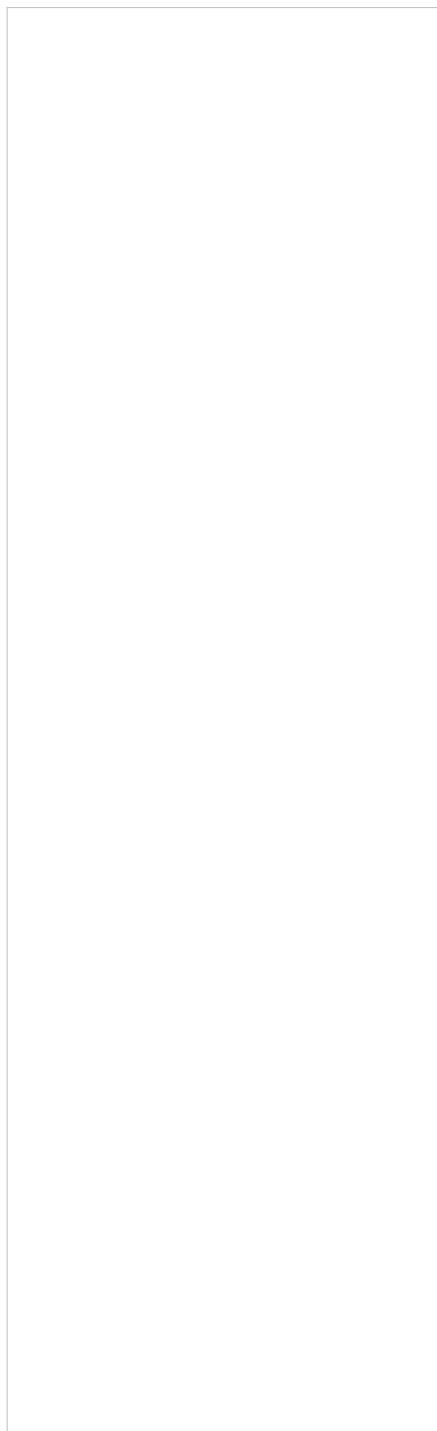

MATERIALS & SPECIFICATIONS

Series Fifty

The Series Fifty group is designed to offer a contemporary design, shipped ready to assemble, and provides a wide variety of configurations.

Worksurfaces

Worksurfaces are 1-1/2" thick and are composed of horizontal grades of plastic laminate and backing material bonded to a 1-7/16" industrial grade particleboard. Magna particleboard is recovered from Douglas Fir. The longer strands of the Douglas Fir provide superior deflection characteristics.

Edges

Woodplus:

These are synthetic edges made of 3mm thermo-fused PVC. Edges consist of a "through-grain", which shows the unique grain pattern on the trimmed edges and routed profiles. Choice of three edge profiles.

3mm:

These are solid 3mm hardwood edges. Edges are stained and finished to match worksurface and storage finish selected. Choice of three edge profiles.

Panels

All desk front, modesty and back panels are 3/4" thick, TFL construction.

Storage

Cases:

3/4" TFL case material.

Edging:

.5mm PVC edge, color and grain matched to case. All Surfaces and edges are finished.

Drawers:

Drawer bodies feature full extension 100lb (200lb for lateral files) ball bearing slides.

Leveling Glides:

Nylon based steel leveling glides with steel mounting brackets

Locks:

Locks are keyed randomly at the factory or can be keyed alike in the field.

Important Ordering Notes

A FLOOR PLAN of your Series Fifty layout is required to process your order. All hardware needed for assembly will be provided based on your floor plan.

Specifications subject to change without notice.

TERMS AND CONDITIONS

Terms of Sale

This Price List and these Terms of Sale supersede all previous price lists and terms. These prices and terms are subject to change without notice.

Prices

List prices include freight costs as specified below. No other charges are included in Magna's list prices unless otherwise specified in writing.

Terms of Payment

Terms of payment will be established based on the credit rating and credit information provided by and for specific customers. Orders are invoiced at time of shipment. Standard payment terms are 50/50; 50% due at time of order and 50% due at time of shipment. Approved credit levels may be extended to net thirty (30).

Past due accounts will be charged the lesser of 1.5% per month or the highest rate permitted by law plus all collection costs, including reasonable attorney's fees and expenses.

Taxes

The Customer shall pay all sales, use, excise and other taxes applicable to the sale. Resale and/or exemption certificates must be forwarded to Magna at the time of order.

Order Acceptance

All orders must be submitted in writing. Magna does not accept an order until the order is verified complete by a Magna Project Manager, which will include price information and anticipated arrival date. The Order Confirmation is the final expression of the contract between the Customer and Watson.

Order Changes and Cancellations

Purchase orders may not be changed or cancelled, in whole or in part, without prior written consent of Magna. Changes may effect delivery dates. Expenses incurred because of changes will be charged to Customer. In the event of cancellations, Customer will be liable for reasonable cancellation charges established by Magna. Orders for customized products, custom finishes and Customer's Own Material (COM) items, hereinafter defined, may not be cancelled.

Returns

The return of Products without a written authorization by Magna shall not be accepted. If Magna agrees to repurchase the product pursuant to a valid authorization, the Customer must return the Product freight prepaid to Magna. The returned product shall be subject to a 25% of list restocking charge. All returned Products must be unused and in original condition. Magna will not accept returns on orders that include COM materials.

Landed Freight Program

Order Minimums have been determined to help us accurately compensate for our freight expenses on low-volume orders. Minimum order and freight charge rates for all territories * have been specified below by zone.

* *Overseas and non-contiguous US shipments made to a prearranged departure port in any zone, will adhere to the defined order minimum and freight charges in that zone; carton packing charges may also apply to overseas shipments.*

ZONE 1

Alaska and Hawaii

· Customer responsible for all freight charges applied following product departure from Seattle, WA shipping dock.

ZONE 2

Continental United States and Canada

· For all orders less than \$15,000 list, a freight charge of 10% net invoice total will be applied.

Shipping

Magna employs an environmentally friendly shipping program that reduces costs and helps ensure furniture is delivered in the same condition as it left the factory. This careful handling may occasionally lengthen shipping times on LTL shipments.

Packaging

Worksurfaces and storage components are sent blanket wrapped. This process eliminates waste and reduces installation time associated with package removal and disposal.

The Customer may specify cartoning. To specify cartoning for all items, add 5% of total list price.

Air-ride

Magna utilizes carriers whose trailers are equipped with air-ride suspension to minimize vibration and avoid damage in transit.

Alternative Shipping

At Magna's discretion and if it is determined in the best interest of customers, alternative shipping methods may be used. Special requests including special shipping methods, delivery outside normal hours (8 a.m. to 5 p.m. Monday through Friday), inside delivery, notification, etc. shall be subject to an additional charge to the customer.

Claims

Risk of loss passes to Customer upon Magna's delivery of the product to the carrier. Product shortages and damage must be noted on delivery receipts at the time of receipt by the Customer or Customer's agent. If the carrier damaged the Product while in transit, the Customer has sole obligation of seeking any recourse against the appropriate carrier. Claims against Magna for shortages and errors must be made within seven (7) days of the date of delivery.

Title

Title to the Product shall remain with Magna until the Product is fully paid for.

Storage

Magna may transfer Product to storage at the Customer's risk and expense if the Customer is unable to take delivery of product as scheduled. Upon such transfer to storage, the Customer assumes risk of loss. Magna will invoice the Customer on a monthly basis for storage fees and the Customer will make payments in accordance with Magna's standard payment terms.

Loss, Damage or Delay

Magna shall not be liable for any loss, damage or delay resulting from forces beyond its reasonable control including fire, flood, strike or other labor difficulty, act of God, inability to obtain necessary labor, materials, or manufacturing facilities from usual sources, failure of suppliers to meet their contractual obligations or due to any cause beyond its reasonable control.

In the event of any such delay, delivery will be postponed by such length of time as may be reasonably necessary to compensate for the delay.

Customer's Own Material (COM)

Customers may request fabrics, surface materials, and powdercoats that are not standard to Magna's finish offering according to the guidelines below.

Magna Customer Service will apprise customers of any possible impact on lead times resulting from the use of off-card materials and finishes.

Magna shall not be responsible for the appearance or performance of any COM material and customer shall hold Magna harmless for any damages or losses arising out of, or related to, the use of the COM on the Product.

PRODUCT REPAIR OR REPLACEMENT IS THE CUSTOMER'S EXCLUSIVE REMEDY FOR ANY AND ALL PRODUCT DEFECTS.

COM orders cannot be cancelled and Magna will not accept product returns.

TERMS AND CONDITIONS (CONTINUED)

Fabric

- All COM requests for special fabric must be tested and approved by Magna.
- A minimum sample of 3 yards must be submitted to Magna for testing.
- Magna will notify customer of test results within 5 business days and provide written approval and a COM request form.
- Upon approval, customer must provide production quantities of the approved fabric at least five days before production begins.
- No price adjustments will be made for customer supplied fabric.

Laminates

- Magna must approve all COM requests for laminates not listed on finish card.
- Non-specialty laminates from WilsonArt that are not on our finish card will be available subject to a \$500 list upcharge for recycling excess materials.
- For requests concerning all other vendors and all specialty laminates, please contact Customer Service, which will determine manufacturability, schedule, and pricing.
- Evaluation of requests will take no longer than three business days.
- Magna will contact laminate vendors directly to determine availability and lead times.
- Upon approval and order acknowledgement, Magna will purchase COM laminates and arrange delivery to facilitate the production schedule.

Powder

- Customer must provide powder sample for testing.
- Upon approval, customer must provide production quantity powder three days in advance of scheduled beginning of production.
- No price adjustments will be made for customer supplied powder.

Warranty

Magna warrants that its products are free from defects in design, material, and workmanship under normal use and with proper care and maintenance. This warranty will remain in effect for the following period of time, commencing with the date of purchase from Magna but only so long as the original customer continues to own the product.

This warranty does not apply to:

- Damage caused during shipment.
- Any product installed or used other than in accordance with Magna guidelines.
- Any product that has been repaired, altered or modified by any person other than Magna.
- Any attachment added to a product.
- Any fabric or upholstery material.
- Any part or material provided by the customer.
- Any damage caused by misuse, abuse, or negligence on the part of customer or any third party.

Warranty Period

This warranty will remain in effect for the following period of time, commencing with the date of purchase from Magna but only so long as the original purchaser continues to own the product.

- All products and components not previously listed - Lifetime
- Drawer Slides - Lifetime
- Electrical components and functional mechanisms, like keyboard trays - Five Years
- Wood Finishes - Three Years

During the term of this warranty, Magna will repair or replace with the same or comparable product or part without charge any product or part that malfunctions or fails to conform to this warranty.

THIS REMEDY OF REPAIR OR REPLACEMENT IS CUSTOMER'S SOLE AND EXCLUSIVE REMEDY WITH REGARD TO ANY PRODUCT DEFECT.

THERE ARE NO OTHER WARRANTIES, EITHER EXPRESSED OR IMPLIED, INCLUDING ANY WARRANTY OF MERCHANTABILITY OR OF FITNESS FOR A PARTICULAR PURPOSE. UNDER NO CIRCUMSTANCES WILL MAGNA BE LIABLE FOR ANY CONSEQUENTIAL OR INCIDENTAL DAMAGES ARISING FROM ANY PRODUCT DEFECT.

JUNE 2010

FINISHES

Visit www.magnadesign.com/finishes for finish color representations or to order sample chips.

LAMINATES

(Surface & Storage Finish)

AI	Anigre
09	Blossom Cherry
CU	Chestnut
KP	Chocolate Pear
C7	Cognac
NQ	Espresso
FE	Fine Sycamore*
FM	Fusion Maple
G6	Golden Cherry
G7	Grove Cherry
KM	Kensington Maple
KN	Kona*
DI	Medium Cherry
JP	Mocha Cherry
F9	Sipping Seattle Java
TW	Tuscan Walnut*

*Available July 1, 2010

FABRICS*DRIFT PATTERN*

ØR	Alabaster
1H	Chamois
ØD	Dusty Miller
ØI	Graphite
3K	Mocha
9P	Pebble
4T	Slate
7U	Sprout
3J	Storm

SPRITE PATTERN

4U	Butter
2V	Harvest
7K	Khaki
4K	Kiwi
2I	Linen
4D	Powder
4B	Sherbet
7Y	Sky
2W	Snow

PVC EDGE

(Woodplus Edge Material)

AI	Anigre
BK	Black
09	Blossom Cherry
CU	Chestnut
C7	Cognac
FM	Fusion Maple
G7	Grove Cherry
KM	Kensington Maple
DI	Medium Cherry
F9	Sipping Seattle Java

WOOD EDGE

(3mm Edge Material)

AI	Anigre
BK	Black
09	Blossom Cherry
CU	Chestnut
KP	Chocolate Pear
C7	Cognac
FM	Fusion Maple
G6	Golden Cherry
G7	Grove Cherry
KM	Kensington Maple
DI	Medium Cherry
JP	Mocha Cherry
F9	Sipping Seattle Java

POWDERCOAT

BK	Black
WA	White Aluminum

THIS PAGE INTENTIONALLY LEFT BLANK

About Magna Design

Magna Design, a Watson brand, is manufactured to exacting specifications in our state-of-the-art facility located in Poulsbo, Washington. Watson is a leader in Practical Environmentalism applying low-impact manufacturing practices, waste reduction efforts, recycling programs, and a heavy reliance on recycled materials to the development of our products. For more than 40 years, Watson has proven its unwavering commitment to quality manufacturing, customer service, and responsibility - toward employees, neighbors, and the environment.

