

TIA

Spec Guide & Price List

Height-adjustable Private Office + Team + Conference



TIA SPEC GUIDE

Statement of Line.....	3
Tia Office.....	7
Tia Team + Conference.....	13
Finish Guide.....	21

ACCESSORIES PRICE LIST

Tia Office.....	22
Tia Team.....	33
Tia Conference.....	35

Prices effective April 2023

*For payment, shipping, and warranty information,
please see our [Terms & Conditions](#).*

Tia Statement of Line

Run-off Desk

*Height-adjustable with
Drawer Support Credenza*

Desk Depth: 30, 36
Desk Width: 60, 72, 84, 96
Storage Depth: 20
Storage Width: 60, 72, 84, 96
Desk Height: 28 - 47.5

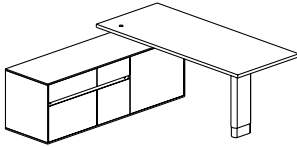

*Fixed-height with
Drawer Support Credenza*

Desk Depth: 30, 36
Desk Width: 60, 72, 84, 96
Storage Depth: 20
Storage Width: 60, 72, 84, 96
Desk Height: 29

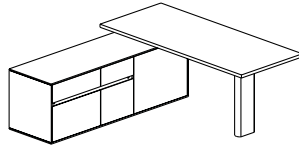

Modesty Shield

Desk Width: 60, 72, 84, 96

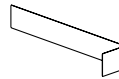

*Clamp On Monitor
Mount*



*Height-adjustable with
Combo Support Credenza*

Desk Depth: 30, 36
Desk Width: 60, 72, 84, 96
Storage Depth: 20
Storage Width: 72, 84, 96
Desk Height: 28 - 47.5

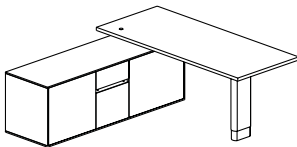

*Fixed-height with
Combo Support Credenza*

Desk Depth: 30, 36
Desk Width: 60, 72, 84, 96
Storage Depth: 20
Storage Width: 72, 84, 96
Desk Height: 29

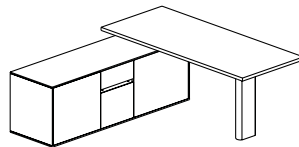

*Run Off Desk Storage
Back Panel*

Desk Width: 60, 72, 84
Desk Height: 24
Table Depth: 30, 36

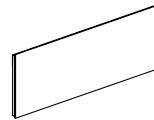

Freestanding Credenza

Drawer Storage

D: 20
W: 60, 72, 84
H: 24

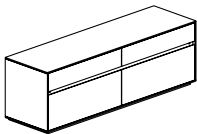

Combo Storage

D: 20
W: 60, 72, 84
H: 24

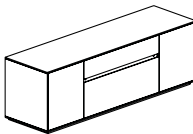

Door Storage

D: 20
W: 60, 72, 84
H: 24

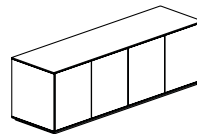

*Freestanding Storage
Back Panel*

W: 60, 72, 84
H: 24

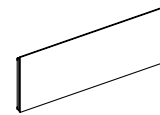

Secondary Stacking Storage

15" Door (pair)

D: 14
W: 30
H: 48, 60, 72

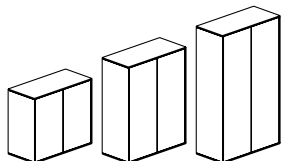

15" Open / 15" Door

D: 14
W: 30
H: 48, 60, 72

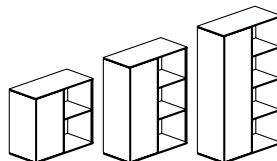

24" Open / 15" Door

D: 14
W: 39
H: 48, 60, 72

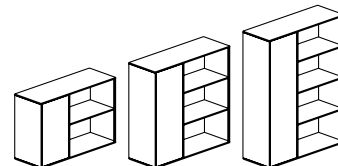

Tia Statement of Line

Secondary Storage w/ Locker

15" Locker / 15" Door

D: 14
W: 30
H: 48, 60, 72

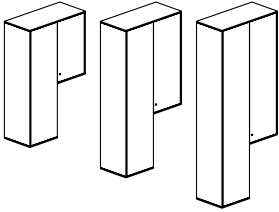

15" Open / 15" Locker

D: 14
W: 30
H: 48, 60, 72

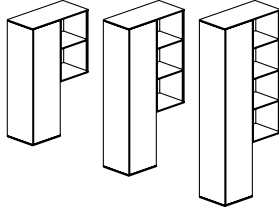

24" Open / 15" Locker

D: 14
W: 39
H: 48, 60, 72

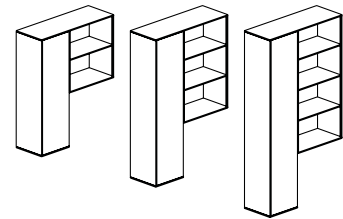

15" Open / 15" Door / 15" Locker

D: 14
W: 45
H: 48, 60, 72

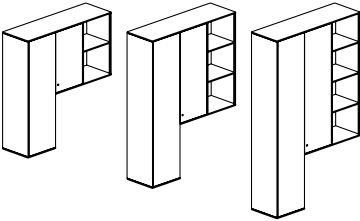

24" Open / 15" Door / 15" Locker

D: 14
W: 54
H: 48, 60, 72

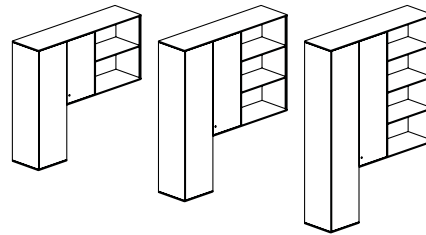

Secondary Storage w/ Wardrobe

15" Door / 24" Wardrobe

D: 14
W: 39
H: 48, 60, 72

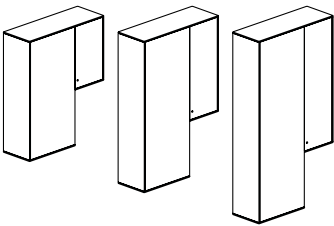

15" Open / 24" Wardrobe

D: 14
W: 39
H: 48, 60, 72

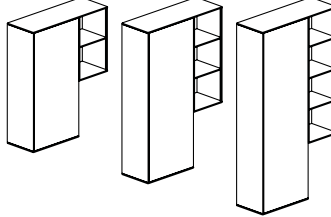

24" Open / 24" Wardrobe

D: 14
W: 48
H: 48, 60, 72

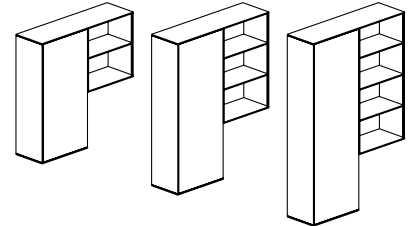

15" Open / 15" Door / 24" Wardrobe

D: 14
W: 54
H: 48, 60, 72

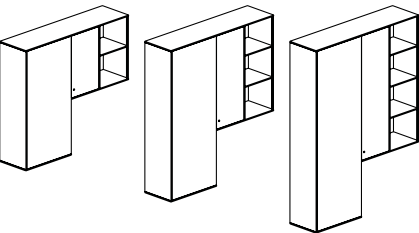

24" Open / 15" Door / 24" Wardrobe

D: 14
W: 63
H: 48, 60, 72

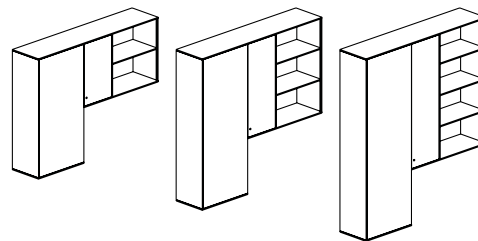

Tia Statement of Line

Team Table w/ Tech Cabinet

Rectangle, Height-adjustable

D: 48

W: 60, 72, 84, 96

H: 28 - 47.5

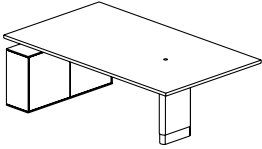

Rectangle, Fixed-height

D: 48

W: 60, 72, 84, 96

H: 29.5

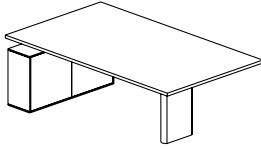

Tech Cabinet Back Panel



Monitor Mount



Super Ellipse, Height-adjustable

D: 48

W: 60, 72, 84, 96

H: 28 - 47.5

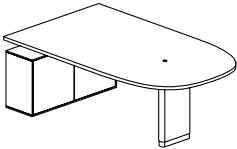

Super Ellipse, Fixed-Height

D: 48

W: 60, 72, 84, 96

H: 29.5

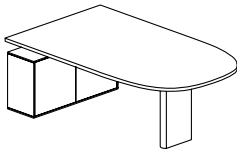

Tapered, Height-adjustable

D: 54 - 48

W: 60, 72, 84, 96

H: 28 - 47.5

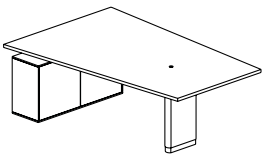

Tapered, Fixed-height

D: 54 - 48

W: 60, 72, 84, 96

H: 29.5

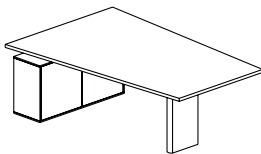

Tia Statement of Line

Conference Table

Rectangle, Height-adjustable

D: 42, 48, 54, 60

W: 84 - 144

H: 28 - 47.5

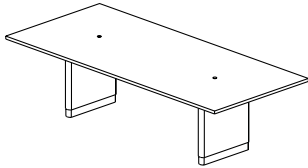

Rectangle, Fixed-height

D: 42, 48, 54, 60

W: 84 - 144

H: 29.5

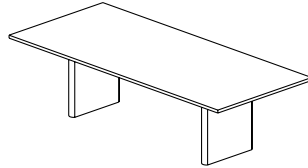

Boat, Height-adjustable

D: 60

W: 84 - 144

H: 28 - 47.5

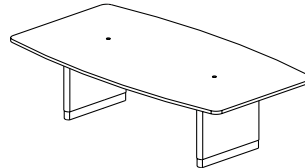

Boat, Fixed-height

D: 60

W: 84 - 144

H: 29.5

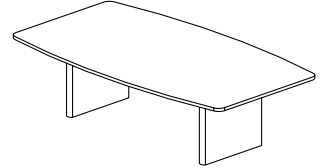

Super Ellipse, Height-adjustable

D: 48, 54, 60

W: 84 - 144

H: 28 - 47.5

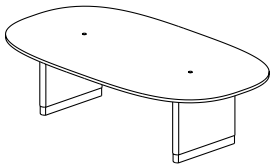

Super Ellipse, Fixed-height

D: 48, 54, 60

W: 84 - 144

H: 29.5

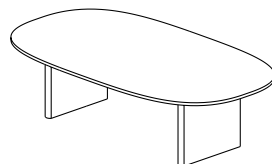

Tapered, Height-adjustable

D: 60 - 48

W: 84 - 144

H: 28 - 47.5

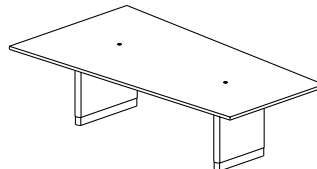

Tapered, Fixed-height

D: 60 - 48

W: 84 - 144

H: 29.5

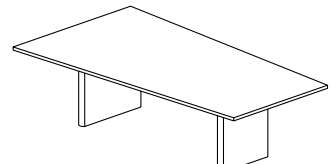

Riverstone, Height-adjustable

D: 60

W: 84 - 120

H: 28 - 47.5

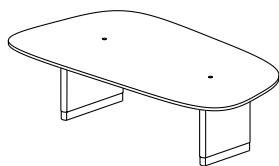

Riverstone, Fixed-height

D: 60

W: 84 - 120

H: 29.5

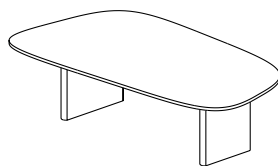

Conference Sideboard

D: 20

W: 60, 72, 84

H: 36

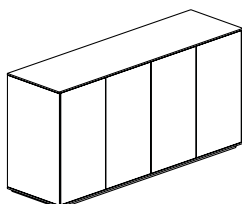

Sideboard Back Panel

W: 60, 72, 84

H: 36

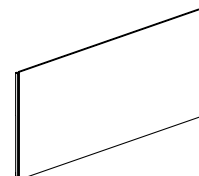

Cable Bridge

W: 84 - 144

H: 36

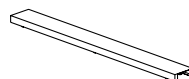

Tia Office

Edge Options



Available in all Watson laminates and Forbo finishes

Optional metal grommet located above the tech cabinet

Lifting Column adjustment range 28" - 47.5"

Fixed-height 29.5"



Optional personal power dock: 2 power + dual USB

Secondary Storage, specifiable with doors, open shelving and wardrobe



Tech Cabinet encloses lifting column and integrated cable management

Support Credenza available in box file, or drawer and door combo

Tab Pull

Tab pulls are a streamlined, timeless hardware solution and are available in black and silver.



Cove Pull

Cove pulls are integrated into the face of the drawer, reducing visual clutter for a clean look.

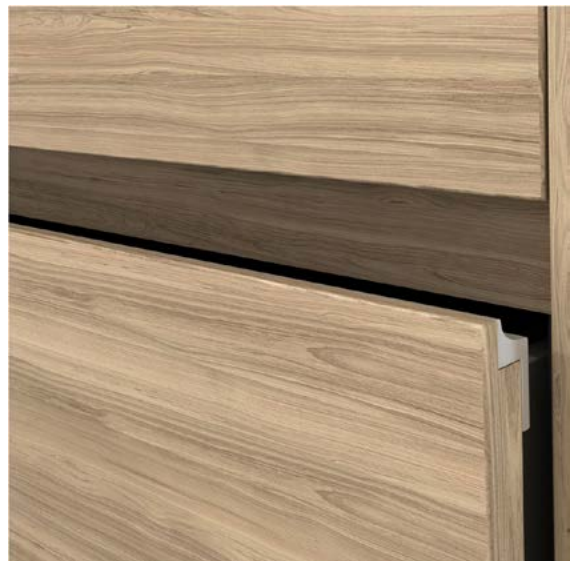

Tia Office Specifications

Run-Off Desk Size Logic

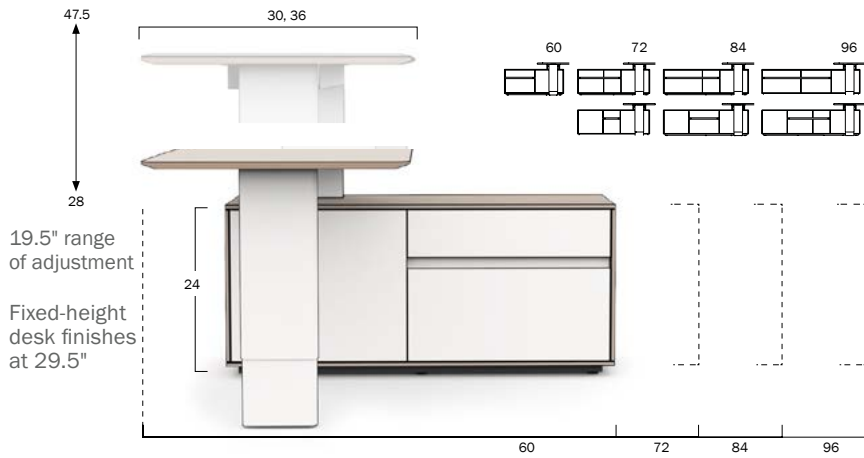

Optional Removable Back Panel



Recessed Back Storage

All credenza and secondary storage have recessed backs to allow room for plug heads and storage to sit flush against wall

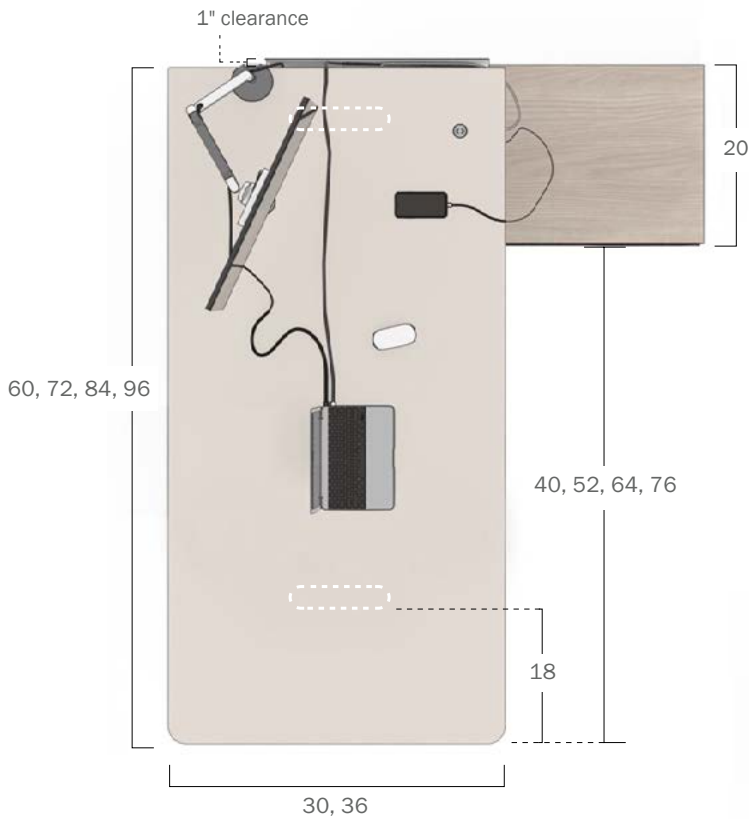

Run-Off Desk Modesty

The Tia modesty panel wraps beneath the worksurface around the outer leg. It is formed in sheet steel and can be powdercoated or covered in Forbo linoleum made from sawdust, linseed oil, and pine rosin.

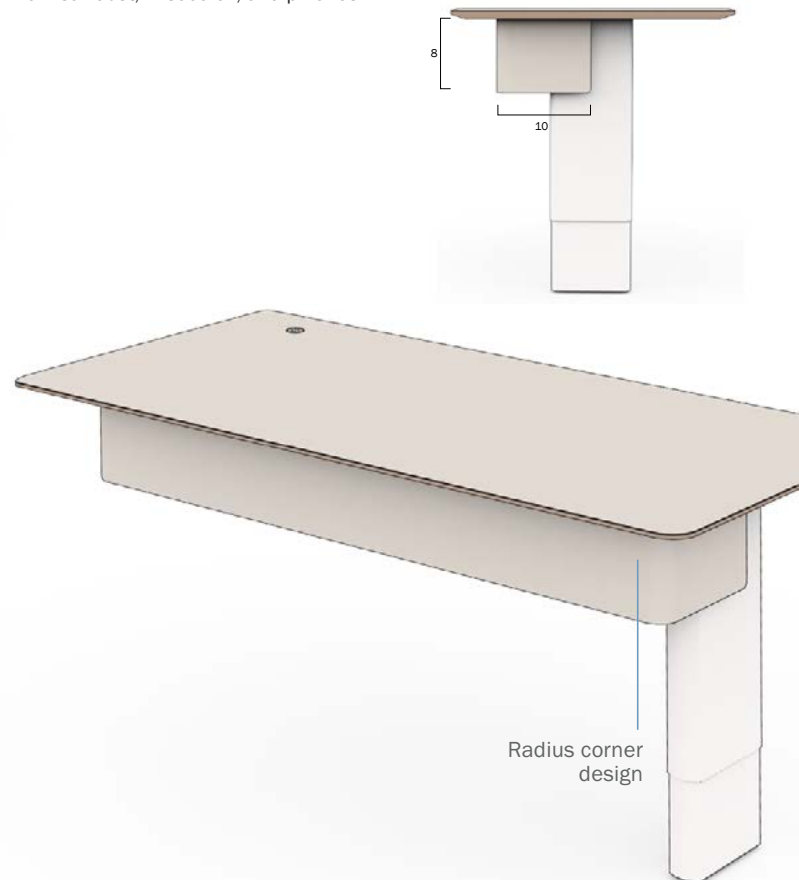

Tia Office Power & Cable Management

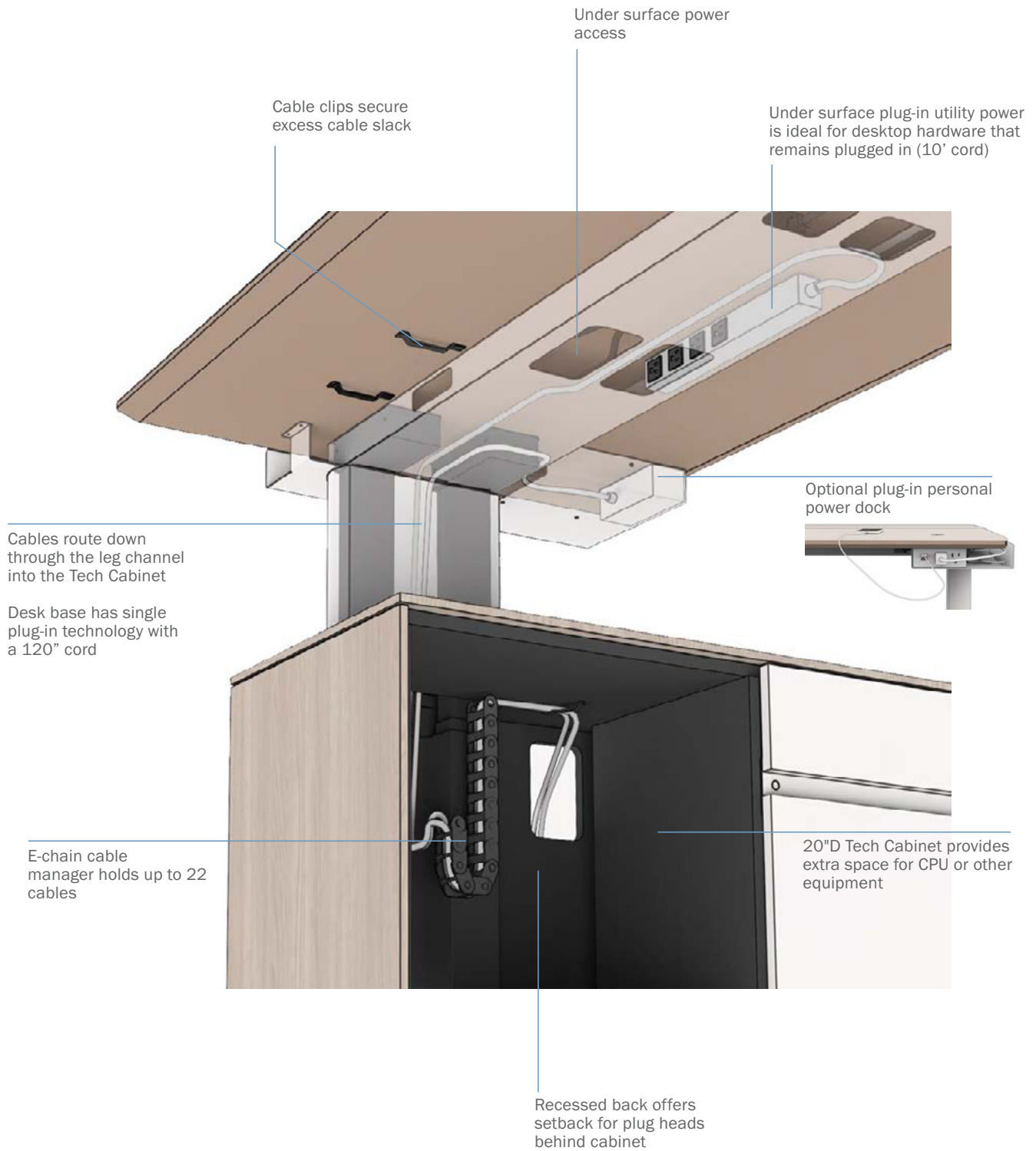

Tia Office Storage

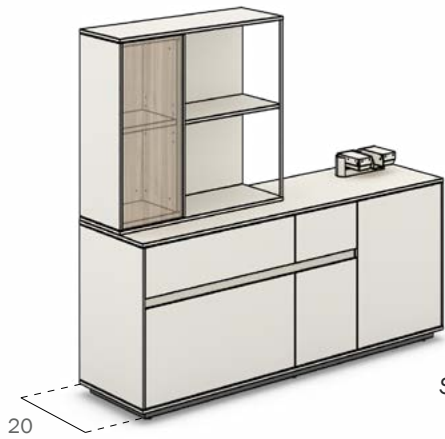

Stacker

All Tia storage sits on a black, 1-1/8" plinth base. Together with the cladding, the plinth further lightens the feel of the storage and creates a very clean aesthetic.

Tia's open shelving uses a 1/2" cladding and 1/2" steel rod support, making it sturdy despite its thin appearance.

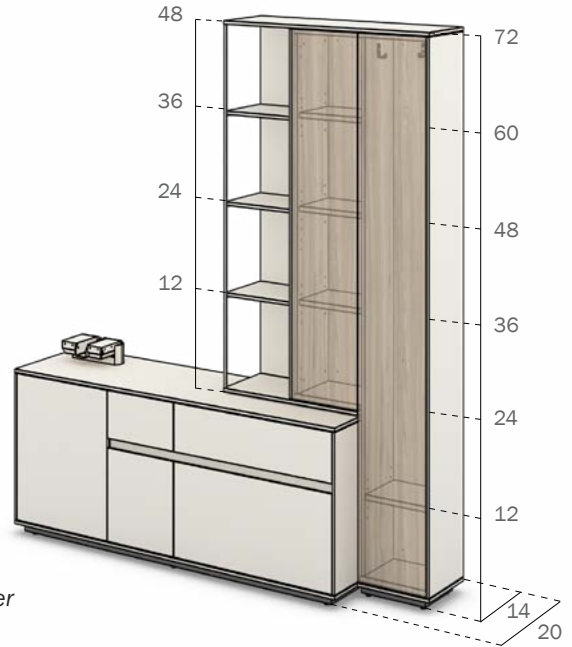

Locker

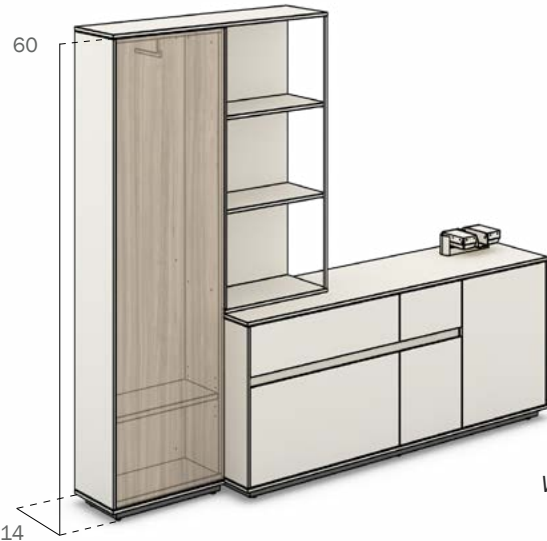

Wardrobe

Secondary storage units are bracketed to the Tia Office credenza, and come in three storage styles. Doors are available with Tab Pulls or touch-latch Cove Pulls.

Secondary Storage

Stacker

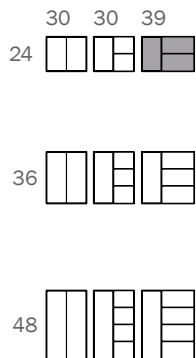

Wardrobe

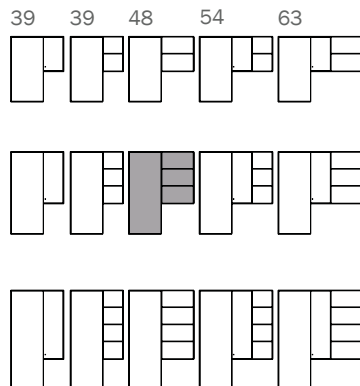

Locker

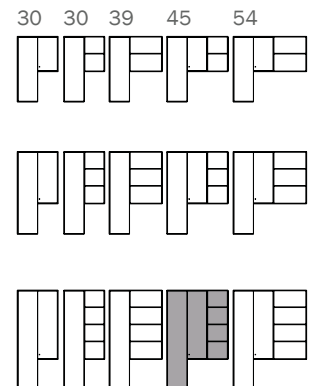

Tia Office Storage Freestanding Credenzas

Door

Dimensions ▶
Shelf dimensions ▼

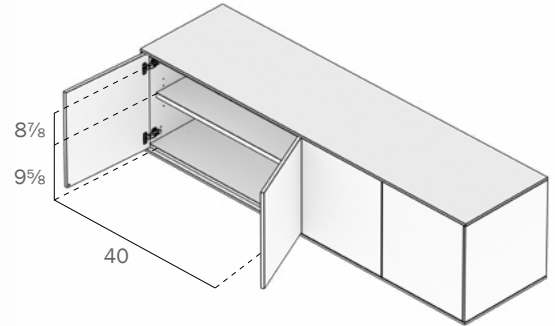
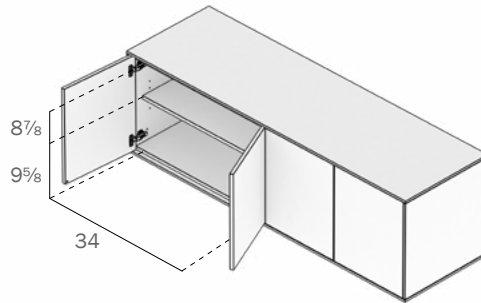
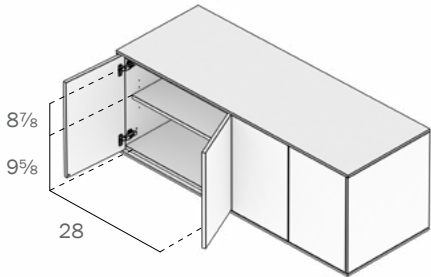
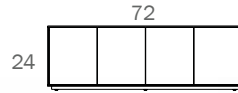
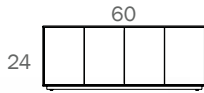

Drawer

Dimensions ▶
Filing dimensions ▼

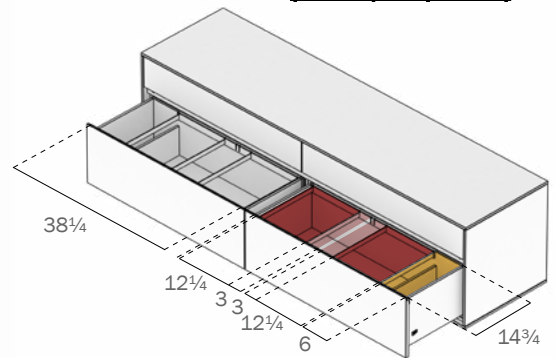
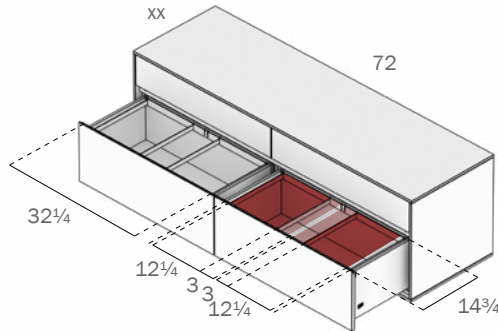
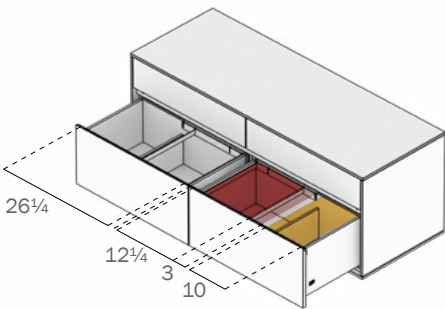
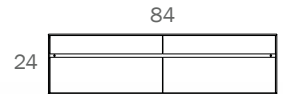
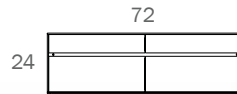
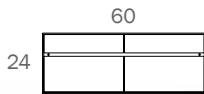

Combo

Dimensions ▶
Filing dimensions ▼

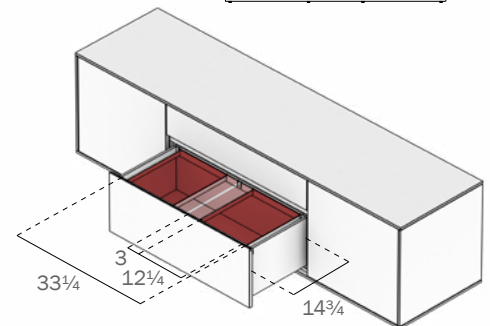
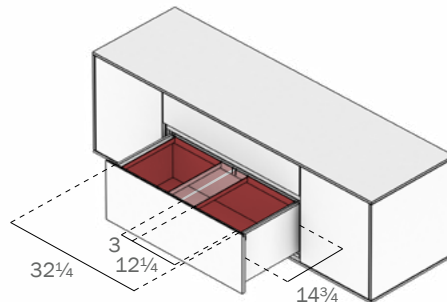
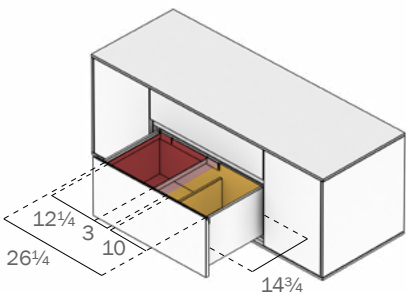
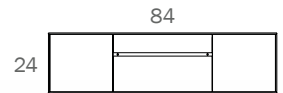
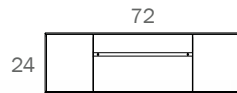
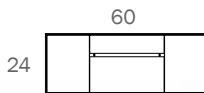

Filing Capacities in Drawered Credenzas

- Drawers under 24"W accommodate front to back letter filing
- Drawers 24" - 36"W accommodate front to back letter or legal filing
- Drawers over 36"W accommodate two rows of front to back letter or legal filing, or a combination of both letter and legal

Recessed Back Storage

All credenza and secondary storage have recessed backs to allow room for plug heads and storage to sit flush against wall

Color Key

- Front-to-back letter filing
- Expansion for legal filing
- Reserve storage space

Tia Office | Product Specification Details

Desk Storage

The Tia desk storage cabinet shell, face and internal partitions are constructed of 3/4" thick laminated industrial grade NAF particleboard finished with color matched 1.5mm polypropylene edge banding. The storage top and plinth panels are made from 1-1/8" thick laminate industrial grade NAF particleboard finished with color matched 1.5mm polypropylene edge banding. The cabinet shell and internal partitions are charcoal. The storage cladding material is 1/2" thick laminated industrial grade NAF particleboard finished with color matched 1.5mm polypropylene edge banding. The flush drawer pulls are achieved using an anodized aluminum extrusion mounted to the back side of the drawer face. All drawers are constructed from 1/2" thick laminated industrial grade NAF particleboard finished with color matched 1.5mm polypropylene and supported by undermount drawer slides with integrated soft-close mechanisms. Tab pulls are made from anodized aluminum and have subtly rounded edges and corners to prevent damage to adjacent objects. The leg clamp bracketry is made from 12-gauge cold rolled steel welded and powdered for maximum durability. The lifting mechanisms are provided by Linak and securely clamped in place to provide maximum worksurface stability. Cable management internal to the cabinet is provided by an injection molded plastic energy chain ensuring enough cable length is present in the height adjustable desk. The leg shroud is constructed from 22-gauge cold rolled steel formed with a subtle D shape.

Desk Surface

The Tia desk worksurface tops are made from either 1-1/8" M2 industrial NAF particleboard or 27mm double refined NAF MDF finished with high pressure laminate or Forbo furniture linoleum and a waterborn edge stain or 1.5mm polypropylene edge banding. The Forbo surface can have a softened waterfall edge achieved using a fused laminated NAF MDF core that is profiled and sanded prior to having the linoleum vacuum press applied. All connections are made using a robust #10-1" wood screw.

Secondary Storage

The Tia Secondary storage cabinet shell, face and internal partitions are constructed of 3/4" thick laminated industrial grade NAF particleboard finished with color matched 1.5mm polypropylene edge banding. The storage plinth panel is made from 1-1/8" thick laminate industrial grade NAF particleboard finished with color matched 1.5mm polypropylene edge banding. The cabinet shell and internal partitions are charcoal. The storage cladding material is 1/2" thick laminated industrial grade NAF particleboard finished with color matched 1.5mm polypropylene edge banding. If the unit has open display shelves these are constructed using 1/2" thick material also, the outer corner of the shelves is supported using 1/2" square hot formed steel rod. The cabinet doors are either supplied with an anodized aluminum pull or touch release door hardware. The units are designed to integrate with other Tia storage units and come with 12-gauge powder coated cold rolled steel mounting bracket required for stability.

Freestanding Storage

The Tia freestanding storage cabinet shell, face and internal partitions are constructed of 3/4" thick laminated industrial grade NAF particleboard finished with color matched 1.5mm polypropylene edge banding. The storage top and plinth panels are made from 1-1/8" thick laminate industrial grade NAF particleboard finished with color matched 1.5mm polypropylene edge banding. The cabinet shell and internal partitions are charcoal. The storage cladding material is 1/2" thick laminated industrial grade NAF particleboard finished with color matched 1.5mm polypropylene edge banding. The flush drawer pulls are achieved using an anodized aluminum extrusion mounted to the back side of the drawer face. All drawers are constructed from 1/2" thick laminated industrial grade NAF particleboard finished with color matched 1.5mm polypropylene and supported by undermount drawer slides with integrated soft-close mechanisms. Tab pulls are made from anodized aluminum and have subtly rounded edges and corners to prevent damage to adjacent objects.

Tia Team Tables

Edge Options



Team Power & Cable Management

Integrated cable channel routes monitor cables down through leg

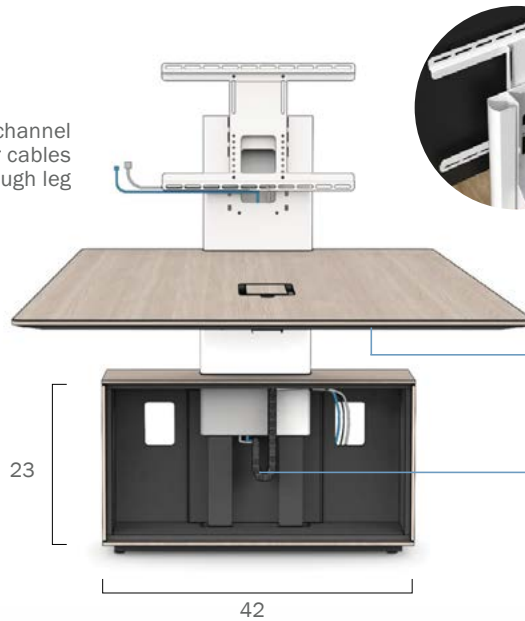

Universal monitor mount clamps to tables .75" - 1.25" thick



Under surface utility power and cable management accessible from beneath the surface

Cables for lifting columns and power/data are routed through a high capacity E-chain in the Tech Cabinet



Tia in-surface power features a unique hinged lid for dual-sided access with three choices of power configurations

Single-piece top available in all Watson laminates and Forbo finishes

Monitor Mount supports monitors up to 55" and up to 60 lbs.

Embedded control switch flush-mounted in table surface in clear aluminum finish

Lifting column constructed using a precision-formed steel shroud. Adjustment range from 28" to 47.5"

Fixed height 29.5"

User accessible utility power below the table surface

Cables are routed out the back of the Tech Cabinet to wall power. Cabinet backs are recessed so they can sit flush against the wall.

Tia Team Tables Specifications

Team Size Logic

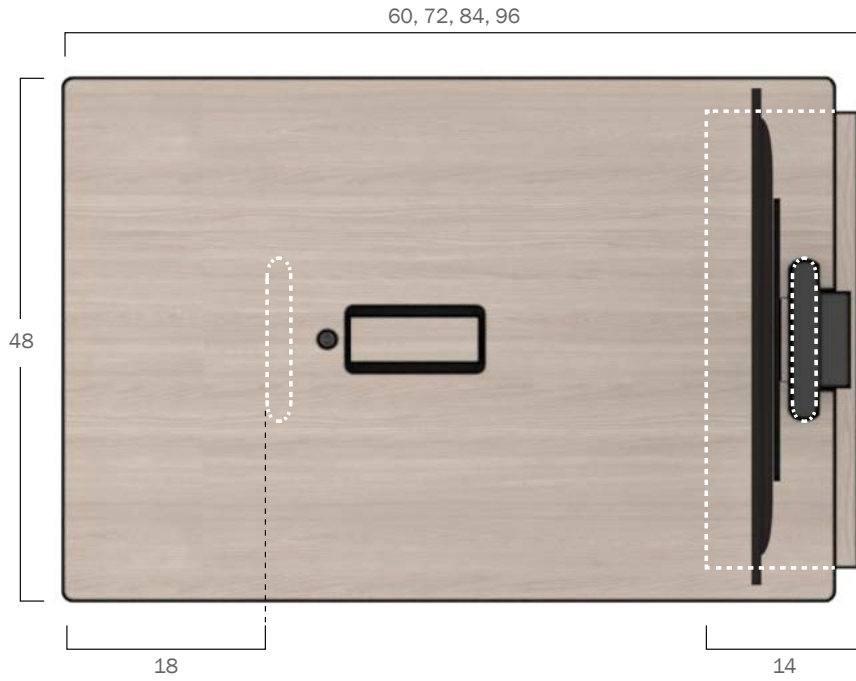
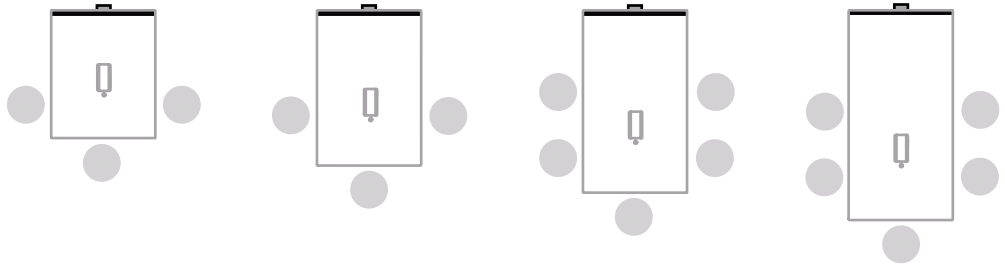
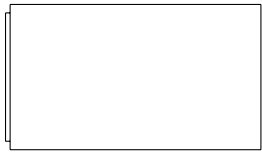

Table Top Options

Rectangle

D: 48
W: 60, 72, 84, 96



Super Ellipse

D: 48
W: 60, 72, 84, 96

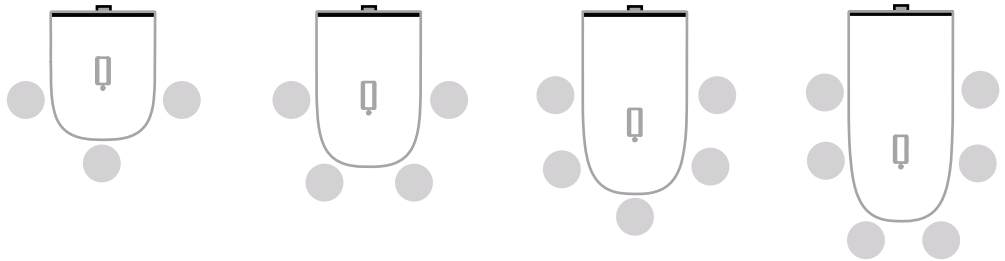
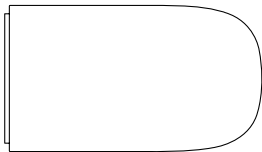

Tapered

D: 54 - 48
W: 60, 72, 84, 96

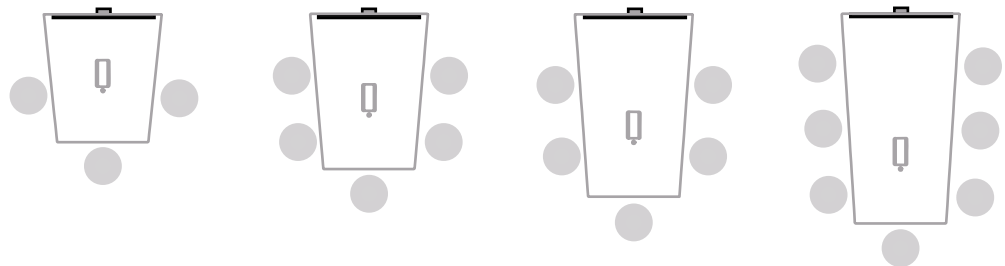
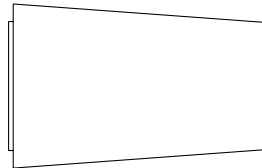

Tia Conference Tables

Edge Options

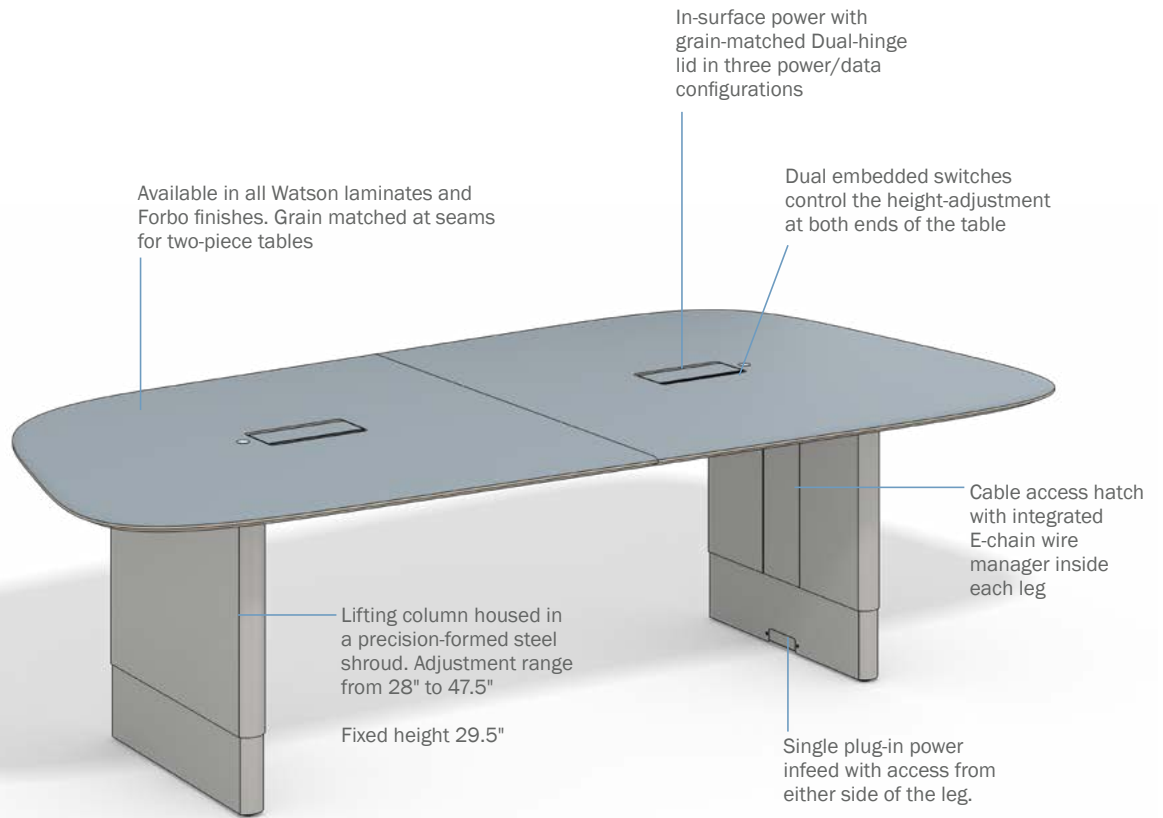

Power Switch

The height-adjustment is controlled through a flush mounted switch embedded in the surface. This is typical for all Tia surfaces.



Tia Conference Tables

Table Top Options

Rectangle

D: 42, 48, 54, 60

W: 84 - 144

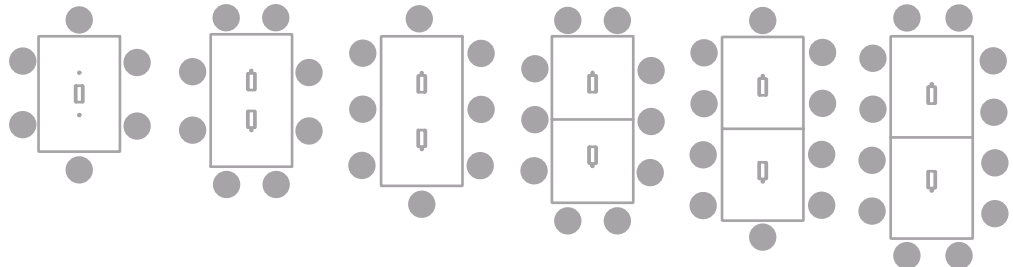

Boat

D: 60

W: 84 - 144

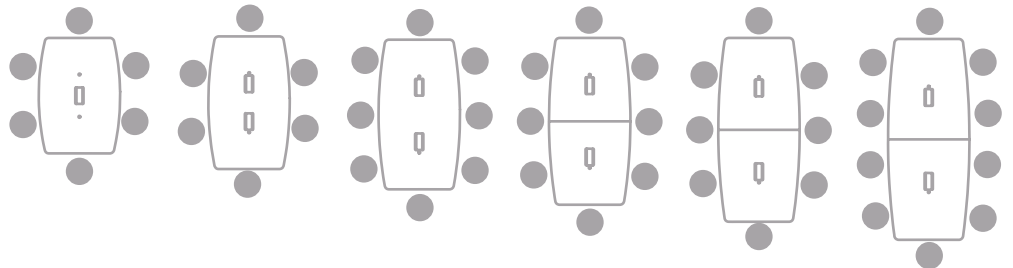
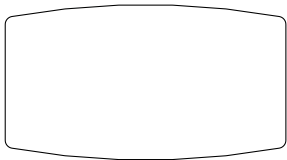

Super Ellipse

D: 48, 54, 60

W: 84 - 144

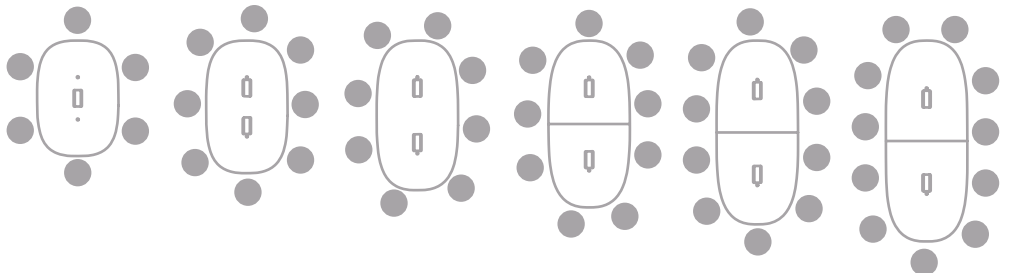
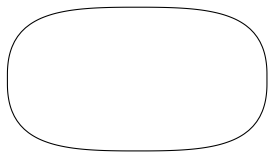

Tapered

D: 60 - 48

W: 84 - 144

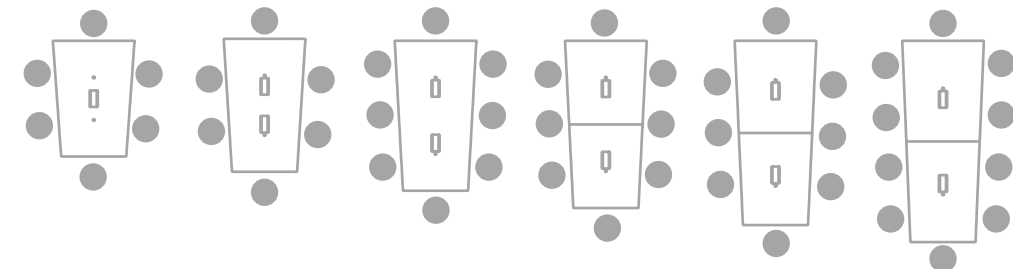
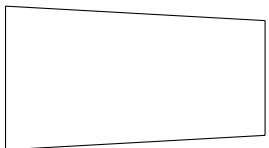

Riverstone

D: 60

W: 84 - 120

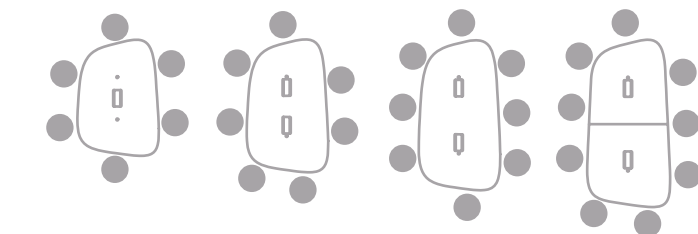
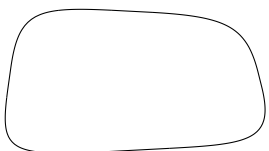

*Showing 60" table depths

Tia Conference Cable Management



Cables for lifting columns and power/data are routed through a high capacity E-chain in each column. Removable access hatch on inside of each column

Single plug-in technology. Infeed access from either side of the leg. Discrete adjustable glides under each lifting column



Optional Cable Bridge

Steel Cable Bridge facilitates concealed wire management from the floor core to either leg.

84 - 144W

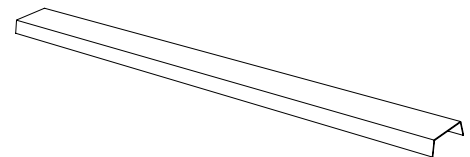

Tia Team & Conference Power Options

In-Surface Power

The Dual-hinge power unit is Watson's unique two-way access to Tia in-surface power/data. Lids are grain-matched to the worksurface and house ample space beneath for excess cables.



Available in the following three power/data configurations:

Dual-hinge Full

- 3 Power
- 2 USB
- 1 HDMI
- 1 CAT6E

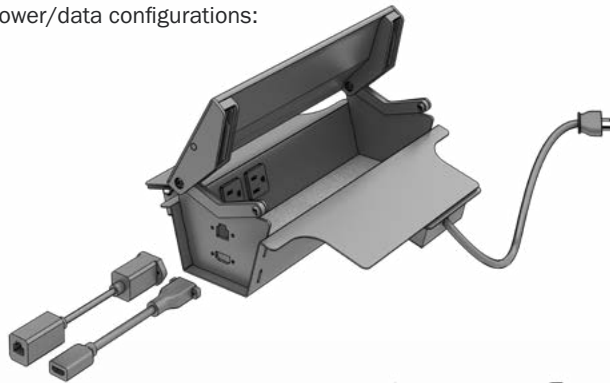

Power Locations

Tia Team



Centered in-surface power with optional grommet

Dual-hinge Basic

- Commercial 4 power plug strip
- 1 HDMI
- 1 CAT6E
- 10' Cord

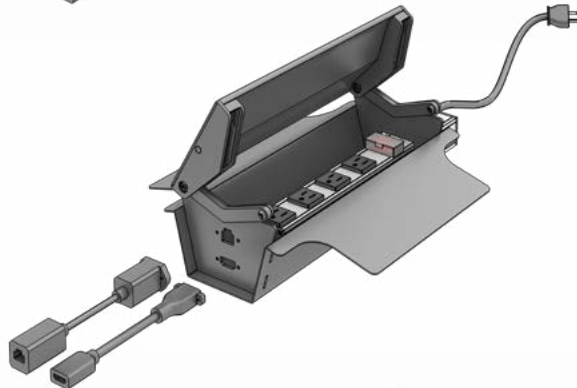

Tia Conference



Centered in-surface power



Centered in-surface power with optional grommet at end 1 and/or end 2

Dual-hinge Open (no power)

- 1 HDMI
- 1 CAT6E

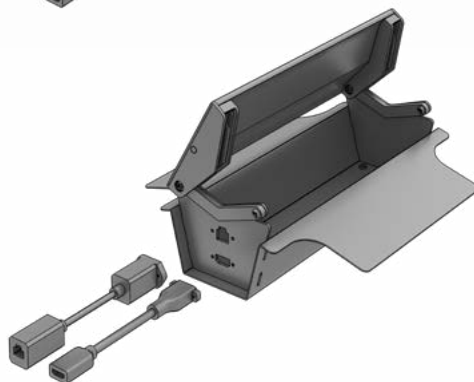

Dual in-surface power with optional center grommet

Tia Conference Sideboard

The Tia Sideboard Credenza is counter-height which makes it ideal for hospitality uses in the conference room. Doors provide ample room for storing service wear, binders, or technology. Available with Tab Pulls or touch-latch Cove Pulls.

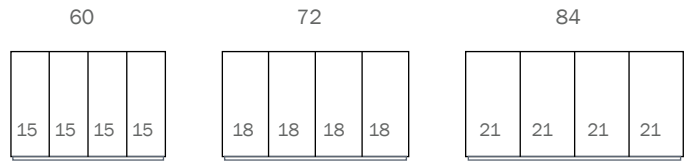

Tia Team & Conference Tables | Product Specification Details

Team Table Storage

The Team table storage cabinet shell, face and internal partitions are constructed of 3/4" thick laminated industrial grade NAF particleboard finished with color matched 1.5mm polypropylene edge banding. The storage top and plinth panels are made from 1-1/8" thick laminate industrial grade NAF particleboard finished with color matched 1.5mm polypropylene edge banding. The cabinet shell and internal partitions are charcoal. The storage cladding material is 1/2" thick laminated industrial grade NAF particleboard finished with color matched 1.5mm polypropylene edge banding. The flush doors are operable using touch release hardware. Tab pulls are made from anodized aluminum and have subtly rounded edges and corners to prevent damage to adjacent objects. The leg clamp bracketry is made from 12-gauge cold rolled steel welded and powdered for maximum durability. The lifting mechanisms are provided by Linak and securely clamped in place to provide maximum worksurface stability. Cable management internal to the cabinet is provided by an injection molded plastic energy chain ensuring enough cable length is present in the height adjustable desk. The leg shroud is constructed from 22-gauge cold rolled steel formed with a subtle D shape.

Team/Conference Table Surfaces

The Tia team and conference worksurfaces tops are made from either 1-1/8" M2 industrial NAF particleboard or 27mm double refined NAF MDF finished with high pressure laminate or Forbo furniture linoleum. The Forbo surface can have a softened waterfall edge achieved using a fused laminated NAF MDF core that is profiled and sanded prior to having the linoleum vacuum press applied. All connections are made using a robust #10-1" wood screw. User accessible power is available as an optional add on, access is provided via a dual-action aluminum extrusion and injection molded component assembly that can rotate open from two sides. The power trough contains 3-outlets and dual charging USB, there are additional knockouts for HDMI and network connections.

Tia Table Legs

The Tia table legs are constructed from two discrete oval shrouds each constructed of two pieces of formed 22-gauge cold rolled steel that are welded together using a continuous linear TIG welding machine and finally ground flush to have a complexly seamless appearance. The shrouds are kept from scratching each other during table operation using a super simple felt guiding system. The base of each leg is a 1/4" thick laser cut hot rolled steel piece. The tops of the electric adjustable legs are held securely using a 12-gauge bracket. All metal components are powder coated to individually match customer expectation.

AV Mount

The AV mount is constructed from cold rolled steel and supports up to a 400mm x 400mm VESA mount configuration. The unit is held securely to a table edge using an innovative formed steel clamp which requires only 4.5" of surface depth above the worksurface and 1.5" underneath. The clamp is designed to work on any square edge surface between 3/4" and 1-1/4" thick.

Modesty Panel

The Tia modesty panel is available as an 18-gauge powder coated cold rolled steel sheet formed with a larger radius corner to match the top shape. The guest facing side of the modesty panel can be wrapped in Forbo linoleum.

Finish Guide

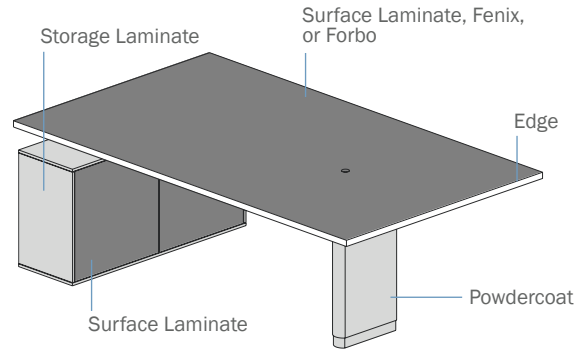
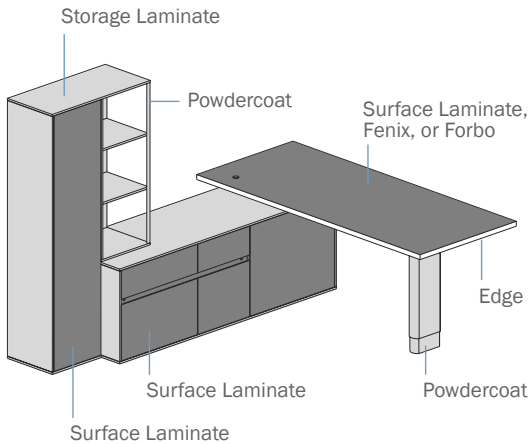

Surface Laminate

Alabaster	AB
Frosty White	FJ
Markerboard [§]	WM
Fashion Grey	FQ
Black	BK
Woodgrain	
White Cypress	WCS
Fawn Cypress	FCZ
Asian Sand	JS
Phantom Pearl	PPE
Phantom Ecru	PEC
Grey Elm	GEL
Field Elm	FLM
Loft Oak	LOA
Blond Echo	EH
Veranda Teak	VTK
Neo Walnut	NEW
Walnut Heights	WTH
Skyline Walnut	SKW
Studio Teak	DT
Ebony Recon	ERE
Craft Surface	
Espresso	ESP
Saddle	BKR

[§]Markerboard
+\$100 per surface
list upcharge

Fenix Laminate

Bianco Kos	MWH
Castoro Ottawa	MBR
Nero Ingo	MBK

*Fenix NTM Laminate

An extremely matte laminate with anti-finger-printing and anti-bacterial properties. **Upcharges by surface size:**
Under 30x72 +\$440 list
Over 30x72 +\$880 list

Forbo Linoleum

Forbo Ash	FAS
Forbo Pebble	FPE
Forbo Mushroom	FMU
Forbo Olive	FOL
Forbo Pewter	FPW
Forbo Noir	FNE
Forbo Smokey Blue	FSB

***Forbo Linoleum**
A super green material with a leather-like texture and a matte finish.
Upcharge: +\$250 list ea.

Storage Laminate

Alabaster	AB
Frosty White	FJ
Fashion Grey	FQ
Satin Gray	GY
Slate	SG
Woodgrain	
Charcoal	CH
Black	BK
Field Elm	FLM
Phantom Ecru	PEC
Blond Echo	EH
Fawn Cypress	FCZ
Studio Teak	DT
Walnut Heights	WTH

Edge Profile

90	90 °	U
	90 Trim	Q
	90 Ply °	V
Knife	Knife °	K
	Knife Trim °	J
	Knife Ply °	W
	Comfort °	P

*** MDF edge**
+\$100 per surface list upcharge

° 90 Ply & Knife Ply +\$350 per surface

°° Comfort Edge
Only available with Forbo Linoleum surface material.
+\$870 for Forbo with Comfort Edge per surface

Edge Trim Color

Stain	Charcoal [†]	CH
	Natural	ZE
Trim	Alabaster	AB
	Frosty White	FJ
	Fashion Grey	FQ
	Satin Gray	GY
	Slate	SG
	Charcoal	CH
	Black	BK
	Field Elm	FLM
	Phantom Ecru	PEC
	Blond Echo	EH
	Fawn Cypress	FCZ
	Studio Teak	DT
	Walnut Heights	WTH
Ply	Natural	ZE

[†]Charcoal Stain
+\$50 per surface
list upcharge

Powdercoat

Alabaster	AB
Frosty White	FJ
Markerboard	WM
Fashion Grey	FQ
Silver	WA
Satin Gray	GY
Slate	SG
Charcoal	CH
Black	BK
Aqua	AQU
Burnt Orange	REO
Mustard Seed	LEY
Emerald Green	PIG
Sage Green	PAG
Blue Steel	BLG
Stone	STG
Bark	BRK
Blush	BLU
Crema	CRE
Sapphire	SAP
Ruby	RBY

Fabric

Synergy 66*	Affix	AFI
	Alike	ALK
	Append	APP
	Chemistry	CHE
	Group	GRO
	Kinship	KIN
	Loop	LOO
	Mutual	MUT
	Pact	PAC
	Serendipity	SER
	Summon	SUM
	Work	WOR
Rivet	Tensile	TEN
	Vitreous	VIT
	Wire	WRE
	Forge	FRG
	Spark	SPK
	Molten	MLT
	Otter	OTR
	Alloy	ALY
	Grey Brindle	GRB
	Galvanize	GLV
	Lagoon	LGN
	Quench	QUE

***Synergy 66**
+\$250 per item
list upcharge

Fabric cont.

PET	Light	SIA63
	Medium	HTA23
	Dark	CHA21
Anchorage	Angora	9A
	Asteroid	6D
	Birch	9H
	Cumin	9U
	Fossil	6X
	Geranium	R2
	Goose	9E
	Graphite	9R
	Green Apple	1G
	Henna	6H
	Pumpkin	99
	Straw	9S
	Sunshine	S8
	Waterfall	U8
	Vanilla	6V
Sprite	Sprite Snow	2W
	Sprite Linen	2I
	Sprite Khaki	7K
	Sprite Harvest	2V
	Sprite Sky	7Y

Extended Powdercoat Program

Additional RAL colors are available as part of Watson's Extended Powdercoat Program. Please consult with your account manager to ensure your powder selection is available. Some pearls and metallics are not offered.

- **Upcharge: \$1760 list per order, per color**
- **Leadtime: Contact the Factory for Leadtime**

Tia Office

60W Drawer Support Credenza

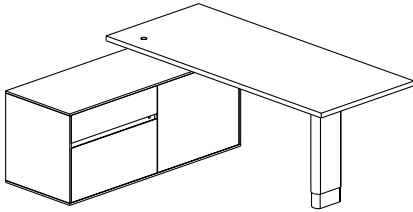

Options & Upcharges

Pull: Cove / Tab (Silver) / Tab (Black)

Power & Tech: Undersurface +\$760 / Grommet +\$55

Edge Profiles: 90 (+\$100) / 90 Trim / Knife (+\$100) / Knife Trim (+\$100) / 90 Ply (+\$350) / Knife Ply (+\$350) / Comfort (+\$870) (Comfort edge only available with Forbo surface material)

Notes

- Desk depth and width are net sized, and are an inch less in actual dimension
- HA model shown
- Unit is handed, specify left or right (L/R)

D	W	STORAGE HEIGHT	MODEL NUMBER	PRICE	PRICE
				HA	FIXED
30	60	24	APD2D603060	10290	8230
30	72	24	APD2D603072	10290	8230
30	84	24	APD2D603084	10690	8630
36	72	24	APD2D603672	10690	8630
36	84	24	APD2D603684	11370	9310
36	96	24	APD2D603696	11370	9310

Tia Office

72W Drawer Support Credenza

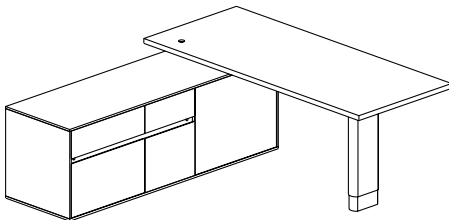

Options & Upcharges

Pull: Cove / Tab (Silver) / Tab (Black)

Power & Tech: Undersurface +\$760 / Grommet +\$55

Edge Profiles: 90 (+\$100) / 90 Trim / Knife (+\$100) / Knife Trim (+\$100) / 90 Ply (+\$350) / Knife Ply (+\$350) / Comfort (+\$870) (Comfort edge only available with Forbo surface material)

Notes

- Desk depth and width are net sized, and are an inch less in actual dimension
- HA model shown
- Unit is handed, specify left or right (L/R)

D	W	STORAGE HEIGHT	MODEL NUMBER	PRICE	PRICE
				HA	FIXED
30	60	24	APD2D723060	11640	9580
30	72	24	APD2D723072	11640	9580
30	84	24	APD2D723084	12040	9980
36	72	24	APD2D723672	12040	9980
36	84	24	APD2D723684	12710	10650
36	96	24	APD2D723696	12710	10650

Tia Office

72W Combo Support Credenza

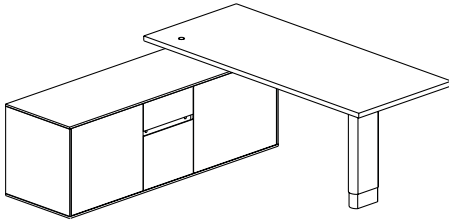

Options & Upcharges

Pull: Cove / Tab (Silver) / Tab (Black)

Power & Tech: Undersurface +\$760 / Grommet +\$55

Edge Profiles: 90 (+\$100) / 90 Trim / Knife (+\$100) / Knife Trim (+\$100) / 90 Ply (+\$350) / Knife Ply (+\$350) / Comfort (+\$870) (Comfort edge only available with Forbo surface material)

Notes

- Desk depth and width are net sized, and are an inch less in actual dimension
- HA model shown
- Unit is handed, specify left or right (L/R)

D	W	STORAGE HEIGHT	MODEL NUMBER	PRICE	
				HA	FIXED
30	60	24	APD2C723060	10480	8420
30	72	24	APD2C723072	10550	8490
30	84	24	APD2C723084	11120	9060
36	72	24	APD2C723672	11120	9060
36	84	24	APD2C723684	11770	9710
36	96	24	APD2C723696	11770	9710

Tia Office

84W Drawer Support Credenza

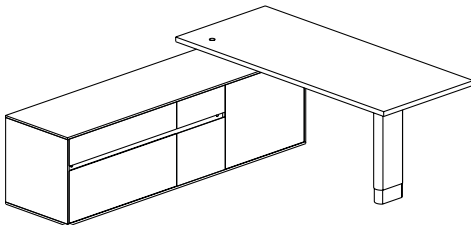

Options & Upcharges

Pull: Cove / Tab (Silver) / Tab (Black)

Power & Tech: Undersurface +\$760 / Grommet +\$55

Edge Profiles: 90 (+\$100) / 90 Trim / Knife (+\$100) / Knife Trim (+\$100) / 90 Ply (+\$350) / Knife Ply (+\$350) / Comfort (+\$870) (Comfort edge only available with Forbo surface material)

Notes

- Desk depth and width are net sized, and are an inch less in actual dimension
- HA model shown
- Unit is handed, specify left or right (L/R)

D	W	STORAGE HEIGHT	MODEL NUMBER	PRICE	
				HA	FIXED
30	60	24	APD2D843060	11770	9710
30	72	24	APD2D843072	11770	9710
30	84	24	APD2D843084	12180	10120
36	72	24	APD2D843672	12180	10120
36	84	24	APD2D843684	12840	10780
36	96	24	APD2D843696	12840	10780

Tia Office

84W Combo Support Credenza

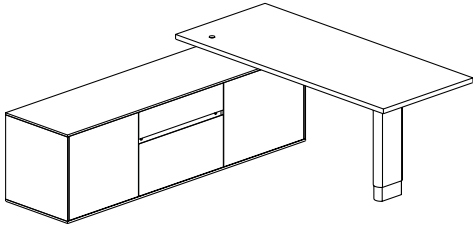

Options & Upcharges

Pull: Cove / Tab (Silver) / Tab (Black)

Power & Tech: Undersurface +\$760 / Grommet +\$55

Edge Profiles: 90 (+\$100) / 90 Trim / Knife (+\$100) / Knife Trim (+\$100) / 90 Ply (+\$350) / Knife Ply (+\$350) / Comfort (+\$870) (Comfort edge only available with Forbo surface material)

Notes

- Desk depth and width are net sized, and are an inch less in actual dimension
- HA model shown
- Unit is handed, specify left or right (L/R)

D	W	STORAGE HEIGHT	MODEL NUMBER	PRICE	PRICE
				HA	FIXED
30	60	24	APD2C843060	10820	8760
30	72	24	APD2C843072	10820	8760
30	84	24	APD2C843084	11240	9180
36	72	24	APD2C843672	11240	9180
36	84	24	APD2C843684	11900	9840
36	96	24	APD2C843696	11900	9840

Tia Office

96W Drawer Support Credenza

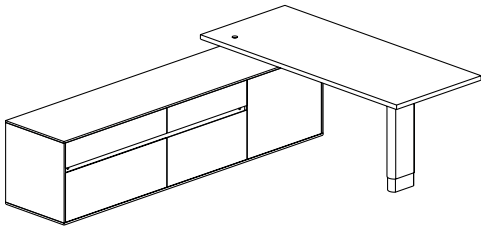

Options & Upcharges

Pull: Cove / Tab (Silver) / Tab (Black)

Power & Tech: Undersurface +\$760 / Grommet +\$55

Edge Profiles: 90 (+\$100) / 90 Trim / Knife (+\$100) / Knife Trim (+\$100) / 90 Ply (+\$350) / Knife Ply (+\$350) / Comfort (+\$870) (Comfort edge only available with Forbo surface material)

Notes

- Desk depth and width are net sized, and are an inch less in actual dimension
- HA model shown
- Unit is handed, specify left or right (L/R)

D	W	STORAGE HEIGHT	MODEL NUMBER	PRICE	PRICE
				HA	FIXED
30	60	24	APD2D963060	12040	9980
30	72	24	APD2D963072	12040	9980
30	84	24	APD2D963084	12450	10390
36	72	24	APD2D963672	12450	10390
36	84	24	APD2D963684	13110	11050
36	96	24	APD2D963696	13110	11050

Tia Office

96W Combo Support Credenza

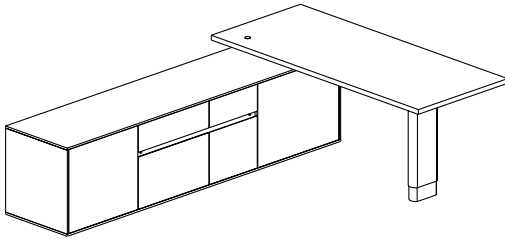

Options & Upcharges

Pull: Cove / Tab (Silver) / Tab (Black)

Power & Tech: Undersurface +\$760 / Grommet +\$55

Edge Profiles: 90 (+\$100) / 90 Trim / Knife (+\$100) / Knife Trim (+\$100) / 90 Ply (+\$350) / Knife Ply (+\$350) / Comfort (+\$870) (Comfort edge only available with Forbo surface material)

Notes

- Desk depth and width are net sized, and are an inch less in actual dimension
- HA model shown

D	W	STORAGE HEIGHT	MODEL NUMBER	PRICE HA	PRICE FIXED
30	60	24	APD2C963060	11900	9840
30	72	24	APD2C963072	12040	9980
30	84	24	APD2C963084	12450	10390
36	72	24	APD2C963672	12450	10390
36	84	24	APD2C963684	13110	11050
36	96	24	APD2C963696	13110	11050

Tia Modesty

Steel

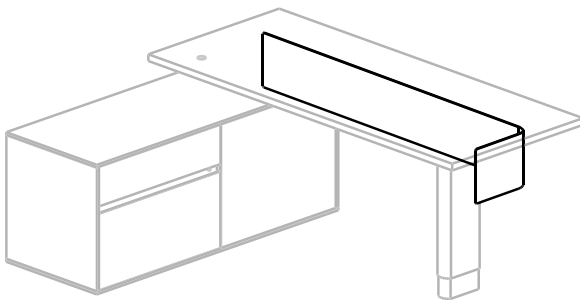

H	W	MODEL NUMBER (LEFT HAND)	MODEL NUMBER (RIGHT HAND)	PRICE
8	60	APMF0860L	APMF0860R	690
8	72	APMF0872L	APMF0872R	690
8	84	APMF0884L	APMF0884R	690
8	96	APMF0896L	APMF0896R	690

Tia Modesty

Steel with Forbo

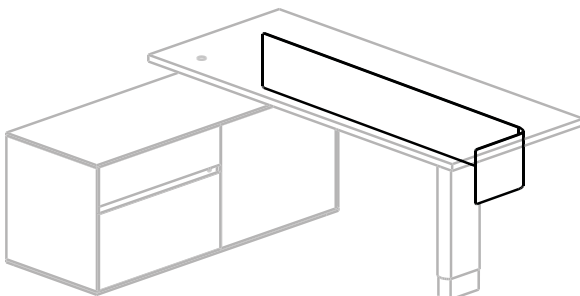

H	W	MODEL NUMBER (LEFT HAND)	MODEL NUMBER (RIGHT HAND)	PRICE
8	60	APMP0860L	APMP0860R	420
8	72	APMP0872L	APMP0872R	420
8	84	APMP0884L	APMP0884R	420
8	96	APMP0896L	APMP0896R	420

Tia Office

Credenza Removable Back

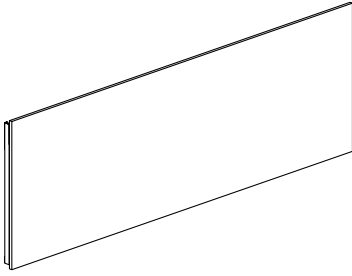

DESK DEPTH	W	H	MODEL NUMBER	PRICE
30	60	24	APD2CB306024	260
30	72	24	APD2CB307224	260
30	84	24	APD2CB308424	260
30	96	24	APD2CB309624	260
36	60	24	APD2CB366024	260
36	72	24	APD2CB367224	260
36	84	24	APD2CB368424	260
36	96	24	APD2CB369624	260

Clamp on Monitor Mount

For Tia Run-off Desk

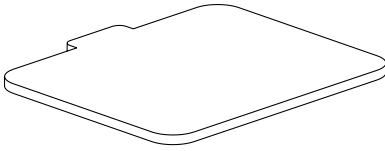

MODEL NUMBER	PRICE
APD2MM	45

Tia Free Standing Credenza

Door

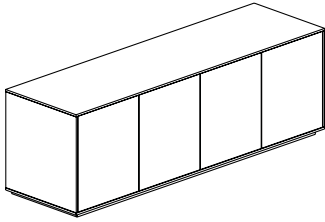

Options & Upcharges

Pull: Cove / Tab (Silver) / Tab (Black)

Notes

- 72W model shown

D	W	H	MODEL NUMBER	PRICE
20	60	24	APFS2D206024	2990
20	72	24	APFS2D207224	2990
20	84	24	APFS2D208424	2990

Tia Free Standing Credenza

Combo

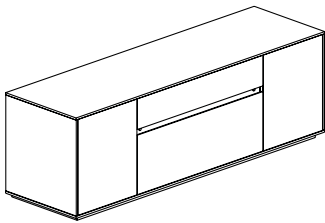

Options & Upcharges

Pull: Cove / Tab (Silver) / Tab (Black)

Notes

- 72W model shown

D	W	H	MODEL NUMBER	PRICE
20	60	24	APFS2C206024	4950
20	72	24	APFS2C207224	4950
20	84	24	APFS2C208424	4950

Tia Free Standing Credenza

Drawer

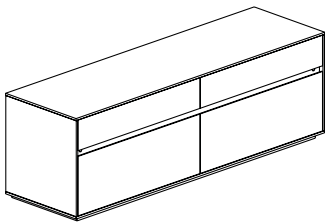

Options & Upcharges

Pull: Cove / Tab (Silver) / Tab (Black)

Notes

- 72W model shown
- Internal drawer widths are 28", 34", 40" respectively.

D	W	H	MODEL NUMBER	PRICE
20	60	24	APFS2F206024	5510
20	72	24	APFS2F207224	5510
20	84	24	APFS2F208424	5510

Tia Freestanding Credenza

Removable Back

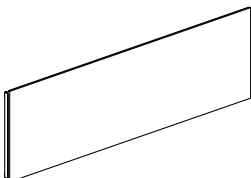

W	H	MODEL NUMBER	PRICE
60	24	APFS2CB6024	260
72	24	APFS2CB7224	260
84	24	APFS2CB8424	260

Tia Secondary Storage Stacker

Door / 15" Open

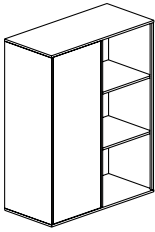

Options & Upcharges

Pull: Cove / Tab (Silver) / Tab (Black)

Notes

- 60H model shown
- Unit is handed, specify left or right (L/R)

D	W	H	MODEL NUMBER	PRICE
14	30	48	APSS2L143048	2070
14	30	60	APSS2L143060	2070
14	30	72	APSS2L143072	2070

Tia Secondary Storage Stacker

Door Pair

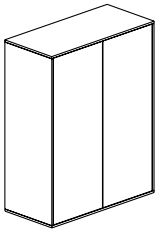

Options & Upcharges

Pull: Cove / Tab (Silver) / Tab (Black)

Notes

- 60H model shown

D	W	H	MODEL NUMBER	PRICE
14	30	48	APSS2D143048	2290
14	30	60	APSS2D143060	2290
14	30	72	APSS2D143072	2290

Tia Secondary Storage Stacker

Door / 24" Open

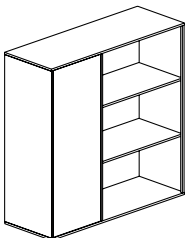

Options & Upcharges

Pull: Cove / Tab (Silver) / Tab (Black)

Notes

- 60H model shown
- Unit is handed, specify left or right (L/R)

D	W	H	MODEL NUMBER	PRICE
14	39	48	APSS2W143948	2070
14	39	60	APSS2W143960	2070
14	39	72	APSS2W143972	2070

Tia Secondary Storage Locker

15" Open / 15" Locker Door

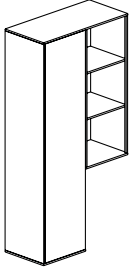

Options & Upcharges

Pull: Cove / Tab (Silver) / Tab (Black)

Notes

- 60H model shown
- Unit is handed, specify left or right (L/R)

D	W	H	MODEL NUMBER	PRICE
14	30	48	APSL20143048	2590
14	30	60	APSL20143060	2590
14	30	72	APSL20143072	2590

Tia Secondary Storage Locker

15" Door / 15" Locker Door

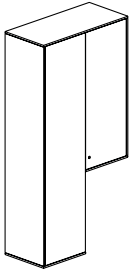

Options & Upcharges

Pull: Cove / Tab (Silver) / Tab (Black)

Notes

- 60H model shown
- Unit is handed, specify left or right (L/R)

D	W	H	MODEL NUMBER	PRICE
14	30	48	APSL2D143048	2890
14	30	60	APSL2D143060	2890
14	30	72	APSL2D143072	2890

Tia Secondary Storage Locker

24" Open / 15" Locker Door

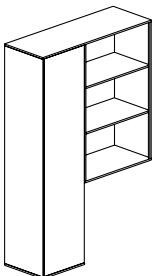

Options & Upcharges

Pull: Cove / Tab (Silver) / Tab (Black)

Notes

- 60H model shown
- Unit is handed, specify left or right (L/R)

D	W	H	MODEL NUMBER	PRICE
14	39	48	APSL2W143948	2590
14	39	60	APSL2W143960	2590
14	39	72	APSL2W143972	2590

Tia Secondary Storage Locker

15" Open / 15" Door / 15" Locker Door

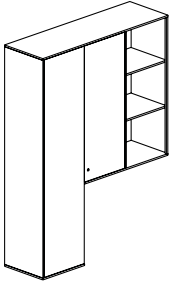

Options & Upcharges

Pull: Cove / Tab (Silver) / Tab (Black)

Notes

- 60H model shown
- Unit is handed, specify left or right (L/R)

D	W	H	MODEL NUMBER	PRICE
14	45	48	APSL2C144548	3210
14	45	60	APSL2C144560	3210
14	45	72	APSL2C144572	3210

Tia Secondary Storage Locker

24" Open / 15" Door / 15" Locker Door

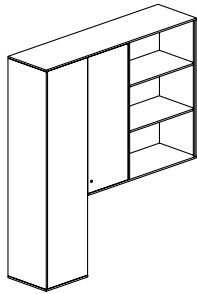

Options & Upcharges

Pull: Cove / Tab (Silver) / Tab (Black)

Notes

- 60H model shown
- Unit is handed, specify left or right (L/R)

D	W	H	MODEL NUMBER	PRICE
14	54	48	APSL2X145448	3500
14	54	60	APSL2X145460	3500
14	54	72	APSL2X145472	3500

Tia Secondary Storage Wardrobe

15" Open / 24" Wardrobe Door

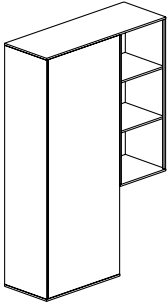

Options & Upcharges

Pull: Cove / Tab (Silver) / Tab (Black)

Notes

- 60H model shown
- Unit is handed, specify left or right (L/R)

D	W	H	MODEL NUMBER	PRICE
14	39	48	APSW20143948	2590
14	39	60	APSW20143960	2590
14	39	72	APSW20143972	2590

Tia Secondary Storage Wardrobe

15" Door / 24" Wardrobe Door

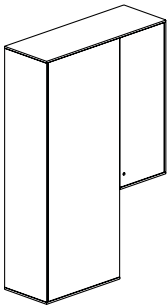

Options & Upcharges

Pull: Cove / Tab (Silver) / Tab (Black)

Notes

- 60H model shown
- Unit is handed, specify left or right (L/R)

D	W	H	MODEL NUMBER	PRICE
14	39	48	APSW2D143948	2890
14	39	60	APSW2D143960	2890
14	39	72	APSW2D143972	2890

Tia Secondary Storage Wardrobe

24" Open / 24" Wardrobe Door

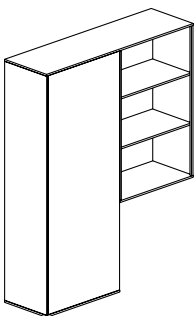

Options & Upcharges

Pull: Cove / Tab (Silver) / Tab (Black)

Notes

- 60H model shown
- Unit is handed, specify left or right (L/R)

D	W	H	MODEL NUMBER	PRICE
14	48	48	APSW2W144848	2590
14	48	60	APSW2W144860	2590
14	48	72	APSW2W144872	2590

Tia Secondary Storage Wardrobe

15" Open / 15" Door / 24" Wardrobe Door

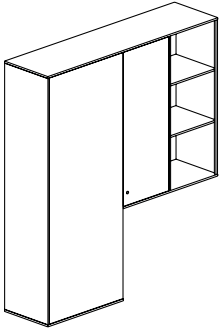

Options & Upcharges

Pull: Cove / Tab (Silver) / Tab (Black)

Notes

- 60H model shown
- Unit is handed, specify left or right (L/R)

D	W	H	MODEL NUMBER	PRICE
14	54	48	APSW2C145448	3500
14	54	60	APSW2C145460	3500
14	54	72	APSW2C145472	3500

Tia Secondary Storage Wardrobe

24" Open / 15" Door / 24" Wardrobe Door

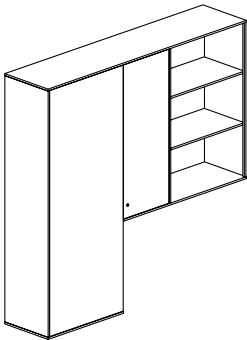

Options & Upcharges

Pull: Cove / Tab (Silver) / Tab (Black)

Notes

- 60H model shown
- Unit is handed, specify left or right (L/R)

D	W	H	MODEL NUMBER	PRICE
14	63	48	APSW2X146348	3500
14	63	60	APSW2X146360	3500
14	63	72	APSW2X146372	3500

Tia Team Table

Rectangular

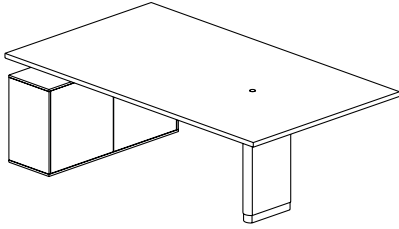

Options & Upcharges

Pull: Cove / Tab (Silver) / Tab (Black)

Power & Tech: Grommet +\$55 / See pages 37-38 for power options and pricing

Edge Profiles: Edge Profiles: 90 (+\$100) / 90 Trim / Knife (+\$100) / Knife Trim (+\$100) / 90 Ply (+\$350) / Knife Ply (+\$350) / Comfort (+\$870) (Comfort edge only available with Forbo surface material)

Notes

- HA model shown

D	W	STORAGE		MODEL NUMBER	PRICE	PRICE
		H			HA	FIXED
48	60	24		AMT2D4860	10290	8230
48	72	24		AMT2D4872	10290	8230
48	84	24		AMT2D4884	10290	8230
48	96	24		AMT2D4896	10290	8230

Tia Team Table

Tapered

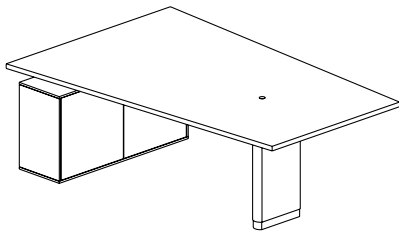

Options & Upcharges

Pull: Cove / Tab (Silver) / Tab (Black)

Power & Tech: Grommet +\$55 / See pages 37-38 for power options and pricing

Edge Profiles: 90 (+\$100) / 90 Trim / Knife (+\$100) / Knife Trim (+\$100) / 90 Ply (+\$350) / Knife Ply (+\$350) / Comfort (+\$870) (Comfort edge only available with Forbo surface material)

Notes

- HA model shown

D	W	STORAGE		MODEL NUMBER	PRICE	PRICE
		H			HA	FIXED
54	60	24		AMT2T5460	10290	8230
54	72	24		AMT2T5472	10290	8230
54	84	24		AMT2T5484	10290	8230
54	96	24		AMT2T5496	10290	8230

Tia Team Table

Super Ellipse

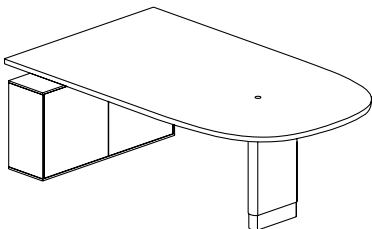

Options & Upcharges

Pull: Cove / Tab (Silver) / Tab (Black)

Power & Tech: Grommet +\$55 / See pages 37-38 for power options and pricing

Edge Profiles: 90 (+\$100) / 90 Trim / Knife (+\$100) / Knife Trim (+\$100) / 90 Ply (+\$350) / Knife Ply (+\$350) / Comfort (+\$870) (Comfort edge only available with Forbo surface material)

Notes

- HA model shown

D	W	STORAGE		MODEL NUMBER	PRICE	PRICE
		H			HA	FIXED
48	60	24		AMT2S4860	10290	8230
48	72	24		AMT2S4872	10290	8230
48	84	24		AMT2S4884	10290	8230
48	96	24		AMT2S4896	10290	8230

Tia Team Tech Cabinet

Removable Back

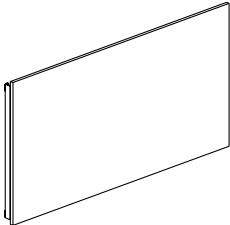

W	H	MODEL NUMBER	PRICE
42	24	AMRTB4224	270

Tia Team Table Monitor Mount

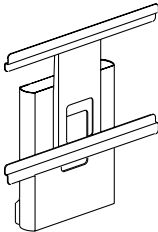

W	H	MODEL NUMBER	PRICE
14	18	AM2AV1418	1260

Tia Conference Table

Rectangular, One-Piece

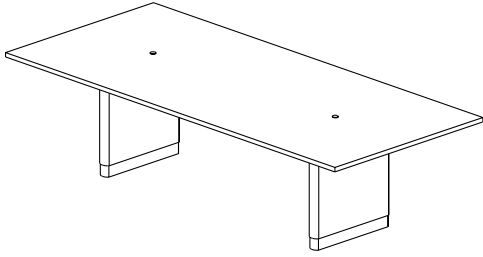

Options & Upcharges

Power & Tech: Grommet +\$55 / See pages 39-40 for power options and pricing

Edge Profiles: 90 (+\$100) / 90 Trim / Knife (+\$100) / Knife Trim (+\$100) / 90 Ply (+\$350) / Knife Ply (+\$350) / Comfort (+\$870) (Comfort edge only available with Forbo surface material)

D	W	MODEL NUMBER	PRICE HA	PRICE FIXED
42	84	ACTR4284	12220	8800
42	96	ACTR4296	12220	8800
42	108	ACTR42108	12220	8800
48	84	ACTR4884	12220	8800
48	96	ACTR4896	12220	8800
48	108	ACTR48108	12220	8800
54	84	ACTR5484	12220	8800
54	96	ACTR5496	12220	8800
54	108	ACTR54108	12220	8800
60	84	ACTR6084	12220	8800
60	96	ACTR6096	12220	8800
60	108	ACTR60108	12220	8800

Tia Conference Table

Rectangular, Two-Piece

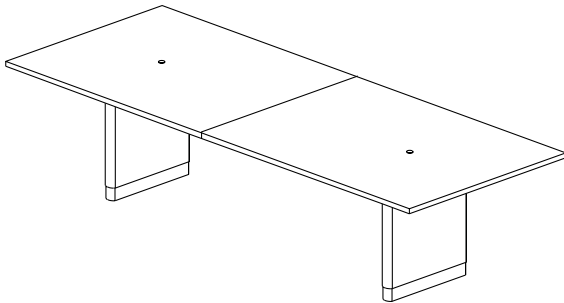

Options & Upcharges

Power & Tech: Grommet +\$55 / See pages 39-40 for power options and pricing

Edge Profiles: 90 (+\$200) / 90 Trim / Knife (+\$200) / Knife Trim (+\$200) / 90 Ply (+\$700) / Knife Ply (+\$700)

D	W	MODEL NUMBER	PRICE HA	PRICE FIXED
42	120	ACTR42120	12220	8800
42	132	ACTR42132	12220	8800
42	144	ACTR42144	12220	8800
48	120	ACTR48120	12220	8800
48	132	ACTR48132	12220	8800
48	144	ACTR48144	12220	8800
54	120	ACTR54120	12220	8800
54	132	ACTR54132	12220	8800
54	144	ACTR54144	12220	8800
60	120	ACTR60120	12220	8800
60	132	ACTR60132	12220	8800
60	144	ACTR60144	12220	8800

Tia Conference Table

Super Ellipse, One-Piece

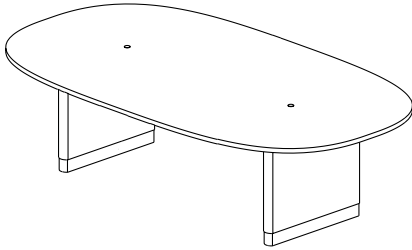

Options & Upcharges

Power & Tech: Grommet +\$55 / See pages 37-38 for power options and pricing

Edge Profiles: 90 (+\$100) / 90 Trim / Knife (+\$100) / Knife Trim (+\$100) / 90 Ply (+\$350) / Knife Ply (+\$350) / Comfort (+\$870) (Comfort edge only available with Forbo surface material)

D	W	MODEL NUMBER	PRICE HA	PRICE FIXED
48	84	ACTS4884	12220	8800
48	96	ACTS4896	12220	8800
48	108	ACTS48108	12220	8800
54	84	ACTS5484	12220	8800
54	96	ACTS5496	12220	8800
54	108	ACTS54108	12220	8800
60	84	ACTS6084	12220	8800
60	96	ACTS6096	12220	8800
60	108	ACTS60108	12220	8800

Tia Conference Table

Super Ellipse, Two-Piece

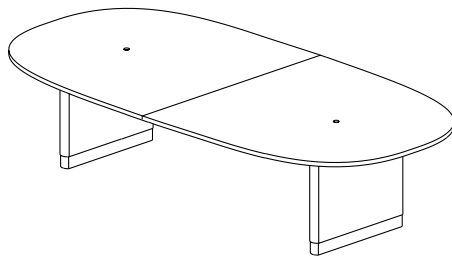

Options & Upcharges

Power & Tech: Grommet +\$55 / See pages 39-40 for power options and pricing

Edge Profiles: 90 (+\$200) / 90 Trim / Knife (+\$200) / Knife Trim (+\$200) / 90 Ply (+\$700) / Knife Ply (+\$700)

D	W	MODEL NUMBER	PRICE HA	PRICE FIXED
48	120	ACTS48120	12220	8800
48	132	ACTS48132	12220	8800
48	144	ACTS48144	12220	8800
54	120	ACTS54120	12220	8800
54	132	ACTS54132	12220	8800
54	144	ACTS54144	12220	8800
60	120	ACTS60120	12220	8800
60	132	ACTS60132	12220	8800
60	144	ACTS60144	12220	8800

Tia Conference Table

Tapered, One-Piece

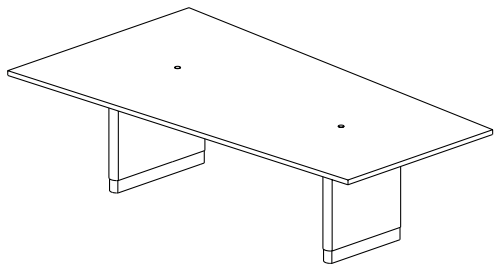

Options & Upcharges

Power & Tech: Grommet +\$55 / See pages 39-40 for power options and pricing

Edge Profiles: 90 (+\$100) / 90 Trim / Knife (+\$100) / Knife Trim (+\$100) / 90 Ply (+\$350) / Knife Ply (+\$350)

D	W	MODEL NUMBER	PRICE HA	PRICE FIXED
60	84	ACTT604884	12220	8800
60	96	ACTT604896	12220	8800
60	108	ACTT6048108	12220	8800

Tia Conference Table

Tapered, Two-Piece

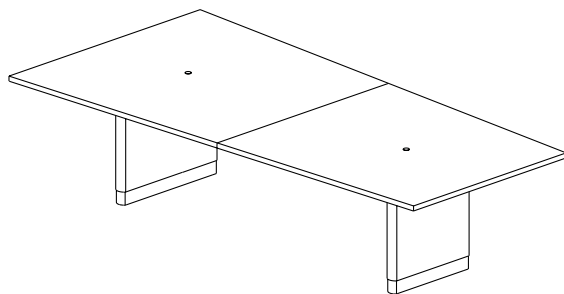

Options & Upcharges

Power & Tech: Grommet +\$55 / See pages 39-40 for power options and pricing

Edge Profiles: 90 (+\$200) / 90 Trim / Knife (+\$200) / Knife Trim (+\$200) / 90 Ply (+\$700) / Knife Ply (+\$700)

D	W	MODEL NUMBER	PRICE HA	PRICE FIXED
60	120	ACTT6048120	12220	8800
60	132	ACTT6048132	12220	8800
60	144	ACTT6048144	12220	8800

Tia Conference Table

Boat, One-Piece

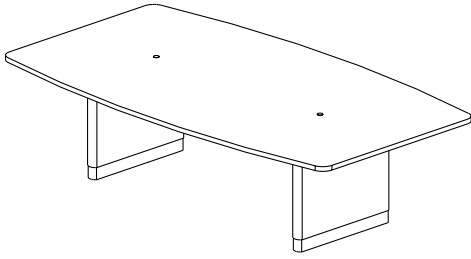

Options & Upcharges

Power & Tech: Grommet +\$55 / See pages 39-40 for power options and pricing

Edge Profiles: Edge Profiles: 90 (+\$100) / 90 Trim / Knife (+\$100) / Knife Trim (+\$100) / 90 Ply (+\$350) / Knife Ply (+\$350)

D	W	MODEL NUMBER	PRICE HA	PRICE FIXED
60	84	ACTB6084	12220	8800
60	96	ACTB6096	12220	8800
60	108	ACTB60108	12220	8800

Tia Conference Table

Boat, Two-Piece

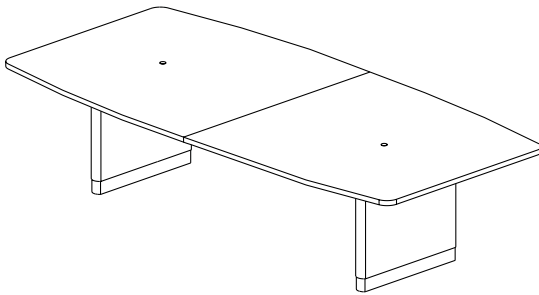

Options & Upcharges

Power & Tech: Grommet +\$55 / See pages 39-40 for power options and pricing

Edge Profiles: Edge Profiles: 90 (+\$200) / 90 Trim / Knife (+\$200) / Knife Trim (+\$200) / 90 Ply (+\$700) / Knife Ply (+\$700)

60	120	ACTB60120	12220	8800
60	132	ACTB60132	12220	8800
60	144	ACTB60144	12220	8800

Tia Conference Table

Riverstone

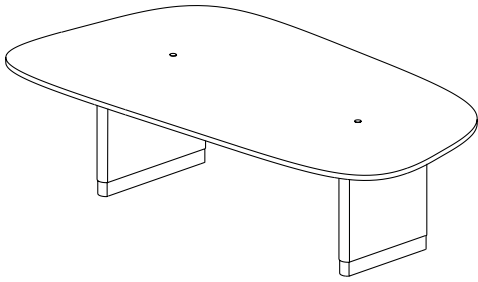

Options & Upcharges

Power & Tech: Grommet +\$55 / See pages 39-40 for power options and pricing

Edge Profiles: 90 (+\$100) / 90 Trim / Knife (+\$100) / Knife Trim (+\$100) / 90 Ply (+\$350) / Knife Ply (+\$350)

D	W	MODEL NUMBER	PRICE HA	PRICE FIXED
60	84	ACTRV6084	12220	8800
60	96	ACTRV6096	12220	8800
60	108	ACTRV60108	12220	8800

Tia Conference Table

Riverstone

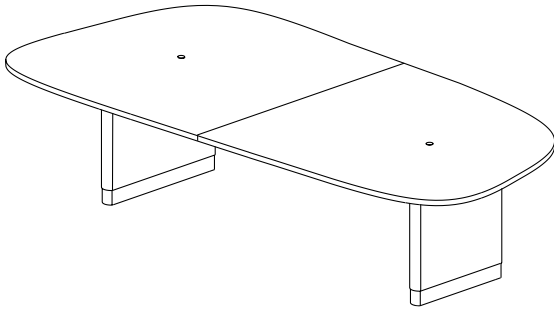

Options & Upcharges

Power & Tech: Grommet +\$55 / See pages 39-40 for power options and pricing

Edge Profiles: 90 (+\$200) / 90 Trim / Knife (+\$200) / Knife Trim (+\$200) / 90 Ply (+\$700) / Knife Ply (+\$700)

D	W	MODEL NUMBER	PRICE HA	PRICE FIXED
60	120	ACTRV60120	12220	8800

Tia Conference Table

Cable Pathway

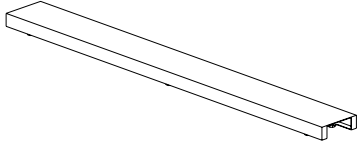

W	MODEL NUMBER	PRICE
84	ACCP84	700
96	ACCP96	700
108	ACCP108	700
120	ACCP120	700
132	ACCP132	700
144	ACCP144	700

Sideboard Credenza

Doors

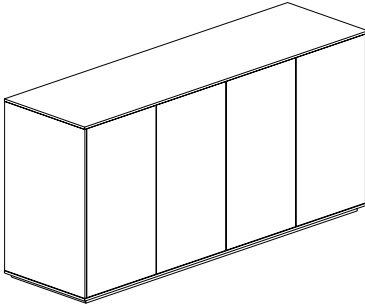

Options & Upcharges

Pull: Cove / Tab (Silver) / Tab (Black)

D	W	H	MODEL NUMBER	PRICE
20	60	36	ACFS2D206036	3410
20	72	36	ACFS2D207236	3410
20	84	36	ACFS2D208436	3410

Sideboard Credenza

Sideboard Removable Back

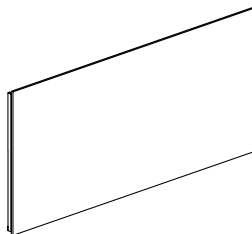

W	H	MODEL NUMBER	PRICE
60	36	ACRCB6036	340
72	36	ACRCB7236	340
84	36	ACRCB8436	340

In-Surface Dual-Hinge Power Units

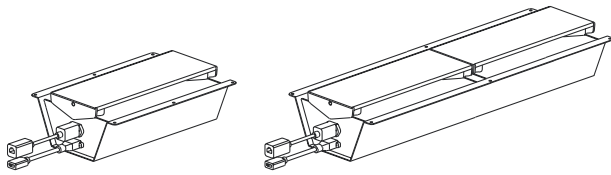

Single Unit

Double Unit: XL

POWER/DATA	MODEL NUMBER	LIST
FULL: 3 pwr, 2 USB, 1 HDMI, 1 CAT6E / 144" cord	WATF	1500
Full Chicago: 3 pwr, 2 USB, 1 HDMI, 1 CAT6E / 108" cord	WATC	1500
BASIC: Power Strip 4 pwr, 1 HDMI, 1 CAT6E, 10' Cord	WATS	1180
OPEN: 1 HDMI, 1 CAT6E	WATO	1020
XL Full : 6 pwr, 4 USB, 1 HDMI, 1 CAT6E / 144" cord	WATXLF	2520
XL Full Chicago: 6 pwr, 4 USB, 1 HDMI, 1 CAT6E / 108" cord	WATXLC	2520
XL Open: 1 HDMI, 1 CAT6E	WATXLO	1400

Byrne E2X Drop-In Power Units

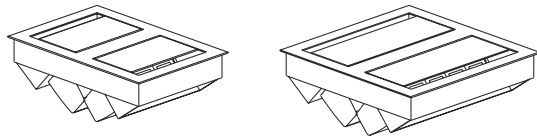

E2X - 3-port per side

E2X - 5-port per side

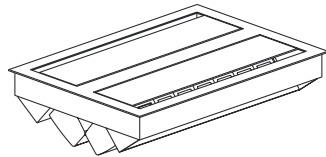

E2X - 8-port per side

Options & Upcharges

Power Connection Options: Plug-in / Hardwire +\$200/ Chicago

Notes

- All Byrne drop-in power units require surface cutout +\$55
- Finishes: Silver/Black, Silver/White, no upcharge. Black/Black +\$420

POWER/DATA	MODEL NUMBER	LIST
3-port per side: 2 PWR, 1 Dual USB per side	WPAE2X2P1D	1460
3-port per side: 2 PWR, 1 Open per side	WPAE2X2P10	1165
5-port per side: 3 PWR, 1 Dual USB, 1 Open per side	WPAE2X3P1D10	1565
5-port per side: 3 PWR, 2 Open per side	WPAE2X3P20	1280
8-port per side: 5 PWR, 1 Dual USB, 2 Open per side	WPAE2X5P1D20	1945
8-port: 5 PWR, 3 Open per side	WPAE2X5P30	1650

Byrne Ellora Drop-In Power Units

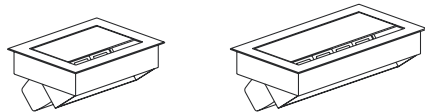

Ellora - 3-port

Ellora - 5-port

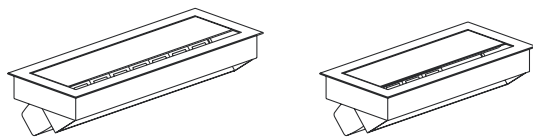

Ellora - 8-port

Ellora Qi

Options & Upcharges

Power Connection Options: Plug-in / Hardwire +\$100/ Chicago

Notes

- All Byrne drop-in power units require surface cutout +\$55
- Finishes: Silver/Black, Silver/White, no upcharge. Black/Black +\$120
- Units with Qi Charging require \$150 upcharge for Black

POWER/DATA	MODEL NUMBER	LIST
3-port: 2 PWR, 1 Open	WPAE2P10	685
5-port: 3 PWR, 1 Dual USB, 1 Open	WPAE3P1D10	850
5-port: 3 PWR, 2 Open	WPAE3P20	715
8-port: 5 PWR, 1 Dual USB, 2 Open	WPAE5P1D20	1460
8-port: 5 PWR, 3 Open	WPAE5P30	1315
Qi: 3 PWR, 1 Dual USB, 3 Qi coils	WPAEQ3P1D	1340
Qi: 3 PWR, 1 Open, 3 Qi coils	WPAEQ3P10	1220

Byrne MhoB Drop-In Power Units

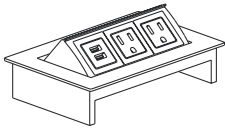

MhoB - 3-port

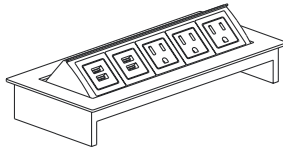

MhoB - 5-port

Options & Upcharges

Power Connection Options: Plug-in / Hardwire +\$100/ Chicago

Notes

- All Byrne drop-in power units require surface cutout +\$55

POWER/DATA	MODEL NUMBER	LIST
3-port: 2 PWR, 1 Open	WPAM2P10	495
3-port: 2 PWR, 1 Dual USB	WPAM2P1D	610
5-port: 3 PWR, 2 Open	WPAM3P20	525
5-port: 3 PWR, 2 Dual USB	WPAM3P2D	800

Byrne Minitap Drop-In Power Unit

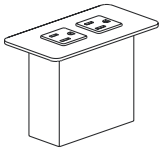

Options & Upcharges

Power Connection Options: Plug-in / Hardwire +\$100/ Chicago

Notes

- All Byrne drop-in power units require surface cutout +\$55

POWER/DATA	MODEL NUMBER	LIST
2 PWR	WPASMT2P	475

Byrne Node Drop-In Power Units



Options & Upcharges

Power Connection Options: Plug-in / Hardwire +\$100 Chicago

Notes

- All Byrne drop-in power units require surface cutout +\$55

POWER/DATA	MODEL NUMBER	LIST
2 PWR	WPANWP	345
1 PWR, 1 Dual USB	WPAN1P1D	475