



## Edison Workbench

The Edison Workbench combines adaptable efficiency and modern style in one inspiring design. Height-adjustable and fixed-height workstations can be configured in single-sided, dual-sided, or combination runs. Need to switch things up down the line? Just add or take away sections with zero fuss.



### Details

Opt for dual-sided or single-sided configurations, customize with an array of accessories, privacy screens, and end-of-run gallery panels, and keep everything clutter-free with robust cable management. The height-adjustable design, user-friendly power access, and intuitive starter-adder logic make the Edison Workbench an adaptable solution that delivers efficiency with style.

### Features

- Intuitive paddle switch controls height-adjustable workbenches, which have a height adjustment range of 23" - 49"
- Optional extended connector spans workbenches to allow nesting storage between them without disrupting power or data
- Easily attach or detach workbenches to or from one another (and with no additional components)
- Route cables through the power and accessory rail and up to the worksurface via the E-chain
- The power and accessory rail is available with 2 or 4 duplexes per user
- Compatible Edison accessories include the Neighborhood Light, planter boxes, gallery end panels, and portrait and landscape screens. These screens are available in fabric, acrylic, and markerboard finishes
- Supports worksurface-mounted screens, select screen tools, and includes an under-surface bag hook

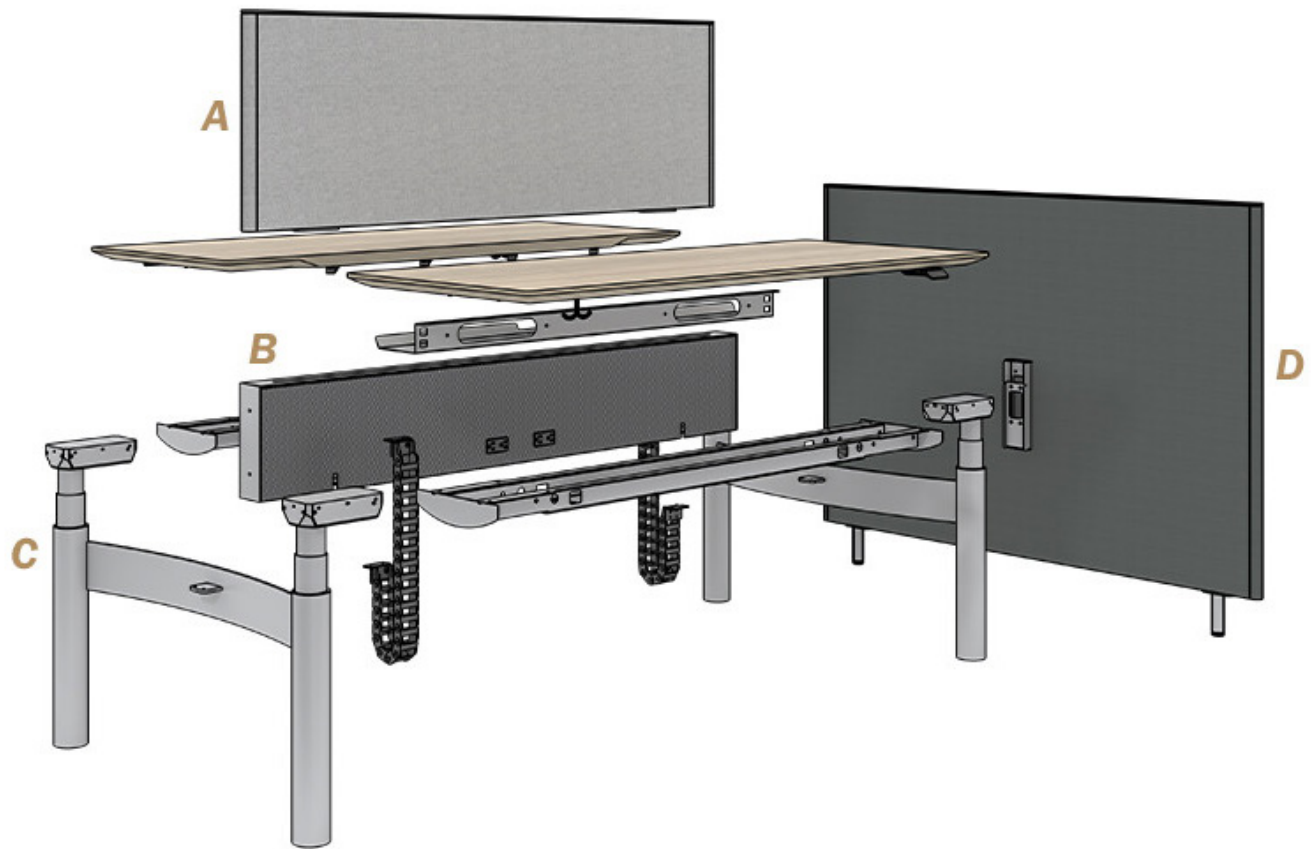

**A**

- Mounted accessories like screens and planter boxes can span multiple workbenches, or option the Neighborhood Light to add an inviting element at the end of a run

**B**

- Using a simple starter-adder logic, add or subtract workbenches from a run at any time without the need for any additional components
- Cables route through the power and accessory beam, available in perforated or solid steel, and up to the worksurface via the E-chain

**C**

- Height-adjustable workbenches have a range from 23" to 49" with built-in anti-collision technology. Fixed-height models are 29.5" in height

**D**

- Finish the end of the workbench with either a small metal plate that attaches to the end of the beam or a single or dual-sided gallery end panel

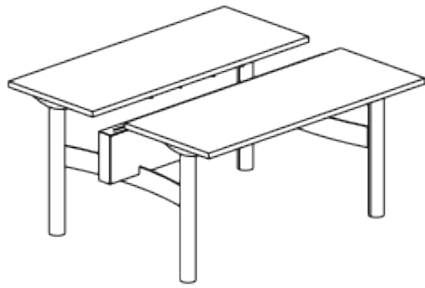

**Dual-sided Starter / Dual-sided Adder**  
**Fixed height, Rectangular**

**D:** 55, 67

**W:** 54, 60, 66, 72, 78, 84

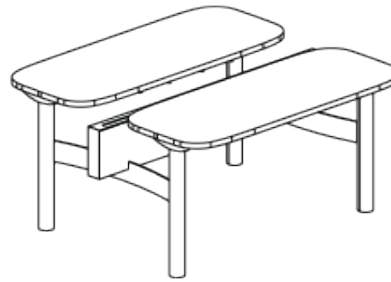

**Dual-sided Starter / Dual-sided Adder**  
**Fixed height, Super Ellipse**

**D:** 55, 67

**W:** 54, 60, 66, 72, 78, 84

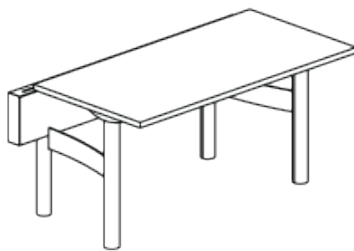

**Single-sided Starter / Dual-sided Adder**  
**Fixed height, Rectangular**

**D:** 29, 35

**W:** 54, 60, 66, 72, 78, 84



**Single-sided Starter / Dual-sided Adder**  
**Fixed height, Super Ellipse**

**D:** 29, 35

**W:** 54, 60, 66, 72, 78, 84

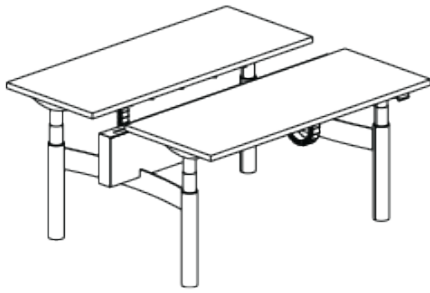

**Dual-sided Starter / Dual-sided Adder**  
Height adjustable, Rectangular

**D:** 55, 67

**W:** 54, 60, 66, 72, 78, 84

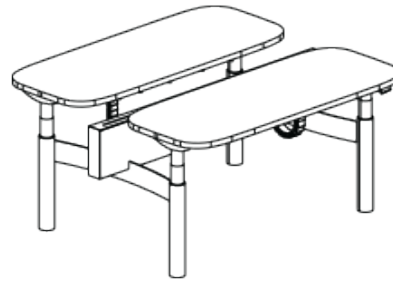

**Dual-sided Starter / Dual-sided Adder**  
Height adjustable, Super Ellipse

**D:** 55, 67

**W:** 54, 60, 66, 72, 78, 84

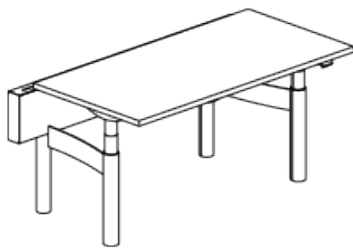

**Single-sided Starter / Dual-sided Adder**  
Height adjustable, Rectangular

**D:** 29, 35

**W:** 54, 60, 66, 72, 78, 84

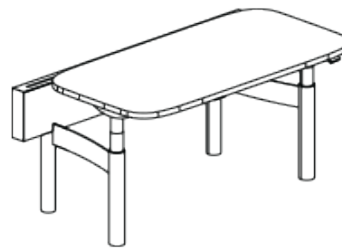

**Single-sided Starter / Dual-sided Adder**  
Height adjustable, Super Ellipse

**D:** 29, 35

**W:** 54, 60, 66, 72, 78, 84

**Universal Edison Accessories**

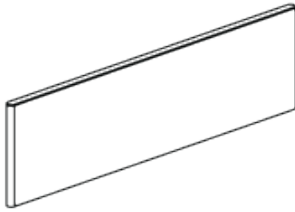

**Rail Screen**

**Rail Screen, Landscape  
Fabric**

**W: 24 - 96**

**H: 19, 25**

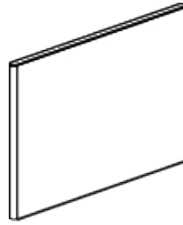

**Rail Screen, Portrait  
Fabric**

**W: 24 - 48**

**H: 31**

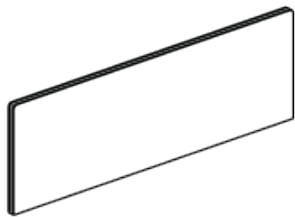

**Rail Screen, Landscape  
Markerboard Laminate**

**W: 24 - 96**

**H: 19, 25**

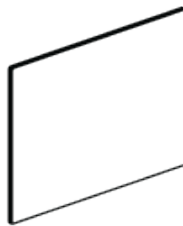

**Rail Screen, Portrait  
Markerboard Laminate**

**W: 24 - 48**

**H: 31**

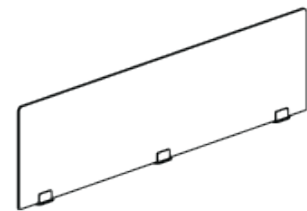

**Rail Screen, Landscape  
Acrylic**

**W: 24 - 96**

**H: 19, 25**

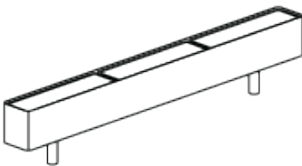

**Planter Box**

**D: 6**

**W: 18 - 90**

**H: 13**



**Neighborhood Light**

**DIA: 16**

**H: 42**

**Edison Workbench Surface Mounted Screens**

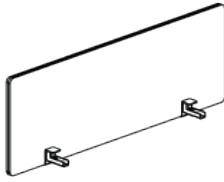

**Surface Mounted Straight Screens  
Landscape**

**W:** 24, 30, 36, 42, 48, 54, 60, 66, 72, 78, 84  
**H:** 20  
**HA:** 17

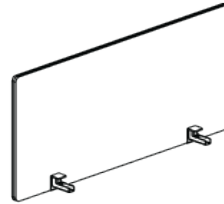

**Surface Mounted Straight Screens  
Gallery**

**W:** 54, 60, 66, 72, 78, 84  
**H:** 26  
**HA:** 23

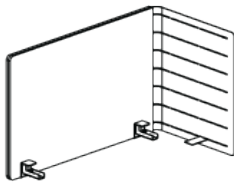

**Surface Mounted Corner Screens  
Single**

**W:** 54, 60, 66, 72, 78, 84  
**H:** 20, 26  
**HA:** 17, 23

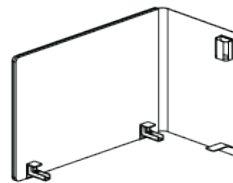

**Surface Mounted Corner Screens  
Single Markerboard**

**W:** 54, 60, 66, 72, 78, 84  
**H:** 20, 26  
**HA:** 17, 23

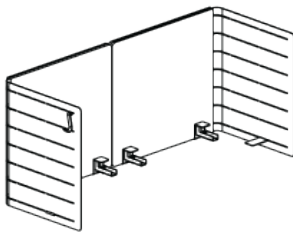

**Surface Mounted Corner Screens  
Double**

**W:** 54, 60, 66, 72, 78, 84  
**H:** 20, 26  
**HA:** 17, 23

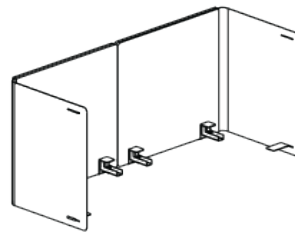

**Surface Mounted Corner Screens  
Double Markerboard**

**W:** 54, 60, 66, 72, 78, 84  
**H:** 20, 26  
**HA:** 17, 23

**Surface Mounted Side Screen**

**W:** 24, 30  
**H:** 13, 18  
**HA:** 12, 17

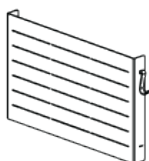

### Edison Workbench Optional Accessories



Workbench End Plate  
(Starter includes 2)

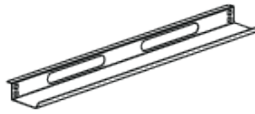

Cable Tray

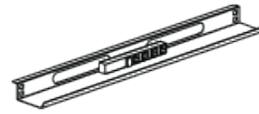

Cable Tray with  
Utility Power

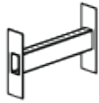

Extend Connector  
W: 15

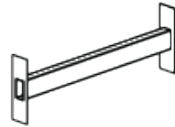

Extend Connector  
W: 30

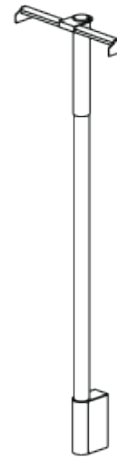

Power Pole