

ALLÉ

Spec Guide & Price List

Work + Meet + Mobile + Lounge



ALLÉ SPEC GUIDE

Statement of Line.....	3
Work Desk.....	5
Meet Table.....	7
Meet-Up Table.....	8
Mobile Planter	11
Mobile Monitor Wall.....	12
Mobile Pin + Write Boards.....	14
Sofa.....	15
Hopper.....	16
Finish Guide.....	19

ALLÉ PRICE LIST

Work Desk.....	23
Meet Table.....	24
Meet-Up Table.....	25
Mobile.....	26
Lounge.....	28
Power.....	29

Click title to jump to page

Prices effective January 2025

*For payment, shipping, and warranty information,
please see our [Terms & Conditions](#).*

Allé Statement of Line

Allé Work Desk

With glides

D: 24, 30

W: 48, 54, 60, 66, 72

H: 29.5

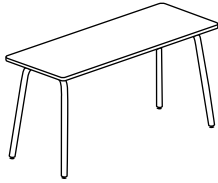

With casters

D: 24, 30

W: 48, 54, 60, 66, 72

H: 29.5

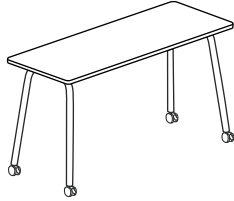

Allé Meet Table

With glides

D: 30, 36, 42, 48, 54, 60

W: 30 - 96

H: 29.5

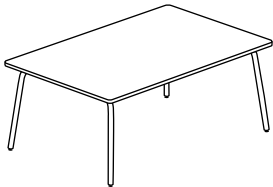

With casters

D: 30, 36, 42, 48, 54, 60

W: 30 - 96

H: 29.5

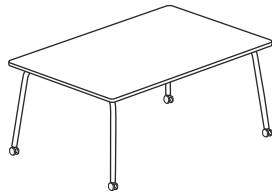

With footbar and glides

D: 30, 36, 42, 48, 54, 60

W: 30 - 96

H: 36, 42

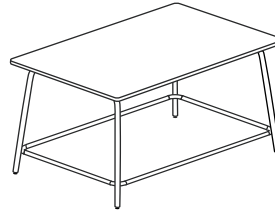

With footbar and casters

D: 30, 36, 42, 48, 54, 60

W: 30 - 96

H: 36, 42

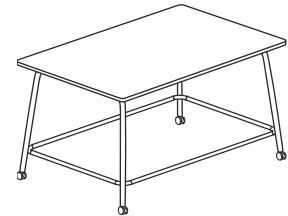

Allé Meet-Up Table

Height Adjustable

D: 60

W: 60, 72, 78, 84, 96

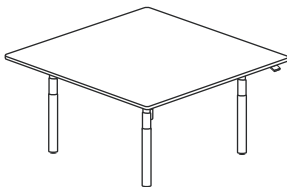

Allé Mobile Planter

Four Tier

D: 24

W: 55

H: 72

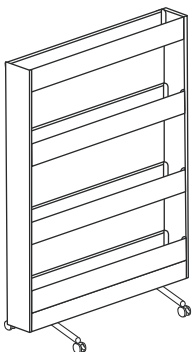

Three Tier

D: 24

W: 55

H: 52

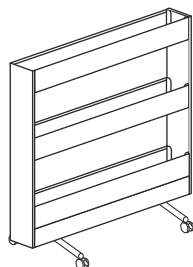

Single Tray

D: 8

W: 27

H: 5

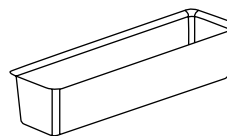

Allé Statement of Line

Allé Mobile Monitor Wall

D: 24
W: 56, 68
H: 72

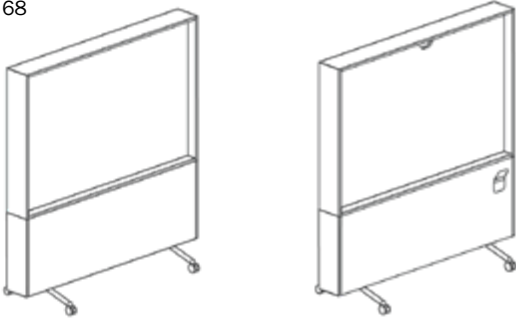

Allé Mobile Pin and Write Boards

Pin, Write
D: 16.5
W: 48
H: 72

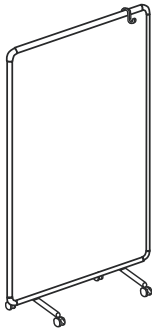

Allé Hopper

D: 16
W: 22
H: 28



Allé Sofa

Double
D: 40
W: 68

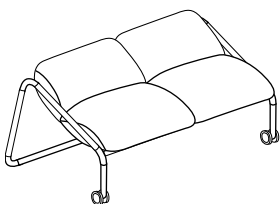



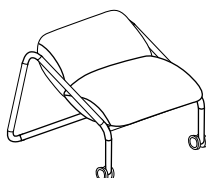





Single
D: 40
W: 36



Allé Work Desk

Edge options

-  Allé 90
-  Allé 90 Ply
-  Allé 90 Trim
-  Allé 90 Trim Square Corner
-  Allé Knife
-  Allé 90 Knife Trim
-  Allé 90 Knife Ply
-  Allé Round Under
-  Allé 90 Round Under Ply

Allé surfaces are 3/4" thick.

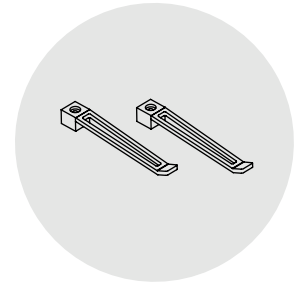
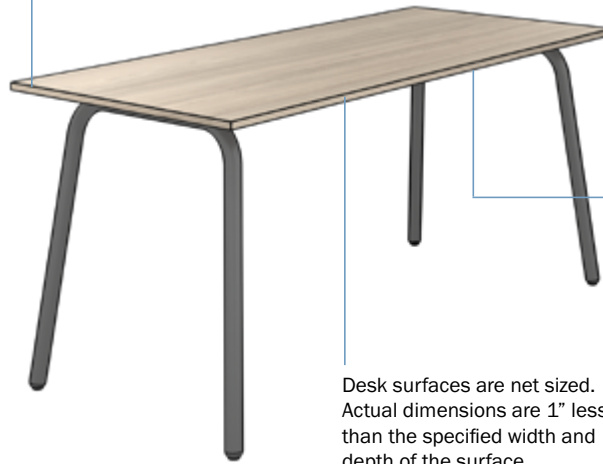

Work Desks include cable clips under the surface. If additional cable management is required, add the universal cable tray (WAWH)

Desk surfaces are net sized. Actual dimensions are 1" less than the specified width and depth of the surface.



Optional user power can be specified as convenience power (clamps onto the back of the desk) or utility power (secured to the universal cable tray).

Allé Work Desk

D: 24, 30

W: 48, 54, 60, 66, 72

H: 29.5

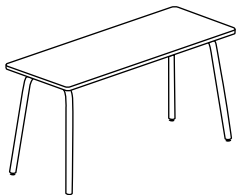

Cable Channel

The Vertical Cable Channel can be attached to the legs of work desk and meet tables to discreetly route cables from the surface to the floor. ([Learn more here](#))

- Easily clips on without need for hardware



Casters

Casters are optional for increased mobility and are available in white or black. The overall height of the desk is maintained at 29.5"

Grommet Locations

All grommets are sized at 60mm in diameter, constructed of black plastic and come standard with a grommet cover. For alternate grommet locations, you can order DAGR grommets (comes as set of 5 when ordering quantity of 1) separately and install them in the field.

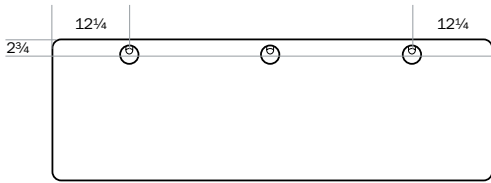

Rectangle, 24" D

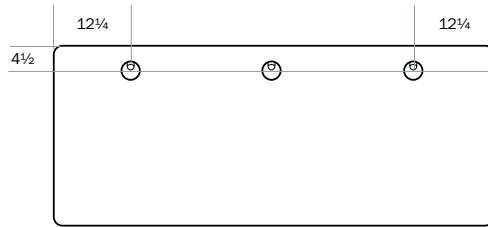









Rectangle, 30" D

All desks can be specified with grommet(s) left, right, or centered.

Allé Meet Table

Edge options

-  Allé 90
-  Allé 90 Ply
-  Allé 90 Trim
-  Allé 90 Trim Square Corner
-  Allé Knife
-  Allé 90 Knife Trim
-  Allé 90 Knife Ply
-  Allé Round Under
-  Allé 90 Round Under Ply

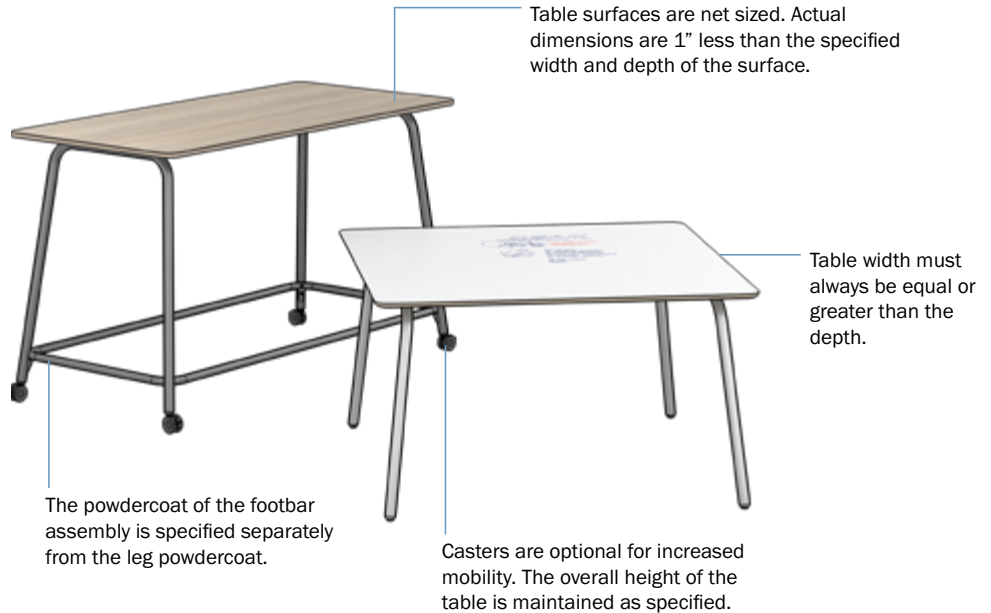

Allé Meet Table

D: 30, 36, 42, 48, 54, 60

W: 30 - 90

H: 29.5, 36, 42*

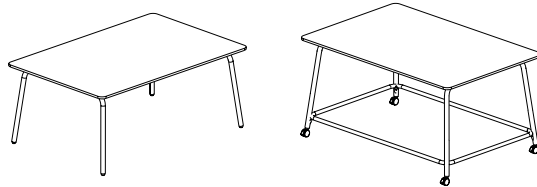

Table Height Options

42"

36"

29.5"

Height options include 29.5", 36", and 42".

*36 and 42" high tables come standard with a footbar.

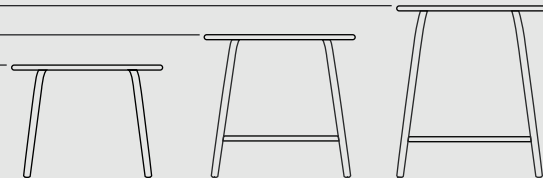

Cable Channel

The Vertical Cable Channel can be attached to the legs of work desk and meet tables to discreetly route cables from the surface to the floor. ([Learn more here](#))

- Easily clips on without need for hardware
- Options for each Meet Table height











Casters

Casters are optional for increased mobility and are available in white or black. The overall height of the table is maintained as specified.

Allé Meet-Up Table

Edge options

-  Allé 90
-  Allé 90 Ply
-  Allé 90 Trim
-  Allé 90 Trim Square Corner
-  Allé Knife
-  Allé 90 Knife Trim
-  Allé 90 Knife Ply
-  Allé Round Under
-  Allé 90 Round Under Ply

The universal monitor mount (FLAV) can be added to the meet-up table. It holds screens up to 55" and can be attached to any side of the table.

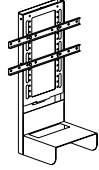

Lifting columns come in standard powdercoat of black, white or silver. If another finish is desired, an outer steel shroud is added and available in any standard Watson powdercoat.

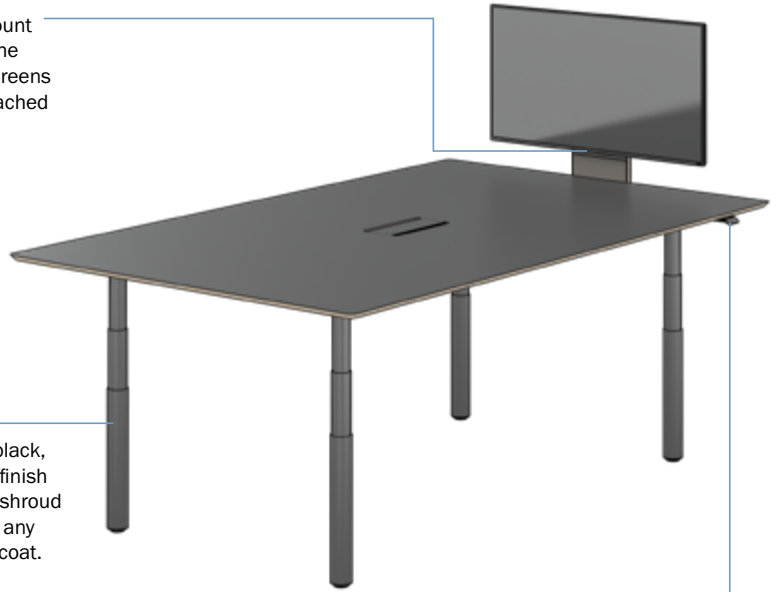

The Meet-up Table includes 2 switches for height adjustability, which are located on the right end of each side of the table width. Specify an embedded or paddle switch to adjust the table height.

A single drop in power unit can be added to the center of the table. See page 9 for standard meeting and conference power options.



Meet-Up Table

D: 60

W: 60, 72, 84, 96

HA: 23 - 49

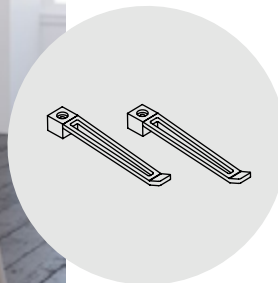
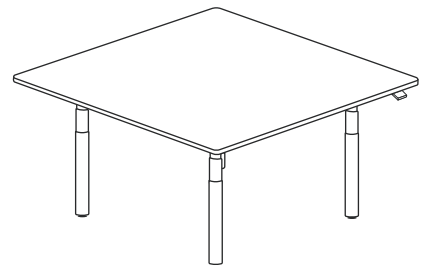

The Meet-Up table comes standard with cable clips. If additional cable management is needed, select from the options below.

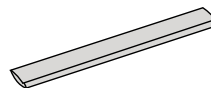

If the table is next to a gallery end panel with power, specify the fabric cable sleeve WACMF43.



For a freestanding application, specify the WHACM cable manager.

Allé Conference and Meeting Power

The Dual-hinge power unit is Watson's unique 2-way access to Allé in-surface power/data. Lids are grain-matched to the worksurface and house ample space beneath for excess cables and remotes. Available in a single unit, or double unit (XL, shown below) depending on power/data needs.

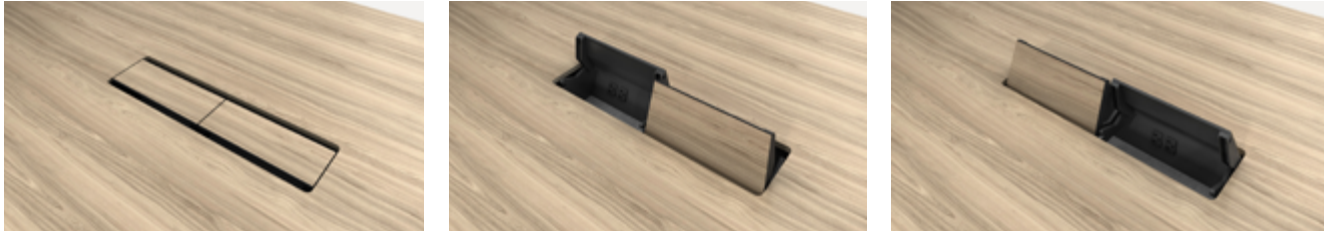

Available in the following three power/data configurations:

Dual-hinge Full

3 Power
USB A+C
1 HDMI
1 CAT6



Dual-hinge Basic

Commercial 4 power plug strip
1 HDMI
1 CAT6
10' Cord



Dual-hinge Open (no power)

1 HDMI
1 CAT6



Power Locations

Meet Tables surface can be specified with a drop-in power unit, centered along the surface depth. See the full range of Watson's standard meeting and conference power options on page 31 of the pricer.

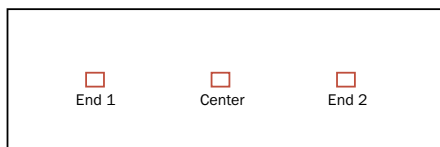

Meet Table

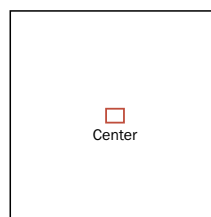

Meet-Up Table

- Dual-hinge is only possible in the Center location
- When width is 66" or greater, End 1 and End 2 become available with exceptions which can be fully specified in CET

Work Desk / Meet Table

The Work Desk and Meet Table come with a worksurface top constructed from any of the following core materials depending on options: 18 mm European birch multi-ply plywood with a waterborne edge stain, ¾" double refined NAF MDF with a waterborne edge stain or ¾" M2 industrial NAF particle board with a 1.5mm polypropylene edge band. All of these core materials are finished with either horizontal or post-form grade high pressure laminate or Forbo furniture linoleum on the top face and a horizontal grade backer sheet for balanced construction.

The frame has two fixed height bent tube bridge legs tied together with horizontal support tubes fastened to the underside of the worksurface. Both the bridge legs and the support tubes are composed of 40mm steel tube.

A threaded cast aluminum insert mates with the bottom end of each bridge leg and accepts either a pivoting head glide with 30mm of stem length adjustment or a 65mm diameter swivel caster with locking capabilities.

The optional foot bar available on Meet Tables at heights of 36" and 42" consists of four 1.25" steel tubes and a cast aluminum connector that mechanically fastens to each of the four legs.

The Work Desk is compatible with an undersurface mounted cable tray constructed of bent 16 gauge cold rolled steel. The cable tray is optioned with a Tripp Lite 4 outlet power distribution unit and includes strain relief mount points for cable bundling and organization. (Sold separately)

Meet-Up Table

The worksurfaces are available in a core material type of 0.75" NAF MDF, 0.75" NAF particleboard, or 18mm Euro birch plywood and is available in all standard surface finishes. Support rails are comprised of bent 12-gauge cold rolled steel and 1.25" x 2" tubing. The support rail reinforces the worksurface from the underside. It is mounted directly to the underside of the worksurface through brass inserts and lifting columns and the control box mount directly to support rail. There are 3 switch options to control the lifting columns: an embedded button, a Display Paddle switch with Bluetooth connectivity, or a standard Paddle switch with Bluetooth connectivity. The bottom of the legs are shrouded with a 3" hollow steel tube if the power finish isn't frosty white, black, or silver.

Mobile Planter



Without the planter trays, the mobile planter can be used for storing and organizing reference materials and supplies.

Optional planter trays (always black) complete the unit and provide a waterproof insert for the sheet metal troughs. Planter trays accommodate 5.25" diameter pots or can be planted in directly.

Wheels can be either black or white.

Mobile Planter

D: 24" (including base)

W: 55"

H: 3 Tier: 52" H, 4 Tier: 72" H

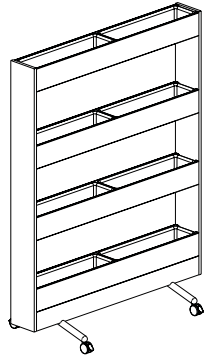
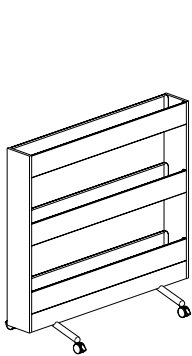

*shown with optional planter trays

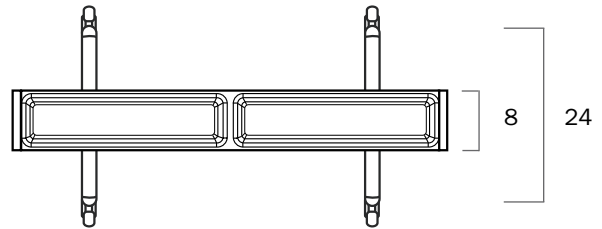

Mobile Monitor Wall Details

The Mobile Monitor wall is available in two widths which determine the largest possible tv monitor size they can accommodate.

56"W x 72"H x 24"D for up to 55" Monitor
 68"W x 72"H x 24"D for up to 65" Monitor

Excess cord can be looped around the integrated cord manager to keep it up off the floor.

Integrated A/V mount supports a wide range of VESA mounting patterns (max 600 x 400mm) and flexibility in monitor mounting locations.

Optional convenience power can be specified to provide HDMI, USB A+C and 2 simplex mounted below the monitor.



The mid panel is inset from the edge of the case by 3". To ensure the tv does not extend beyond the case, select a shallow depth tv monitor.

The back side of the mobile monitor wall features a tackable fabric panel. Behind this panel is a utility power strip with 4 simplexes.

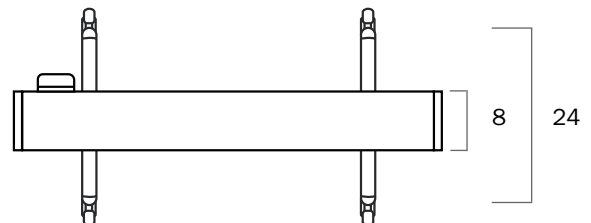
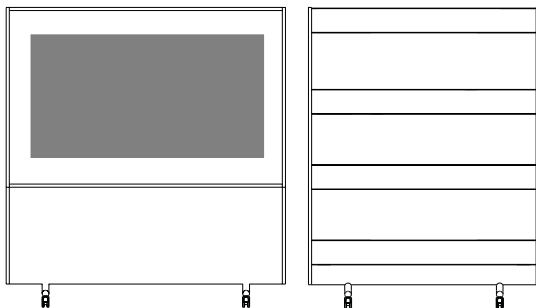

- When placed side by side, the Mobile Monitor Wall and the 4 tier, 72"H Mobile Planter align creating functional space division.

Mobile Planter

The lower horizontal panels and side vertical panels on the Mobile Planter are built from wood composite board that is 100% recycled industrial by-product from local milling operations located within our Pacific Northwest region. The wood board contains 90-95% recycled content that in turn may be recycled again. Boards are finished with GreenGuard™ certified laminates. Laminates are fused to surfaces using water-based, non-toxic and ultra-low VOC emitting adhesive.

The pair of mobile legs mechanically fasten to hardware embedded in the lower case assembly and are tied together with an aluminum extrusion housed inside of the assembly for additional support. The legs are composed of 40mm steel tube, and 65mm diameter swivel casters with locking capabilities that thread into cast aluminum end caps.

Optional black high impact polystyrene (HIPS) plastic planter trays provide a sturdy and waterproof container for planter pots up to 5.25" in diameter or allow for direct planting inside of the tray.

The planter trays nest inside troughs that are composed of bent 16 gauge cold rolled steel. These troughs are mechanically fastened to the side vertical panels.

Monitor Wall

The Monitor Wall is built from wood composite board that is 100% recycled industrial by-product from local milling operations located within our Pacific Northwest region. The wood board contains 90-95% recycled content that in turn may be recycled again. Boards are finished with GreenGuard™ certified laminates. Laminates are fused to surfaces using water-based, non-toxic and ultra-low VOC emitting adhesive.

The pair of mobile legs mechanically fasten to hardware embedded in the lower case assembly and are tied together with an aluminum extrusion housed inside of the assembly for additional support. The legs are composed of 40mm steel tube, and 65mm diameter swivel casters with locking capabilities that thread into cast aluminum elements.

Each Monitor Wall comes standard with a Tripp Lite four outlet power distribution unit (PDU) located behind the removable fabric panel on the backside of the upper case assembly. An additional convenience power unit is also optionable. The in-surface power solution unit mounted into the front panel of the unit (situated directly beneath the monitor) that features two power outlets, HDMI, and a combo USB-A + USB-C ports. The system integrates to a three outlet Triplex unit (instead of the standard Tripp Lite PDU) also behind the removable fabric panel on the backside of the upper case assembly.

A tackable, removable fabric panel is located on the backside of the upper case assembly. The fabric panel is constructed from two pieces of 12mm LDF wrapped in fabric using a non-VOC emitting rubber emulsion Simalfa glue.

A bent 12 gauge cold rolled steel cable manager bracket mechanically fastens to the backside of the lower case assembly. The powder finish of this bracket matches the finish selected for the mobile legs.

An AV mounting solution is mechanically fastened to the center panel of the Monitor Wall. It is constructed of bent 12 gauge cold rolled steel brackets. The mount accommodates a max VESA mounting pattern of 600x400mm.

Mobile Pin + Write Boards

Mobile Boards can be specified in a single material or a combination of tackable fabric or magnetic markerboard faces.

Mobile Pin boards are available in any standard Watson Fabric.

The mobile boards are lightweight and easy to move. Four locking casters (65mm) are available in white or black.



A PET coathook is included with each mobile board and comes in Light Gray when white casters are selected or Charcoal when black casters are selected.

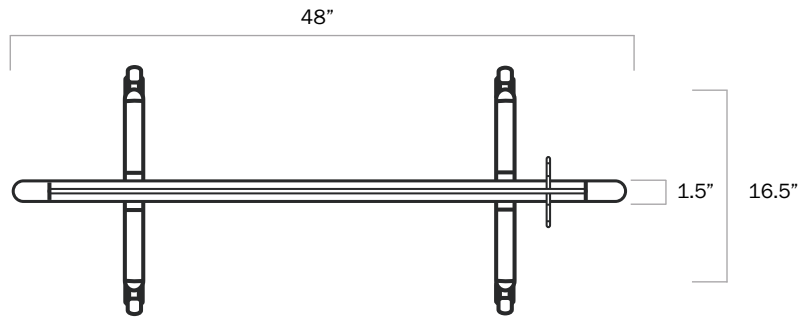

- Mobile boards can be offset and nested to save space.

Sofa

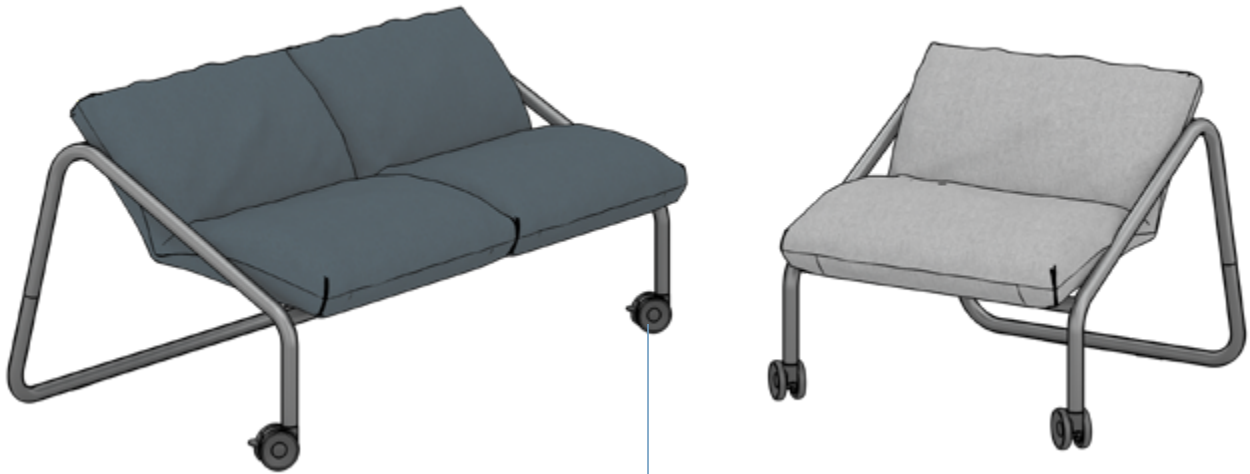

The Sofa(s) feature oversized 100mm front, locking casters (available in black) to allow for ease of mobility.

The Hopper, Sofa and Sofa Single are offered in a limited selection of upholstery fabrics:

Synergy66



Chemistry LDP35



Work LDP73

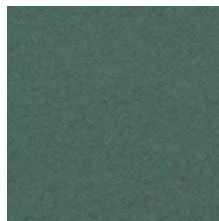

Append LDP49



Serendipity LDP08



Group LDP59

Rivet

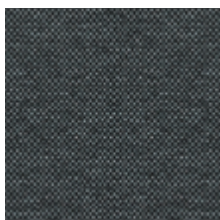

Grey brindle EGL50



Vitreous EGL01



Quench EGL23

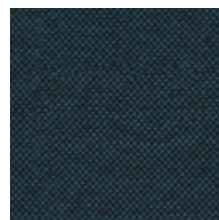

Lagoon EGL35

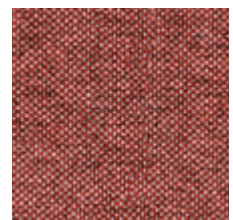

Forge EGL12

Hopper

Hoppers are 27.5" tall

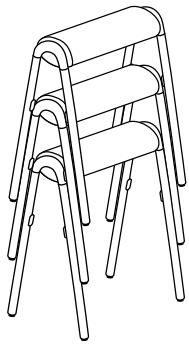

- Hoppers stack for easy storage. Bumpers on the inside of each leg prevent marring.

The Hopper, Sofa and Sofa Single are offered in a limited selection of upholstery fabrics:

Synergy66



Chemistry LDP35



Work LDP73

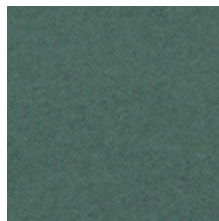

Append LDP49



Serendipity LDP08



Group LDP59

Rivet

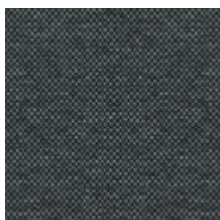

Grey brindle EGL50



Vitreous EGL01

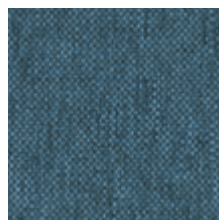

Quench EGL23



Lagoon EGL35

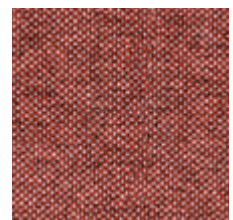

Forge EGL12

Pin and Write Boards

The frame of the Pin and Write boards are comprised of 6063-T6 aluminum extrusions mechanically fastened to cast aluminum corner connectors. The core board is comprised of a stack of recycled corrugated cardpaper layers providing excellent tackability and lightweight transport. Depending on product optioning, this core board will be covered by fabric or a magnetic markerboard sheet metal adhered with non-VOC emitting rubber emulsion Simalfa glue.

The pair of mobile legs mechanically fasten to the lower horizontal frame extrusion. The legs are composed of 40mm steel tube, and 65mm diameter swivel casters with locking capabilities that thread into cast aluminum end caps.

Each board comes standard with a black or gray PET felt coat hook that press-fits into a slot in the upper horizontal frame extrusion.

Sofa

The frame consists of three bent 40mm steel tube pieces that are connected by POM plastic press-in fittings. A 40mm steel horizontal support tube is mechanically fastened to the bent tube frame. Two 100mm diameter locking black swivel casters are secured into POM plastic fittings on the front side of the Sofa.

Depending on optioning, the Sofa contains one or two sewn assemblies consisting of an outer polyester fabric, a 3D polyester non-slip support mesh fabric, and zippers for easy access to the cushions. The cushions are 100% polyester fill. In the case of a two cushion Sofa model, the cushions are secured together in the middle of the unit by two hook and loop fastening straps located on the underside of the sewn assembly. Recommended weight capacity of 240lbs per cushion.

Hopper

The frame is a welded assembly consisting of two 1.25" bent steel tube pieces, 0.188" steel end plates, and a bent sheet metal support bracket. The cushion features a high-density non-fire-retardant polyurethane foam cushion molded over a plywood core. This cushion assembly is then wrapped in polyester fabric. A plastic press-in fitting glide at the bottom opening of each leg features a soft PET felt cap for a non-skid surface. Rubber press-in bumpers located on the inside of each leg prevent marring while stacking. Recommended stacking limit of no more than 3 high. Recommended weight capacity of 240lbs.

Edge Profile Options

90 Degree Corner



2" Radius Corner



Allé surfaces are 3/4" thick. The corner of desks and tables default to a 2" radius, but can be optioned to a 90 degree corner with 90 trim for a cost reduction.

Edge Profile

90

90 ^ **CU**

90 Trim **CQ**

90 Trim Square Corner ^^ **CQS**

90 Ply *** **CV**

Knife

Knife ^ **CK**

Knife Trim ^ **CJ**

Knife Ply *** **CW**

Round

Round Under ^ **CE**

Round Under Ply *** **CG**

^ **MDF edge**

+\$150 per surface list upcharge

^^ **Square edge**

-\$100 per surface list deduction

*** **Ply edge**

+\$350 per surface list upcharge

+\$50 upcharge for charcoal stain

Finish Guide

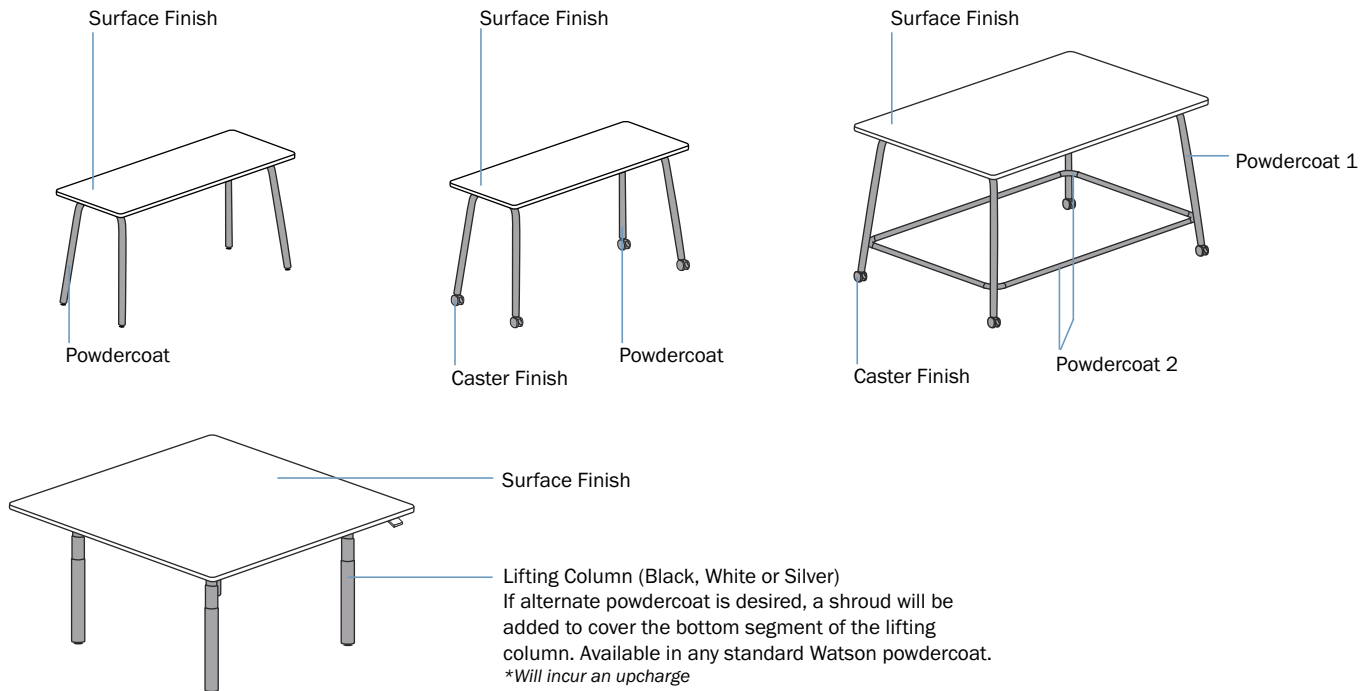

Powdercoat*

Alabaster	AB
Frosty White	FJ
Markerboard	WM
Silver	FQ
Satin Grey	WA
Slate	SG
Charcoal	CH
Black	BK
Aqua	AQU
Burnt Orange	REO
Mustard Seed	LEY
Emerald Green	PIG
Sage Green	PAG
Blue Steel	BLG
Stone	STG
Bark	BRK
Blush	BLU
Crema	CRE
Sapphire	SAP
Ruby	RBY

*Clearcoat not available with Allé Collection

Fenix Laminate

Bianco Kos	MWH
Castoro Ottawa	MBR
Nero Ingo	MBK

*Fenix NTM Laminate
Upcharges by surface size:
Under 30x72 +\$440 list each
Over 30x72 +\$880 list each

Forbo Linoleum

Forbo Ash	FAS
Forbo Pebble	FPE
Forbo Mushroom	FMU
Forbo Olive	FOL
Forbo Pewter	FPW
Forbo Noir	FNE
Forbo Smokey Blue	FSB

*Forbo Linoleum
Our super green material with a leather-like texture and matte finish.
Upcharge: +\$250 list per surface.

Surface Laminate

Alabaster	AB
Frosty White	FJ
Markerboard [§]	WM
Fashion Grey	FQ
Black	BK
Woodgrain	
White Cypress	WCS
Fawn Cypress	FCZ
Phantom Pearl	PPE
Phantom Ecru	PEC
Grey Elm	GEL
Field Elm	FLM
Loft Oak	LOA
Blond Echo	EH
Veranda Teak	VTK
Neo Walnut	NEW
Walnut Heights	WTH
Skyline Walnut	SKW
Studio Teak	DT
Ebony Recon	ERE

[§]Markerboard
+\$100 per surface
list upcharge

Extended Powdercoat Program

Additional RAL colors are available as part of Watson's Extended Powdercoat Program. Please consult with your account manager to ensure your powder selection is available. Some pearls and metallics are not offered.

- Upcharge: \$1760 list per order, per color
- Leadtime: No change to leadtime

Finish Guide

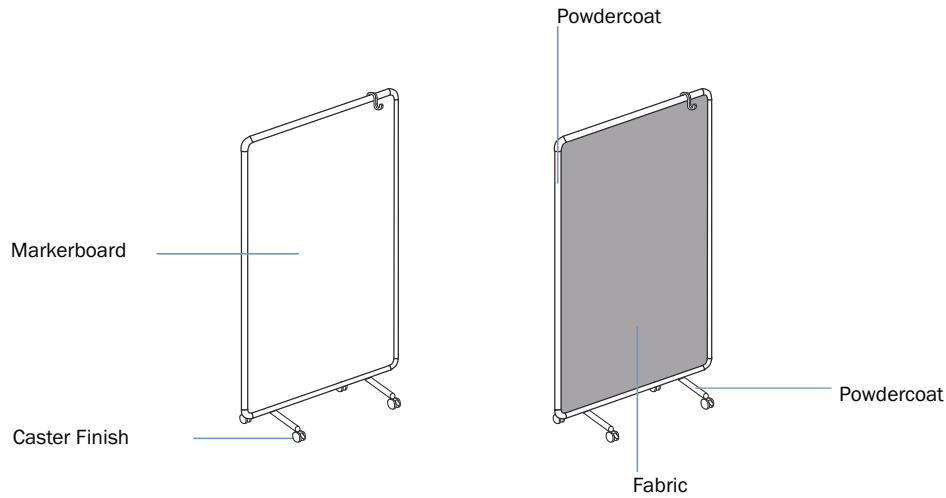

Fabric

Synergy 66*

Affix	AFI
Alike	ALK
Append	APP
Chemistry	CHE
Group	GRO
Kinship	KIN
Loop	LOO
Mutual	MUT
Pact	PAC
Serendipity	SER
Summon	SUM
Work	WOR
Rivet	
Tensile	TEN
Vitreous	VIT
Wire	WRE
Forge	FRG
Spark	SPK
Molten	MLT
Otter	OTR
Alloy	ALY
Grey Brindle	GRB
Galvanize	GLV
Lagoon	LGN
Quench	QUE

Powdercoat*

Alabaster	AB
Frosty White	FJ
Markerboard	WM
Silver	FQ
Satin Grey	WA
Slate	SG
Charcoal	CH
Black	BK
Aqua	AQU
Burnt Orange	REO
Mustard Seed	LEY
Emerald Green	PIG
Sage Green	PAG
Blue Steel	BLG
Stone	STG
Bark	BRK
Blush	BLU
Crema	CRE
Sapphire	SAP
Ruby	RBY

*Clearcoat not available with Allé Collection

Extended Powdercoat Program

Additional RAL colors are available as part of Watson's Extended Powdercoat Program. Please consult with your account manager to ensure your powder selection is available. Some pearls and metallics are not offered.

- Upcharge: \$1760 list per order, per color
- Leadtime: No change to leadtime

Caster/Coathook

White Caster / Gray Coathook	WG
Black Caster / Charcoal Coathook	BC

Finish Guide

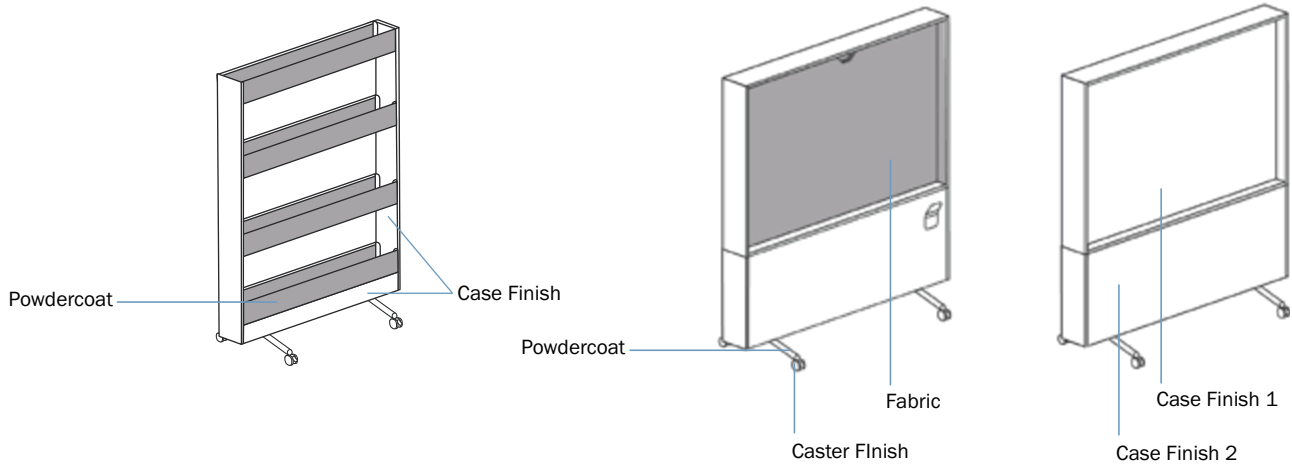

Powdercoat*

Alabaster	AB
Frosty White	FJ
Markerboard	WM
Silver	FQ
Satin Grey	WA
Slate	SG
Charcoal	CH
Black	BK
Aqua	AQU
Burnt Orange	REO
Mustard Seed	LEY
Emerald Green	PIG
Sage Green	PAG
Blue Steel	BLG
Stone	STG
Bark	BRK
Blush	BLU
Crema	CRE
Sapphire	SAP
Ruby	RBY

*Clearcoat not available with Allé Collection

Extended Powdercoat Program

Additional RAL colors are available as part of Watson's Extended Powdercoat Program. Please consult with your account manager to ensure your powder selection is available. Some pearls and metallics are not offered.

- Upcharge: \$1760 list per order, per color
- Leadtime: No change to leadtime

Fabric

Synergy 66*	
Affix	AFI
Alike	ALK
Append	APP
Chemistry	CHE
Group	GRO
Kinship	KIN
Loop	LOO
Mutual	MUT
Pact	PAC
Serendipity	SER
Summon	SUM
Work	WOR
Rivet	
Tensile	TEN
Vitreous	VIT
Wire	WRE
Forge	FRG
Spark	SPK
Molten	MLT
Otter	OTR
Alloy	ALY
Grey Brindle	GRB
Galvanize	GLV
Lagoon	LGN
Quench	QUE

Caster

White Caster	WH
Black Caster	BK

Storage Laminates

Frosty White	AB
Fashion Grey	FJ
Satin Grey	GY
Charcoal	CH
Slate	SG
Black	BK
Woodgrain	
Field Elm	FLM
Blond Echo	EH
Phantom Ecu	PEC
Fawn Cypress	FCZ
Studio Teak	DT
Walnut Heights	WTH

Finish Guide

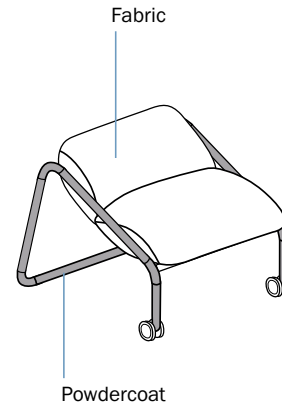
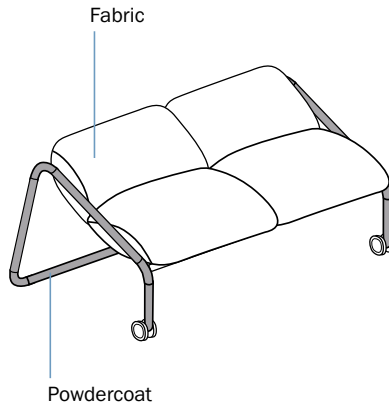
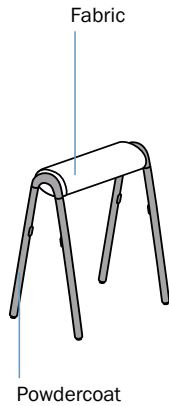

Powdercoat*

Alabaster	AB
Frosty White	FJ
Markerboard	WM
Silver	FQ
Satin Grey	WA
Slate	SG
Charcoal	CH
Black	BK
Aqua	AQU
Burnt Orange	REO
Mustard Seed	LEY
Emerald Green	PIG
Sage Green	PAG
Blue Steel	BLG
Stone	STG
Bark	BRK
Blush	BLU
Crema	CRE
Sapphire	SAP
Ruby	RBV

Fabric

Synergy 66*

Append	APP
Chemistry	CHE
Group	GRO
Serendipity	SER
Work	WOR

Rivet

Forge	FRG
Grey Brindle	GRB
Lagoon	LGN
Quench	QUE
Vitreous	VIT

*Synergy66
+\$250 list upcharge

*Clearcoat not available with Allé Collection

Extended Powdercoat Program

Additional RAL colors are available as part of Watson's Extended Powdercoat Program. Please consult with your account manager to ensure your powder selection is available. Some pearls and metallics are not offered.

- Upcharge: \$1760 list per order, per color
- Leadtime: No change to leadtime

Allé Work Desk

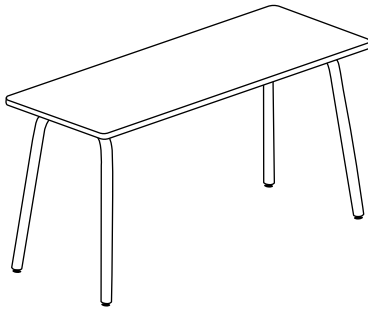

Options & Upcharges

Casters: +\$150 (Table height maintained)

Power & Tech: Grommet (+\$55 per grommet) / See pages 6 for cut out locations

Edge Profiles: 90 (+\$150) / 90 Trim / 90 Trim Square Corner (-\$100) / 90 Ply (+\$350) / Knife (+\$150) / Knife Trim (\$150) / Knife Ply (+\$350) / Round Under (+\$150) / Round Under Ply (+\$350)

D	W	H	MODEL NUMBER	PRICE
24	48	29.5	WBDW2448	750
24	54	29.5	WBDW2454	850
24	60	29.5	WBDW2460	850
24	66	29.5	WBDW2466	900
24	72	29.5	WBDW2472	900
30	48	29.5	WBDW3048	850
30	54	29.5	WBDW3054	950
30	60	29.5	WBDW3060	950
30	66	29.5	WBDW3066	1000
30	72	29.5	WBDW3072	1000

Allé Meet Table

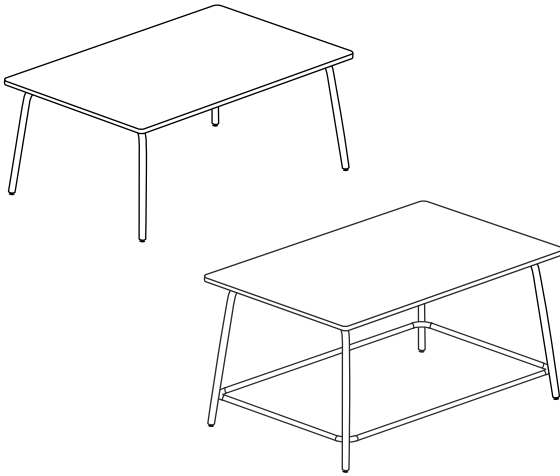

Options & Upcharges

Casters: +\$150 (Table height maintained)

Power & Tech: Grommet (+\$55 per grommet) / See page 31 for power options and pricing

Edge Profiles: 90 (+\$150) / 90 Trim / 90 Trim Square Corner (-\$100) / 90 Ply (+\$350) / Knife (+\$150) / Knife Trim (\$150) / Knife Ply (+\$350) / Round Under (+\$150) / Round Under Ply (+\$350)

Footbar: 36"H (+\$550) / 42"H (+\$600)

Notes

- 36" and 42" high tables come standard with a footbar (with upcharge)

D	W	H	MODEL NUMBER	PRICE	D	W	H	MODEL NUMBER	PRICE
30	30	29.5, 36, 42	WBTM3030	800	42	72	29.5, 36, 42	WBTM4272	1300
30	36	29.5, 36, 42	WBTM3036	800	42	78	29.5, 36, 42	WBTM4278	1350
30	42	29.5, 36, 42	WBTM3042	850	42	84	29.5, 36, 42	WBTM4284	1350
30	48	29.5, 36, 42	WBTM3048	850	42	90	29.5, 36, 42	WBTM4290	1400
30	54	29.5, 36, 42	WBTM3054	950	42	96	29.5, 36, 42	WBTM4296	1400
30	60	29.5, 36, 42	WBTM3060	950					
30	66	29.5, 36, 42	WBTM3066	1000	48	48	29.5, 36, 42	WBTM4848	1000
30	72	29.5, 36, 42	WBTM3072	1000	48	54	29.5, 36, 42	WBTM4854	1300
30	78	29.5, 36, 42	WBTM3078	1300	48	60	29.5, 36, 42	WBTM4860	1300
30	84	29.5, 36, 42	WBTM3084	1300	48	66	29.5, 36, 42	WBTM4866	1300
30	90	29.5, 36, 42	WBTM3090	1300	48	72	29.5, 36, 42	WBTM4872	1300
30	96	29.5, 36, 42	WBTM3096	1350	48	78	29.5, 36, 42	WBTM4878	1350
					48	84	29.5, 36, 42	WBTM4884	1400
36	36	29.5, 36, 42	WBTM3636	950	48	90	29.5, 36, 42	WBTM4890	1400
36	42	29.5, 36, 42	WBTM3642	1000	48	96	29.5, 36, 42	WBTM4896	1400
36	48	29.5, 36, 42	WBTM3648	1000					
36	54	29.5, 36, 42	WBTM3654	1250	54	54	29.5, 36, 42	WBTM5454	1300
36	60	29.5, 36, 42	WBTM3660	1250	54	60	29.5, 36, 42	WBTM5460	1300
36	66	29.5, 36, 42	WBTM3666	1300	54	66	29.5, 36, 42	WBTM5466	1250
36	72	29.5, 36, 42	WBTM3672	1300	54	72	29.5, 36, 42	WBTM5472	1350
36	78	29.5, 36, 42	WBTM3678	1350	54	78	29.5, 36, 42	WBTM5478	1400
36	84	29.5, 36, 42	WBTM3684	1350					
36	90	29.5, 36, 42	WBTM3690	1400	60	60	29.5, 36, 42	WBTM6060	1350
36	96	29.5, 36, 42	WBTM3696	1400	60	66	29.5, 36, 42	WBTM6066	1350
					60	72	29.5, 36, 42	WBTM6072	1400
42	42	29.5, 36, 42	WBTM4242	1000	60	78	29.5, 36, 42	WBTM6078	1400
42	48	29.5, 36, 42	WBTM4248	1000					
42	54	29.5, 36, 42	WBTM4254	1250					
42	60	29.5, 36, 42	WBTM4260	1300					
42	66	29.5, 36, 42	WBTM4266	1300					

Allé Meet-Up Table

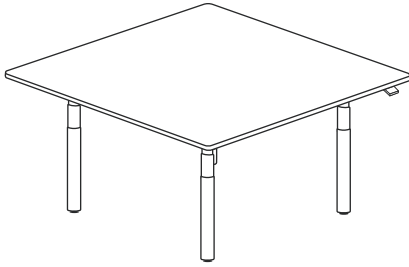

Options & Upcharges

Switch: Embedded Two-Button / Paddle (+\$140) / Paddle with Display (+\$260)

Power & Tech: See pages 31 for power options and pricing

Edge Profiles: 90 (+\$150) / 90 Trim / 90 Trim Square Corner (-\$100) / 90 Ply (+\$350) / Knife (+\$150) / Knife Trim (\$150) / Knife Ply (+\$350) / Round Under (+\$150) / Round Under Ply (+\$350)

Notes

- Lifting columns comes standard in silver, black or white powdercoat. All other Watson powdercoats include a steel shroud (+\$330)

D	W	MODEL NUMBER	PRICE
60	60	WBMS6060	3200
60	72	WBMS6072	3250
60	78	WBMS6078	3750
60	84	WBMS6084	3800
60	96	WBMS6096	3850

Allé Mobile Planter

3 tier, 4 tier

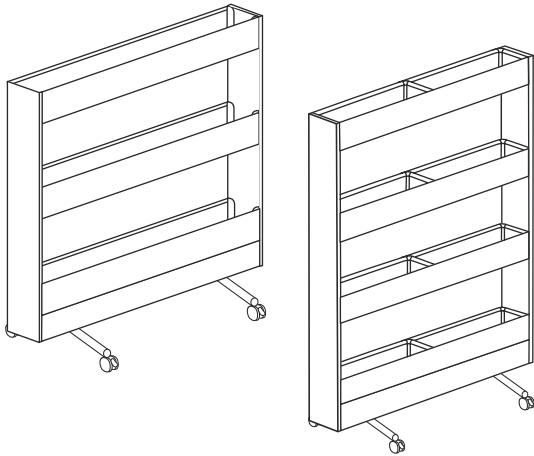

* Shown with planter tray

Options & Upcharges

Caster: Black/White

Notes:

- Three tier planter can accommodate 6 planter trays, sold individually (+\$100 each / 6 for +\$575)
- Four tier planter can accommodate 8 planter trays, sold individually (+\$100 each / 8 for +\$750)

D	W	H	MODEL NUMBER	PRICE
24	55	52	WBP5552	1400
24	55	72	WBP5572	1600

Allé Mobile Planter Tray

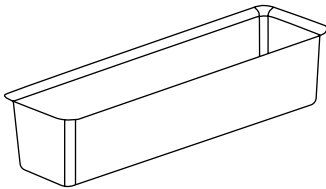

D	W	H	MODEL NUMBER	PRICE
8	27	5	WBP2705	100

Allé Mobile Monitor Wall

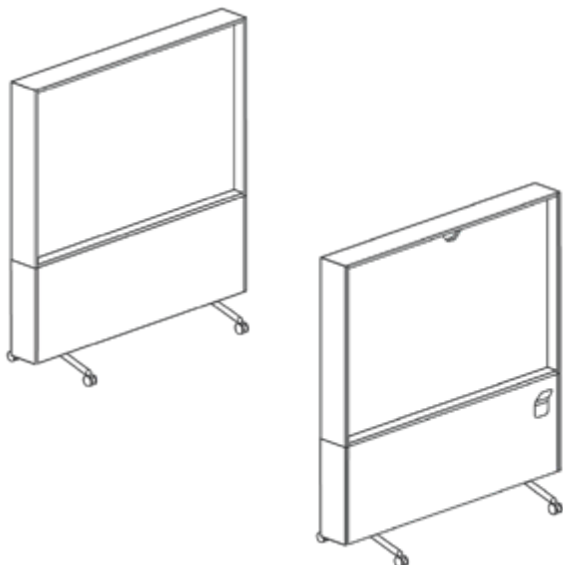

Options & Upcharges

Caster: Black / White

Power & Tech: Convenience power with utility and 108" plug-in infeed (+625)

Notes

- 56" W for up to 55" monitor
- 68" W for up to 65" monitor

D	W	H	MODEL NUMBER	PRICE
24	56	72	WBM5672	2650
24	68	72	WBM6872	2900

Allé Mobile Pin Board

Matching tackable fabric, both sides

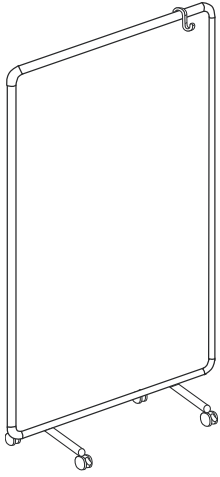

Options & Upcharges

Caster and Coathook: White Caster / Gray PET Coathook or
Black Caster /Charcoal PET Coathook

D	W	H	MODEL NUMBER	PRICE
16.5	48	72	WBWF4872	1550

Allé Mobile Write Board

Markerboard, both sides

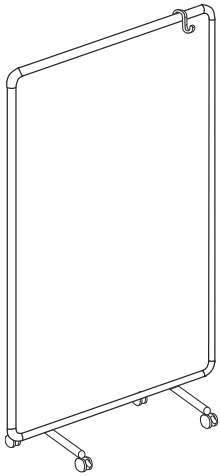

Options & Upcharges

Caster and Coathook: White Caster / Gray PET Coathook or
Black Caster /Charcoal PET Coathook

D	W	H	MODEL NUMBER	PRICE
16.5	48	72	WBWM4872	1300

Allé Hopper

D	W	H	MODEL NUMBER	PRICE
16	22	28	WBH1622	600

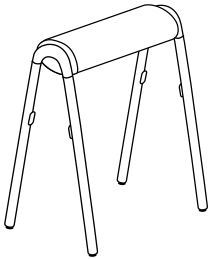

Allé Sofa

Single

Options & Upcharges

Fabrics: Select Rivet fabrics / Select Synergy66 fabrics (+\$250)

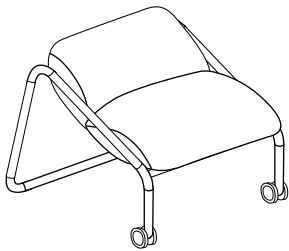

D	W	MODEL NUMBER	PRICE
40	36	WBSS4036	1625

Allé Sofa

Double

Options & Upcharges

Fabrics: Select Rivet fabrics / Select Synergy66 fabrics (+\$500)

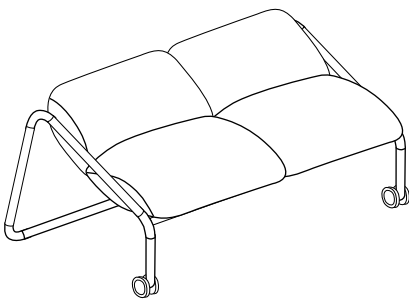

D	W	MODEL NUMBER	PRICE
40	36	WBSD4036	2050

Cable Tray

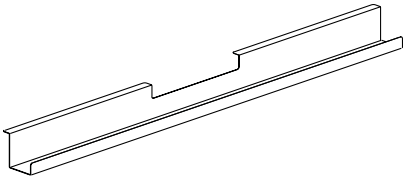

Notes

- Reference specified table/desk width column below to determine which cable tray you need. Recommended undersizing of 12" (6" on each side).

SPECIFIED TABLE/ DESK WIDTH	ACTUAL WIDTH	MODEL NUMBER	PRICE
18	15	WAWH27	120
24	21	WAWH33	130
30	27	WAWH39	130
36	33	WAWH45	130
42	39	WAWH51	150
48	45	WAWH57	150
54	51	WAWH63	170
60	57	WAWH69	170
66	63	WAWH75	170
72	69	WAWH81	190
78	75	WAWH87	190

Utility Power Strip

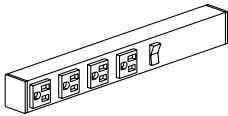

Notes

- Utility power strip attaches to the cable tray

MODEL NUMBER	PRICE
C9AUP	280

Vertical Cable Channel

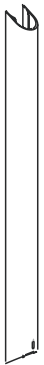

Notes

- Height indicates the height of the table specified, actual product height is less
- 29H works with 29.5"H Work desk and meet table. 36H works with 36"H Meet Table and 42H works with 42"H Meet table. All solutions work for the stated size with casters or glides

	H	MODEL NUMBER	PRICE
Fixed	29	WVCM29	150
Fixed	36	WVCM36	150
Fixed	42	WVCM42	150

Watson Height Adjustable Cable Manager



W	MODEL NUMBER	PRICE
0	XXX	350

Cable Sleeve

Fabric

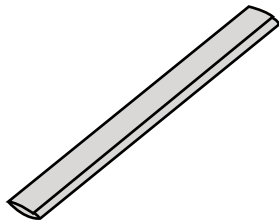

W	MODEL NUMBER	PRICE
43	WACMF43	210

Cable Clips

Set of Five

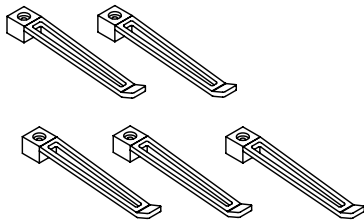

Notes

- Desks com with 4 cable clips at the narrowest width and increase incrementally as the desk size grows.
- A set number of cable clips comes standard with work desk and meet tables based on product width. Additional cable clips are available, sold in a set of 5.

MODEL NUMBER	PRICE
DAAS	60

Monitor Mount

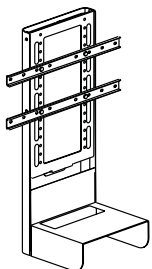

Options & Upcharges

Power & Tech: Integrated convenience power (4 outlets total) +\$275

	H	MODEL NUMBER	PRICE
Fixed	17	FLAV	1030

In- Surface Dual-Hinge Power Units

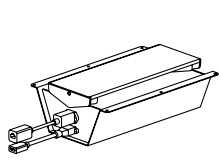

Single Unit

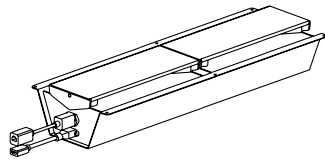

Double Unit: XL

POWER/DATA	MODEL NUMBER	PRICE
Full Power Plug-In Infeed: 3 pwr, USB A+C, 1 HDMI, 1 CAT6 / 144" cord	WACMF43	1500
Full Power Hardwire Infeed: 3 pwr, USB A+C, 1 HDMI, 1 CAT6 / 120" cord	WATC	1540
Basic Power Plug-In Infeed: Power Strip 4 pwr, 1 HDMI, 1 CAT6 / 120" cord	WATS	1210
Open: 1 HDMI, 1 CAT6	WATO	1050
XL Full Power Plug-In Infeed: 6 pwr, 2 USB A+C, 1 HDMI, 1 CAT6 / 144" cord	WATXLF	2590
XL Full Power Hardwire Infeed: 6 pwr, 2 USB A+C, 1 HDMI, 1 CAT6 / 120" cord	WATXLC	2590
XL Open: 1 HDMI, 1 CAT6	WATXLO	1540

Byrne E2X Drop-In Power Units

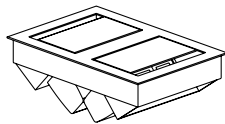

E2X - 3-port per side

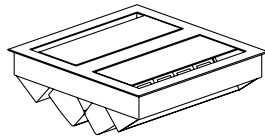

E2X - 5-port per side

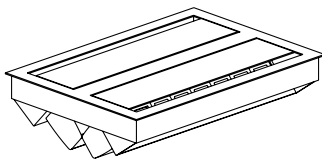

E2X - 8-port per side

Options & Upcharges

Power Connection Options: Plug-in / Hardwire (+\$200) / Chicago

Notes

- All Byrne drop-in power units require surface cutout (+\$55)
- Finishes: Silver/Black, Silver/White, no upcharge. Black/Black (+\$420)

POWER/DATA	MODEL NUMBER	PRICE
3-port per side: 2 PWR, 1 USB A+C per side	WPAE2X2P1D	1460
3-port per side: 2 PWR, 1 Open per side	WPAE2X2P10	1165
5-port per side: 3 PWR, 1 USB A+C, 1 Open per side	WPAE2X3P1D10	1565
5-port per side: 3 PWR, 2 Open per side	WPAE2X3P20	1280
8-port per side: 5 PWR, 1 USB A+C, 2 Open per side	WPAE2X5P1D20	1945
8-port: 5 PWR, 3 Open per side	WPAE2X5P30	1650

Byrne Ellora Drop-In Power Units

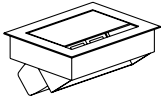

Ellora - 3-port

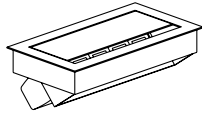

Ellora - 5-port

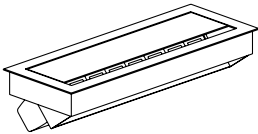

Ellora - 8-port

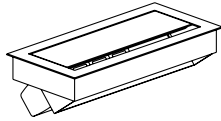

Ellora Qi

Options & Upcharges

Power Connection Options: Plug-in / Hardwire (+\$100) / Chicago

Notes

- All Byrne drop-in power units require surface cutout (+\$55)
- Finishes: Silver/Black, Silver/White, no upcharge. Black/Black (+\$120)
- Units with Qi Charging require \$150 upcharge for Black

POWER/DATA	MODEL NUMBER	PRICE
3-port: 2 PWR, 1 Open	WPAE2P10	685
5-port: 3 PWR, 1 USB A+C, 1 Open	WPAE3P1D10	850
5-port per side: 3 PWR, 1 USB A+C, 1 Open per side	WPAE2X3P1D10	1565
5-port per side: 3 PWR, 2 Open per side	WPAE2X3P20	1280
8-port per side: 5 PWR, 1 USB A+C, 2 Open per side	WPAE2X5P1D20	1945
8-port: 5 PWR, 3 Open per side	WPAE2X5P30	1650

Byrne MhoB Drop-In Power Units

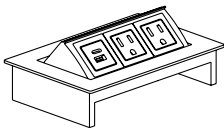

MhoB 3 Port

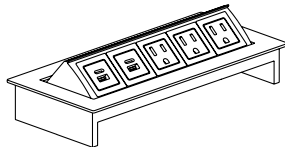

MhoB 5 Port

Options & Upcharges

Power Connection Options: Plug-in / Hardwire (+\$100) / Chicago
Finish: Black/Black (+\$120)

Notes

- All Byrne drop-in power units require surface cutout (+\$55)

POWER/DATA	MODEL NUMBER	PRICE
3-port: 2 PWR, 1 Open	WPAM2P10	495
3-port: 2 PWR, 1 USB A+C	WPAM2P1D	610
5-port: 3 PWR, 2 Open	WPAM3P20	525
5-port: 3 PWR, 2 USB A+C	WPAM3P2D	800