

# TIA

## Spec Guide & Price List

Height-adjustable Private Office + Team + Conference



## **TIA SPEC GUIDE**

Statement of Line.....	3
Tia Office.....	7
Tia Team + Conference.....	13
Finish Guide.....	21

## **TIA PRICE LIST**

Tia Office.....	22
Tia Team Tables.....	33
Tia Conference.....	35

*Prices effective January 2025*

---

*For payment, shipping, and warranty information,  
please see our [Terms & Conditions](#).*

## Tia Statement of Line

### Run-off Desk

*Height-adjustable with  
Drawer Support Credenza*

**Desk Depth:** 30, 36  
**Desk Width:** 60, 72, 84, 96  
**Storage Depth:** 20  
**Storage Width:** 60, 72, 84, 96  
**Desk Height:** 28 - 47.5

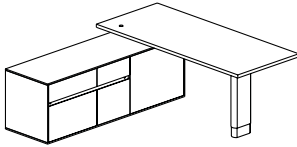

*Fixed-height with  
Drawer Support Credenza*

**Desk Depth:** 30, 36  
**Desk Width:** 60, 72, 84, 96  
**Storage Depth:** 20  
**Storage Width:** 60, 72, 84, 96  
**Desk Height:** 29

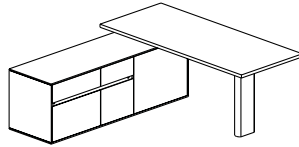

*Modesty Shield*

**Desk Width:** 60, 72, 84, 96

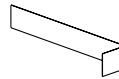

*Clamp On Monitor  
Mount*



*Height-adjustable with  
Combo Support Credenza*

**Desk Depth:** 30, 36  
**Desk Width:** 60, 72, 84, 96  
**Storage Depth:** 20  
**Storage Width:** 72, 84, 96  
**Desk Height:** 28 - 47.5

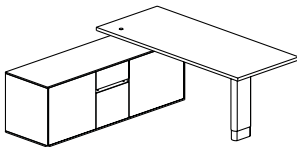

*Fixed-height with  
Combo Support Credenza*

**Desk Depth:** 30, 36  
**Desk Width:** 60, 72, 84, 96  
**Storage Depth:** 20  
**Storage Width:** 72, 84, 96  
**Desk Height:** 29

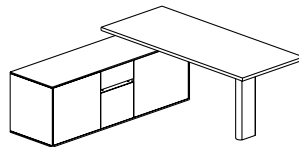

*Run Off Desk Storage  
Back Panel*

**Desk Width:** 60, 72, 84  
**Desk Height:** 24  
**Table Depth:** 30, 36

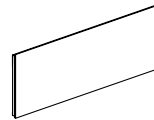

### Freestanding Credenza

*Drawer Storage*

**D:** 20  
**W:** 60, 72, 84  
**H:** 24

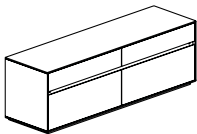

*Combo Storage*

**D:** 20  
**W:** 60, 72, 84  
**H:** 24

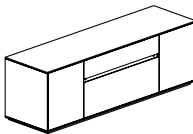

*Door Storage*

**D:** 20  
**W:** 60, 72, 84  
**H:** 24

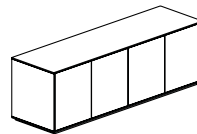

*Freestanding Storage  
Back Panel*

**W:** 60, 72, 84  
**H:** 24

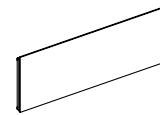

### Secondary Stacking Storage

*15" Door (pair)*

**D:** 14  
**W:** 30  
**H:** 48, 60, 72

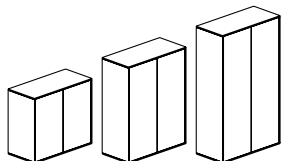

*15" Open / 15" Door*

**D:** 14  
**W:** 30  
**H:** 48, 60, 72

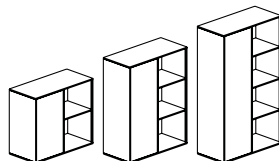

*24" Open / 15" Door*

**D:** 14  
**W:** 39  
**H:** 48, 60, 72

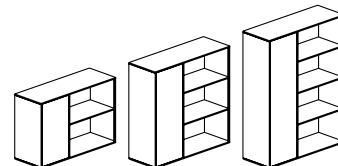

---

## Tia Statement of Line

### Secondary Storage w/ Locker

15" Locker / 15" Door

**D:** 14  
**W:** 30  
**H:** 48, 60, 72

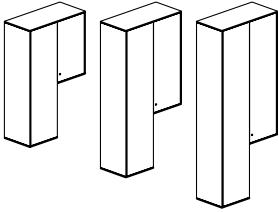

15" Open / 15" Locker

**D:** 14  
**W:** 30  
**H:** 48, 60, 72

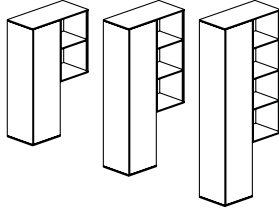

24" Open / 15" Locker

**D:** 14  
**W:** 39  
**H:** 48, 60, 72

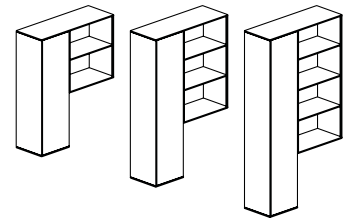

15" Open / 15" Door / 15" Locker

**D:** 14  
**W:** 45  
**H:** 48, 60, 72

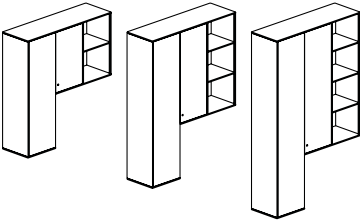

24" Open / 15" Door / 15" Locker

**D:** 14  
**W:** 54  
**H:** 48, 60, 72

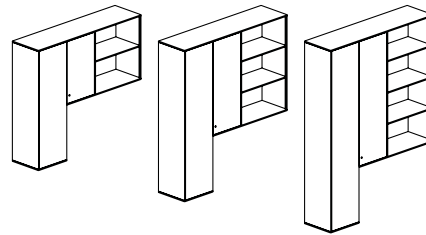

### Secondary Storage w/ Wardrobe

15" Door / 24" Wardrobe

**D:** 14  
**W:** 39  
**H:** 48, 60, 72

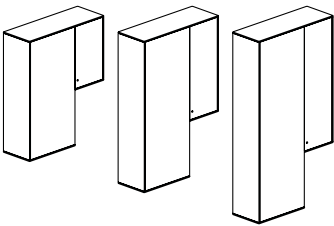

15" Open / 24" Wardrobe

**D:** 14  
**W:** 39  
**H:** 48, 60, 72

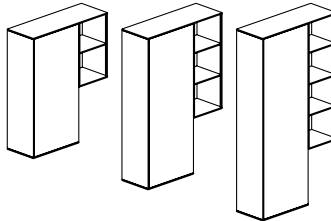

24" Open / 24" Wardrobe

**D:** 14  
**W:** 48  
**H:** 48, 60, 72

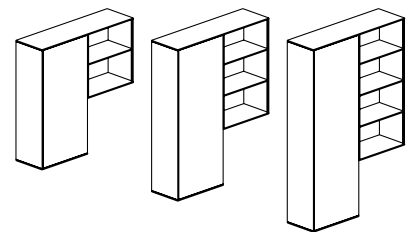

15" Open / 15" Door / 24" Wardrobe

**D:** 14  
**W:** 54  
**H:** 48, 60, 72

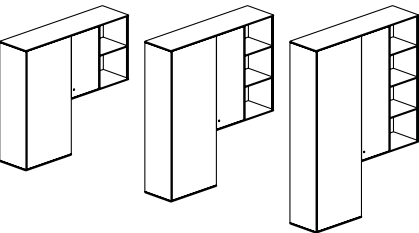

24" Open / 15" Door / 24" Wardrobe

**D:** 14  
**W:** 63  
**H:** 48, 60, 72

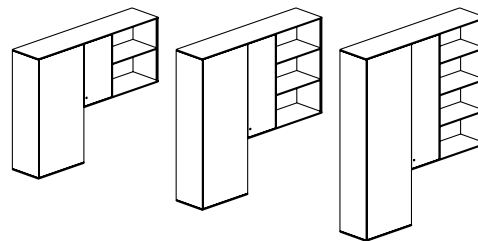

---

## Tia Statement of Line

### Team Table w/ Tech Cabinet

*Rectangle, Height-adjustable*

**D:** 48

**W:** 60, 72, 84, 96

**H:** 28 - 47.5

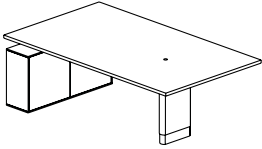

*Rectangle, Fixed-height*

**D:** 48

**W:** 60, 72, 84, 96

**H:** 29.5

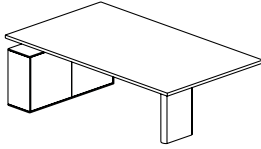

*Tech Cabinet Back Panel*



*Monitor Mount*



*Super Ellipse, Height-adjustable*

**D:** 48

**W:** 60, 72, 84, 96

**H:** 28 - 47.5

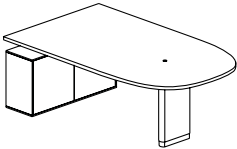

*Super Ellipse, Fixed-Height*

**D:** 48

**W:** 60, 72, 84, 96

**H:** 29.5

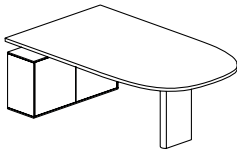

*Tapered, Height-adjustable*

**D:** 54 - 48

**W:** 60, 72, 84, 96

**H:** 28 - 47.5

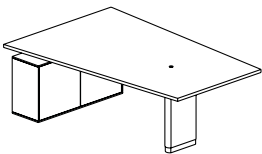

*Tapered, Fixed-height*

**D:** 54 - 48

**W:** 60, 72, 84, 96

**H:** 29.5

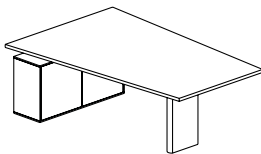

---

## Tia Statement of Line

### Conference Table

*Rectangle, Height-adjustable*

**D:** 42, 48, 54, 60

**W:** 84 - 144

**H:** 28 - 47.5

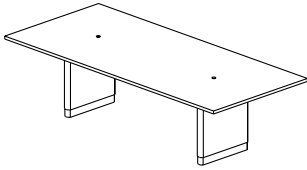

*Rectangle, Fixed-height*

**D:** 42, 48, 54, 60

**W:** 84 - 144

**H:** 29.5

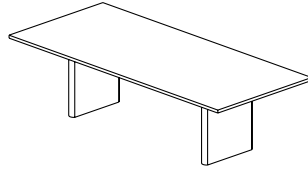

*Boat, Height-adjustable*

**D:** 60

**W:** 84 - 144

**H:** 28 - 47.5

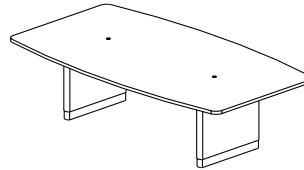

*Boat, Fixed-height*

**D:** 60

**W:** 84 - 144

**H:** 29.5

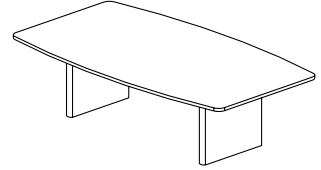

*Super Ellipse, Height-adjustable*

**D:** 48, 54, 60

**W:** 84 - 144

**H:** 28 - 47.5

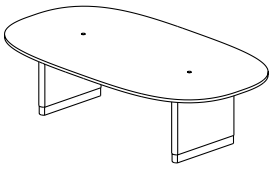

*Super Ellipse, Fixed-height*

**D:** 48, 54, 60

**W:** 84 - 144

**H:** 29.5

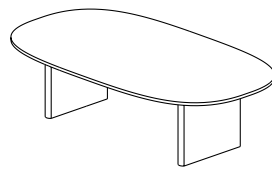

*Tapered, Height-adjustable*

**D:** 60 - 48

**W:** 84 - 144

**H:** 28 - 47.5

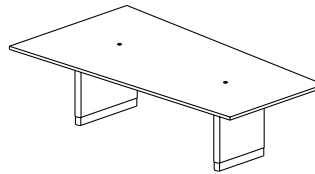

*Tapered, Fixed-height*

**D:** 60 - 48

**W:** 84 - 144

**H:** 29.5

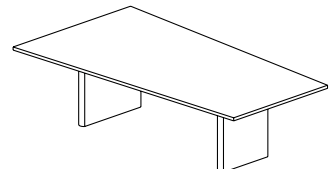

*Sideboard Credenza*

**D:** 20

**W:** 60, 72, 84

**H:** 36

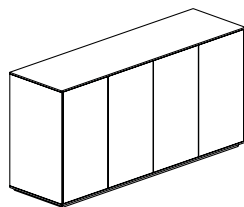

*Sideboard Back Panel*

**W:** 60, 72, 84

**H:** 36

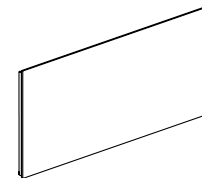

*Cable Bridge*

**W:** 84 - 144

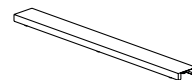

## Tia Office

### Edge Options

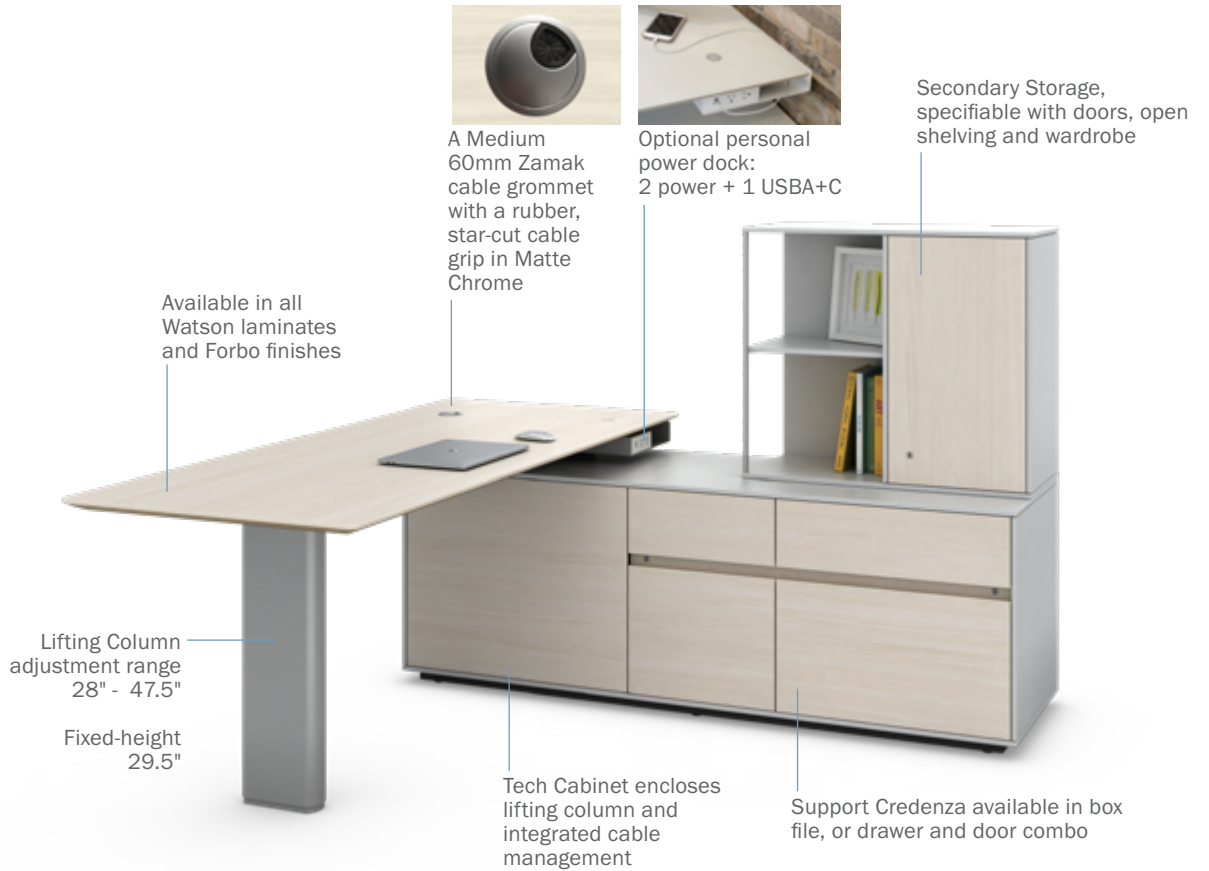
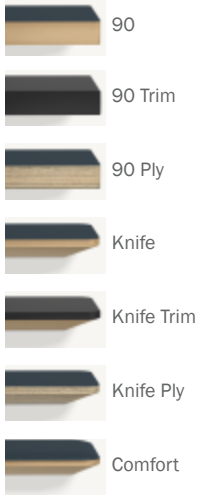

### Tab Pull

Tab pulls are a streamlined, timeless hardware solution and are available in black and silver.



### Cove Pull

Cove pulls are integrated into the face of the drawer, reducing visual clutter for a clean look.



# Tia Office Specifications

## Run-Off Desk Size Logic

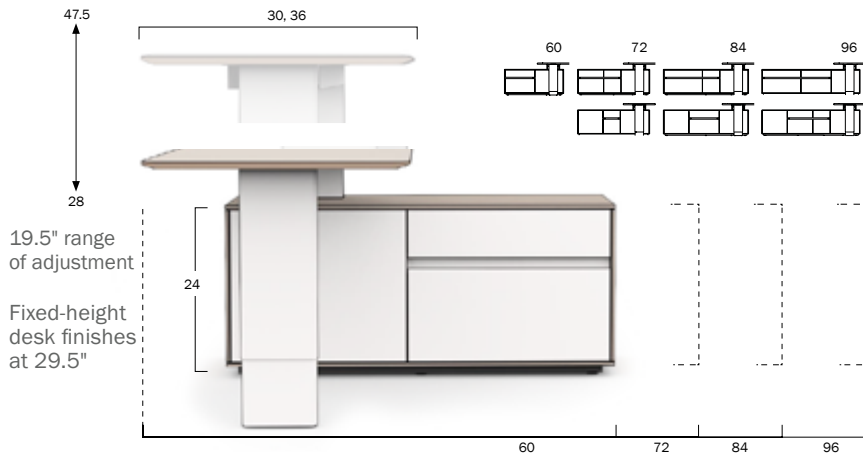

## Optional Removable Back Panel

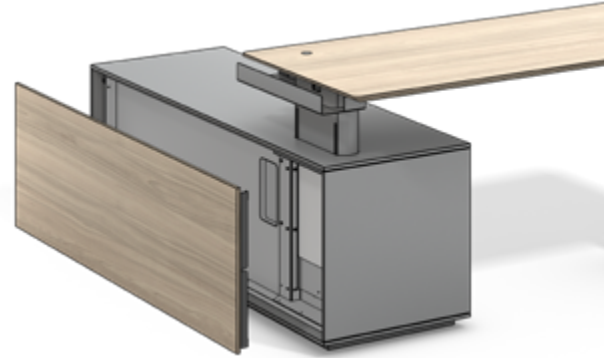

## Recessed Back Storage

All credenza and secondary storage have recessed backs to allow room for plug heads and storage to sit flush against wall

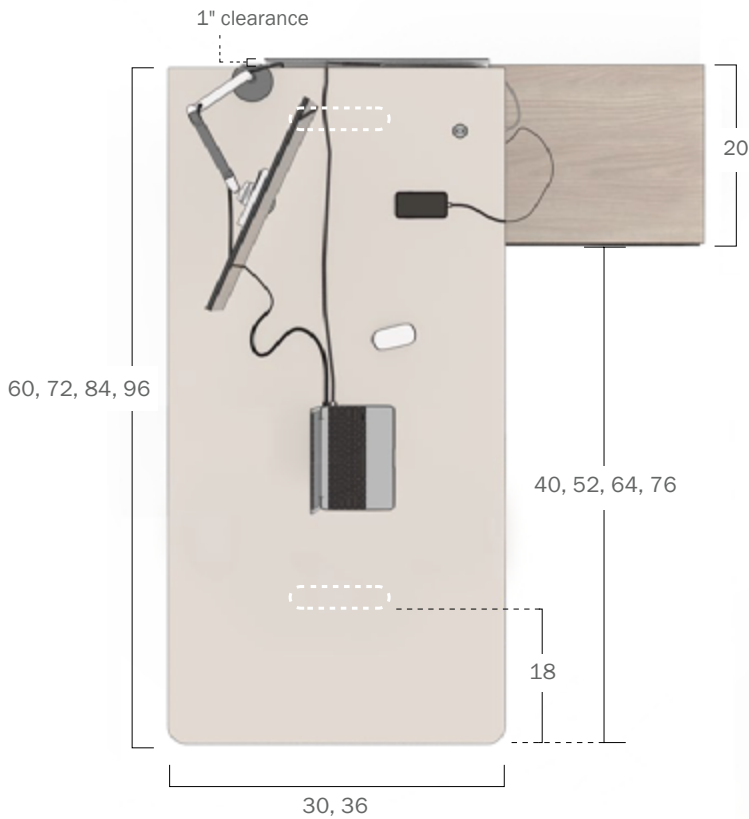

## Run-Off Desk Modesty

The Tia modesty panel wraps beneath the worksurface around the outer leg. It is formed in sheet steel and can be powdercoated or covered in Forbo linoleum made from sawdust, linseed oil, and pine rosin.

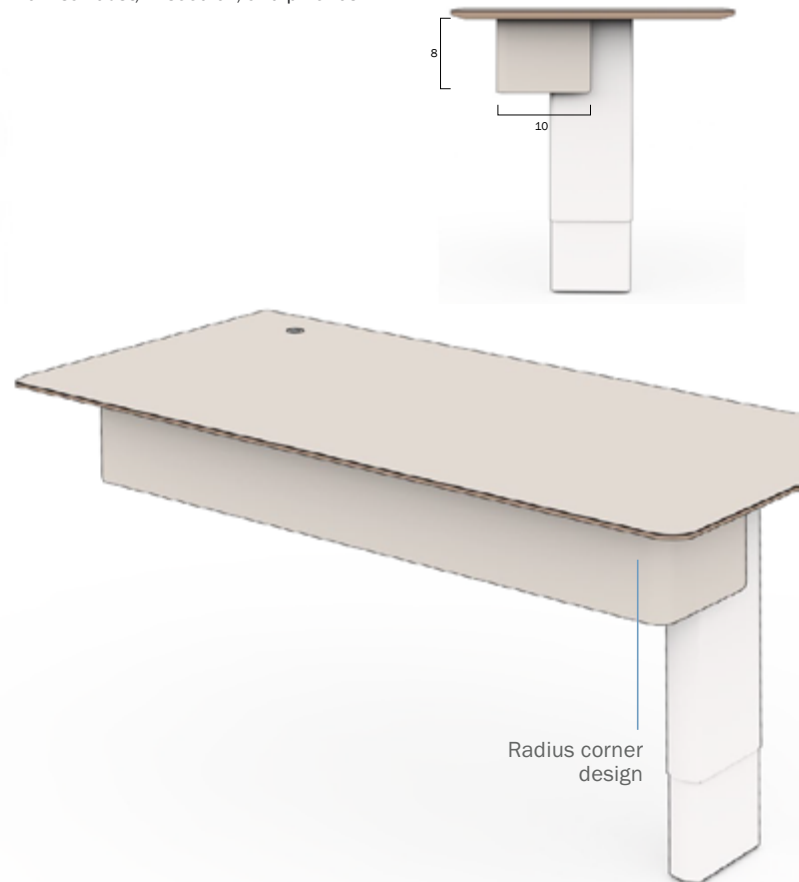



## Tia Office Power & Cable Management

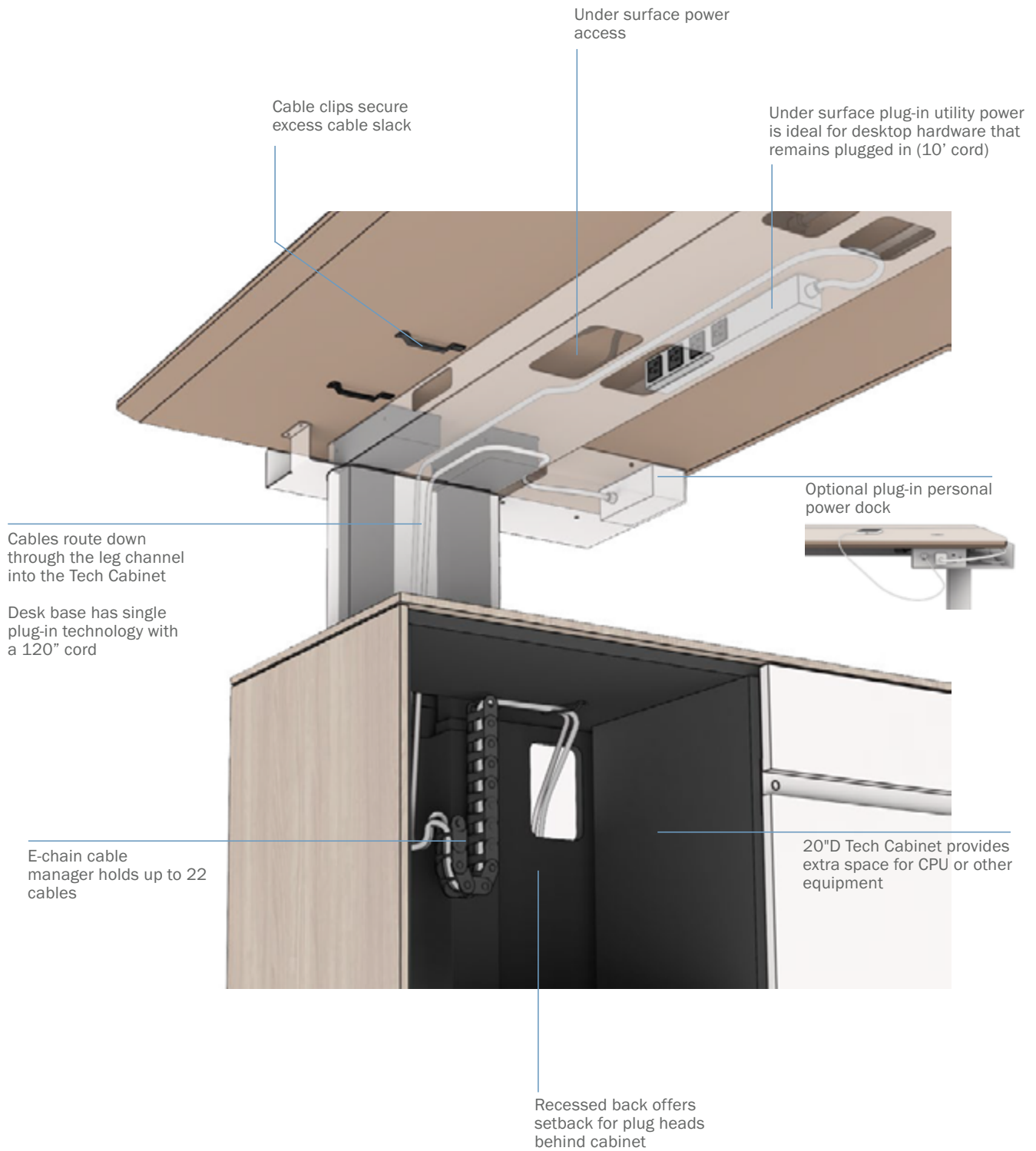

## Tia Office Storage

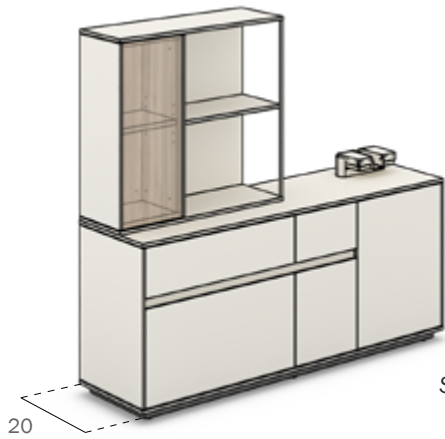

Stacker

All Tia storage sits on a black, 1-1/8" plinth base. Together with the cladding, the plinth further lightens the feel of the storage and creates a very clean aesthetic.

Tia's open shelving uses a 1/2" cladding and 1/2" steel rod support, making it sturdy despite its thin appearance.

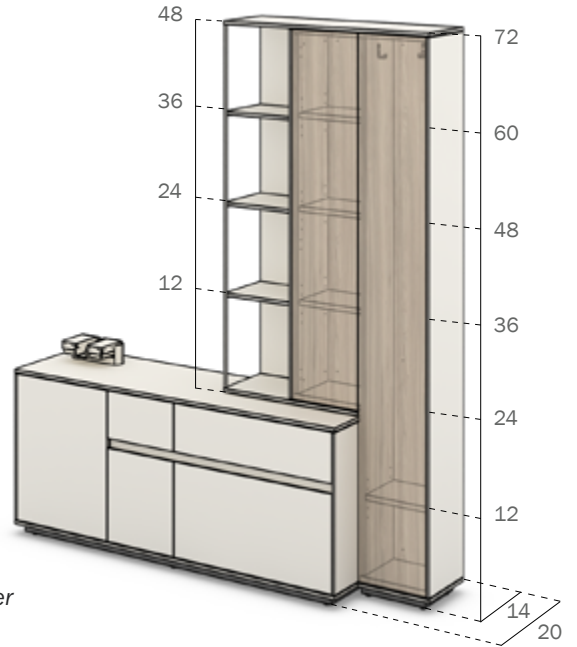

Locker

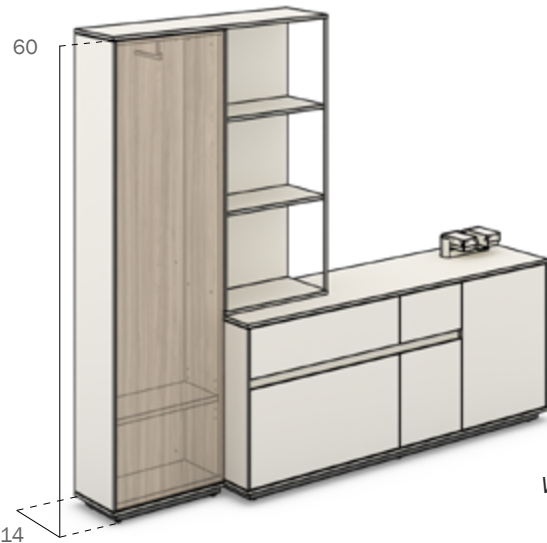

Wardrobe

Secondary storage units are bracketed to the Tia Office credenza, and come in three storage styles. Doors are available with Tab Pulls or touch-latch Cove Pulls.

### Secondary Storage

Stacker

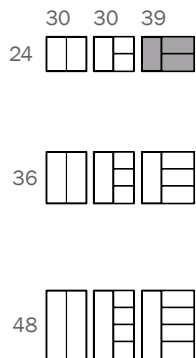

Wardrobe

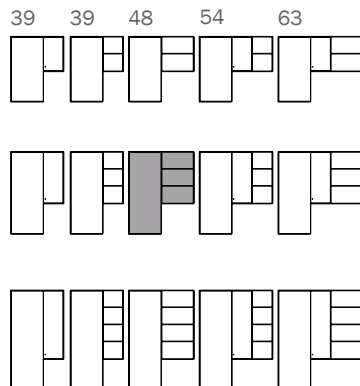

Locker

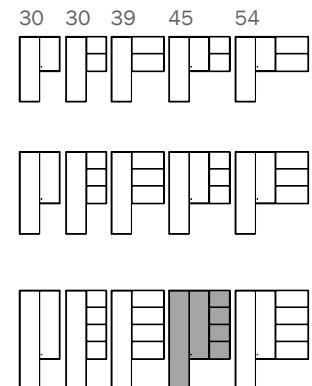

## Tia Office Storage Freestanding Credenzas

### Door

Dimensions  
Shelf dimensions

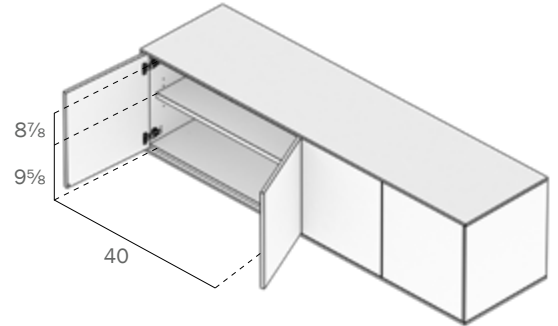
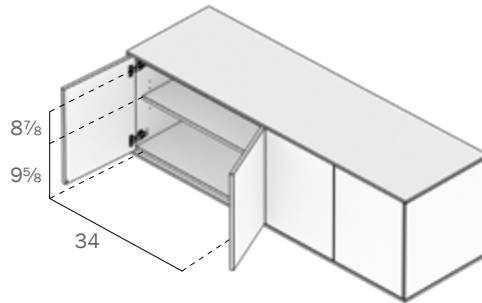
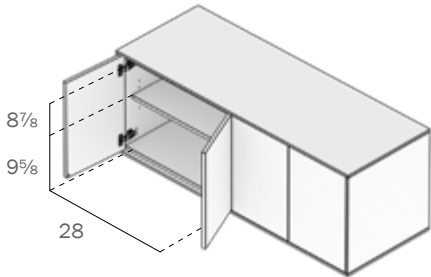
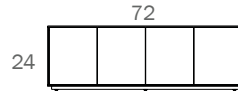
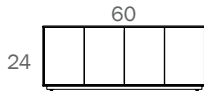

### Drawer

Dimensions  
Filing dimensions

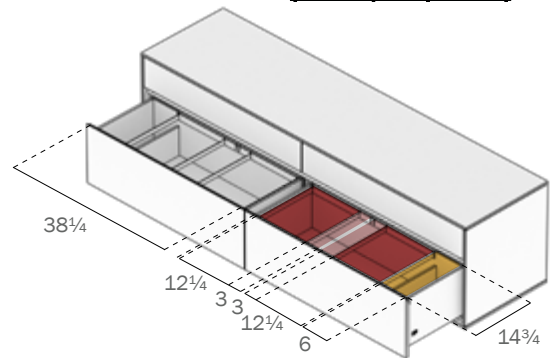
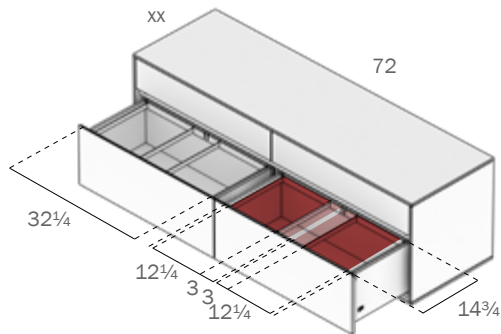
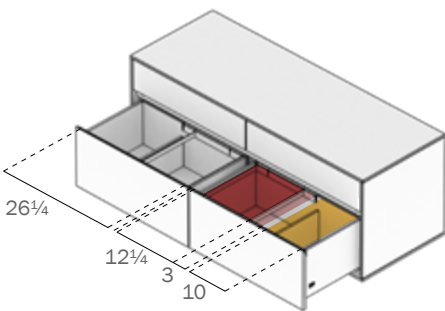
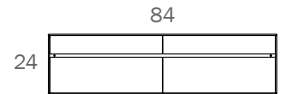
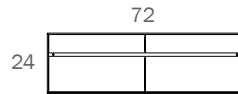
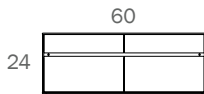

### Combo

Dimensions  
Filing dimensions

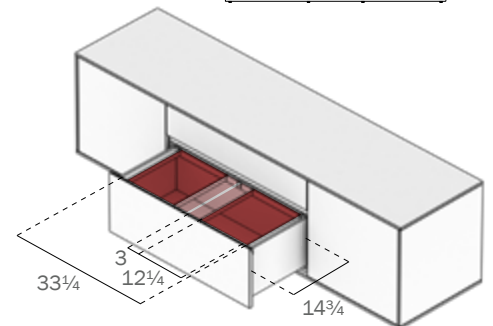
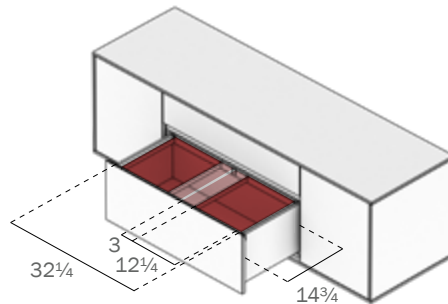
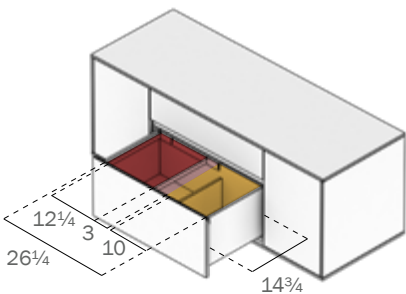
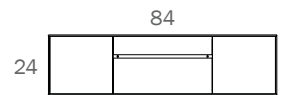



### Filing Capacities in Drawered Credenzas

- Drawers under 24"W accommodate front to back letter filing
- Drawers 24" - 36"W accommodate front to back letter or legal filing
- Drawers over 36"W accommodate two rows of front to back letter or legal filing, or a combination of both letter and legal

### Recessed Back Storage

All credenza and secondary storage have recessed backs to allow room for plug heads and storage to sit flush against wall

### Color Key

-  Front-to-back letter filing
-  Expansion for legal filing
-  Reserve storage space

---

## Tia Office | Product Specification Details

### Desk Storage

The Tia desk storage cabinet shell, face and internal partitions are constructed of 3/4" thick laminated industrial grade NAF particleboard finished with color matched 1.5mm polypropylene edge banding. The storage top and plinth panels are made from 1-1/8" thick laminate industrial grade NAF particleboard finished with color matched 1.5mm polypropylene edge banding. The cabinet shell and internal partitions are charcoal. The storage cladding material is 1/2" thick laminated industrial grade NAF particleboard finished with color matched 1.5mm polypropylene edge banding. The flush drawer pulls are achieved using an anodized aluminum extrusion mounted to the back side of the drawer face. All drawers are constructed from 1/2" thick laminated industrial grade NAF particleboard finished with color matched 1.5mm polypropylene and supported by undermount drawer slides with integrated soft-close mechanisms. Tab pulls are made from anodized aluminum and have subtly rounded edges and corners to prevent damage to adjacent objects. The leg clamp bracketry is made from 12-gauge cold rolled steel welded and powdered for maximum durability. The lifting mechanisms are provided by Linak and securely clamped in place to provide maximum worksurface stability. Cable management internal to the cabinet is provided by an injection molded plastic energy chain ensuring enough cable length is present in the height adjustable desk. The leg shroud is constructed from 22-gauge cold rolled steel formed with a subtle D shape.

### Desk Surface

The Tia desk worksurface tops are made from either 1-1/8" M2 industrial NAF particleboard or 27mm double refined NAF MDF finished with high pressure laminate or Forbo furniture linoleum and a waterborn edge stain or 1.5mm polypropylene edge banding. The Forbo surface can have a softened waterfall edge achieved using a fused laminated NAF MDF core that is profiled and sanded prior to having the linoleum vacuum press applied. All connections are made using a robust #10-1" wood screw.

### Secondary Storage

The Tia Secondary storage cabinet shell, face and internal partitions are constructed of 3/4" thick laminated industrial grade NAF particleboard finished with color matched 1.5mm polypropylene edge banding. The storage plinth panel is made from 1-1/8" thick laminate industrial grade NAF particleboard finished with color matched 1.5mm polypropylene edge banding. The cabinet shell and internal partitions are charcoal. The storage cladding material is 1/2" thick laminated industrial grade NAF particleboard finished with color matched 1.5mm polypropylene edge banding. If the unit has open display shelves these are constructed using 1/2" thick material also, the outer corner of the shelves is supported using 1/2" square hot formed steel rod. The cabinet doors are either supplied with an anodized aluminum pull or touch release door hardware. The units are designed to integrate with other Tia storage units and come with 12-gauge powder coated cold rolled steel mounting bracket required for stability.

### Freestanding Storage

The Tia freestanding storage cabinet shell, face and internal partitions are constructed of 3/4" thick laminated industrial grade NAF particleboard finished with color matched 1.5mm polypropylene edge banding. The storage top and plinth panels are made from 1-1/8" thick laminate industrial grade NAF particleboard finished with color matched 1.5mm polypropylene edge banding. The cabinet shell and internal partitions are charcoal. The storage cladding material is 1/2" thick laminated industrial grade NAF particleboard finished with color matched 1.5mm polypropylene edge banding. The flush drawer pulls are achieved using an anodized aluminum extrusion mounted to the back side of the drawer face. All drawers are constructed from 1/2" thick laminated industrial grade NAF particleboard finished with color matched 1.5mm polypropylene and supported by undermount drawer slides with integrated soft-close mechanisms. Tab pulls are made from anodized aluminum and have subtly rounded edges and corners to prevent damage to adjacent objects.

# Tia Team Tables

## Edge Options



## Team Power & Cable Management

Integrated cable channel routes monitor cables down through leg

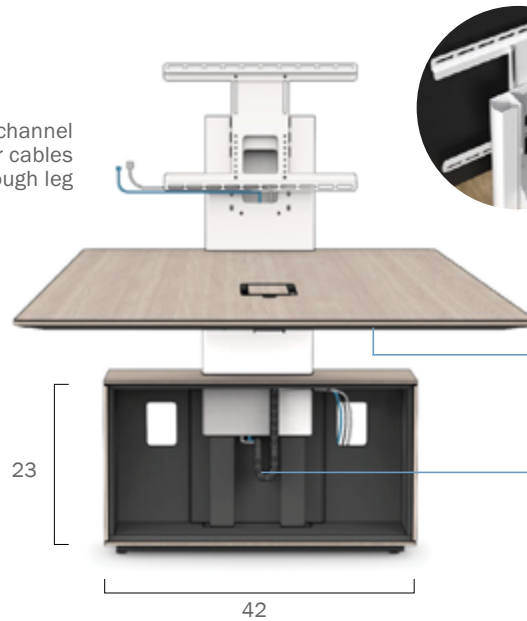

Universal monitor mount clamps to tables .75" - 1.25" thick



Under surface utility power and cable management accessible from beneath the surface

Cables for lifting columns and power/data are routed through a high capacity E-chain in the Tech Cabinet (Fixed Height table has a single AV cutout)



Tia in-surface power features a unique hinged lid for dual-sided access with three choices of power configurations

Single-piece top available in all Watson laminates and Forbo finishes

Monitor Mount supports monitors up to 55" and up to 60 lbs.

Embedded control switch flush-mounted in table surface in clear aluminum finish

Lifting column constructed using a precision-formed steel shroud. Adjustment range from 28" to 47.5"

Fixed height 29.5"

User accessible utility power below the table surface

Cables are routed out the back of the Tech Cabinet to wall power. Cabinet backs are recessed so they can sit flush against the wall.

# Tia Team Tables Specifications

## Team Size Logic

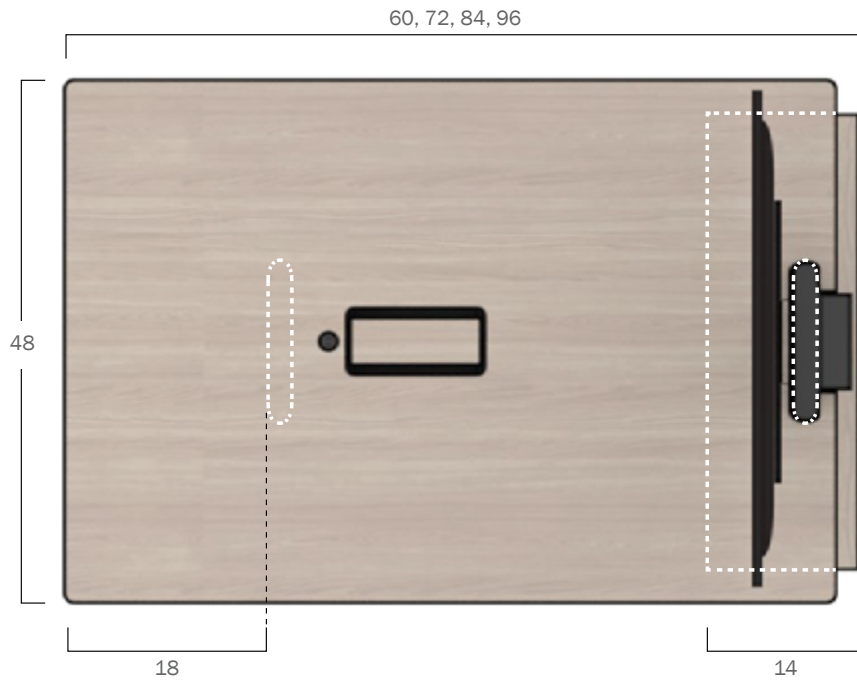

## Table Top Options

*Rectangle*

**D:** 48

**W:** 60, 72, 84, 96

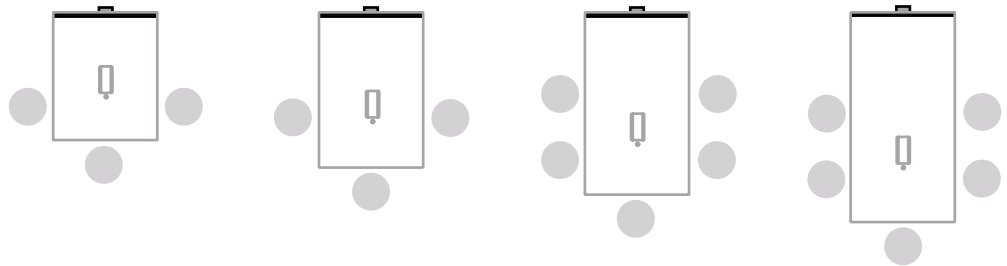
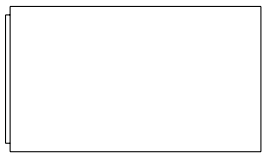

*Super Ellipse*

**D:** 48

**W:** 60, 72, 84, 96

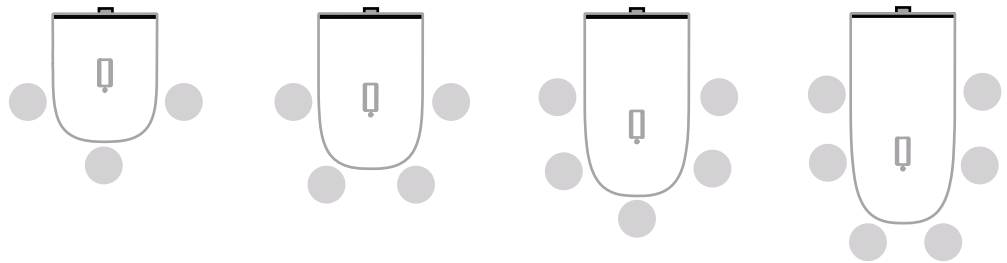

*Tapered*

**D:** 54 - 48

**W:** 60, 72, 84, 96

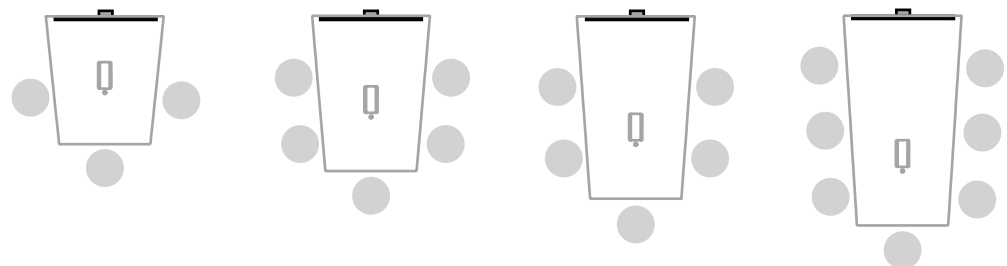
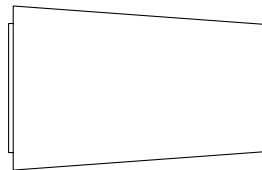

## Tia Conference Tables

### Edge Options

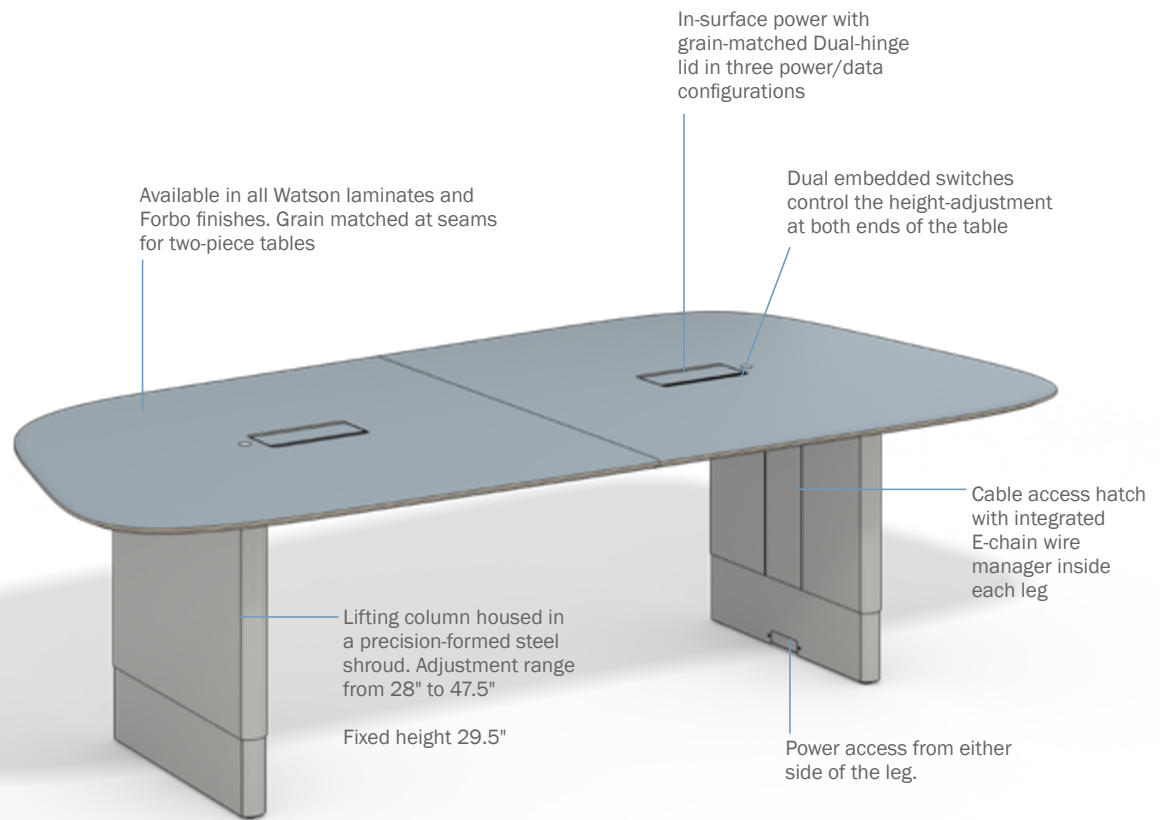
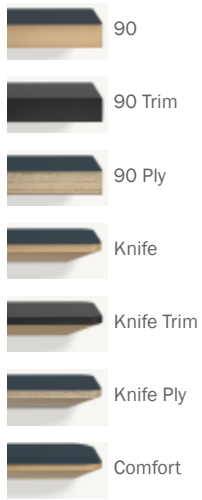

### Power Switch

The height-adjustment is controlled through a flush mounted switch embedded in the surface. This is typical for all Tia surfaces.



# Tia Conference Tables

## Table Top Options

### Rectangle

**D:** 42, 48, 54, 60

**W:** 84 - 144

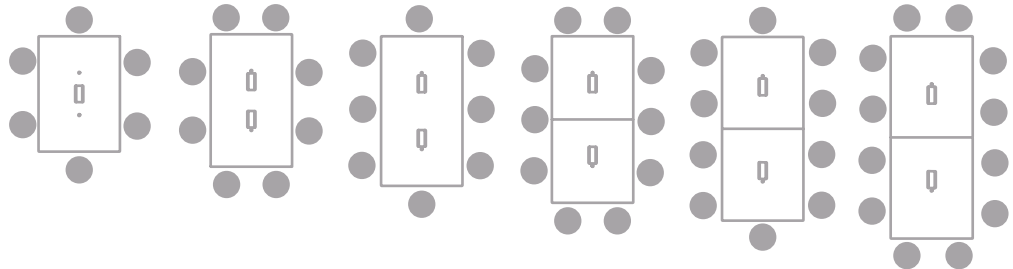

### Boat

**D:** 60

**W:** 84 - 144

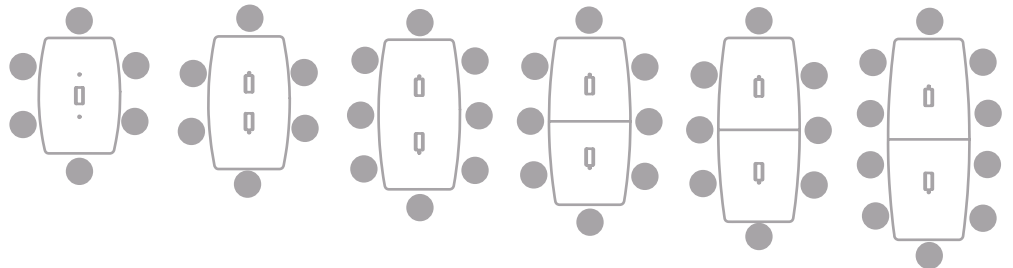
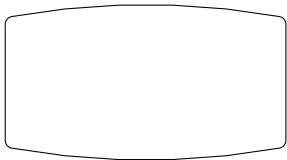

### Super Ellipse

**D:** 48, 54, 60

**W:** 84 - 144

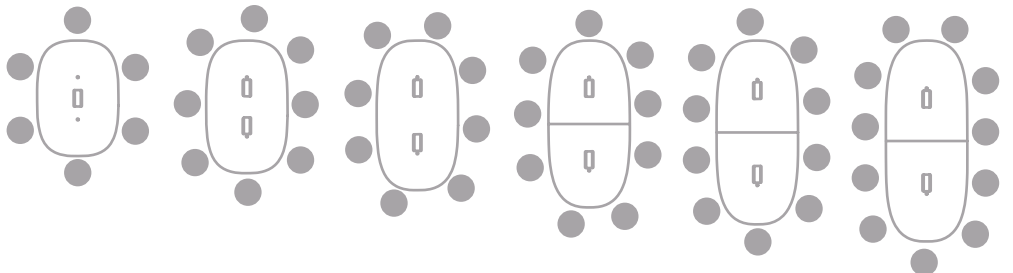
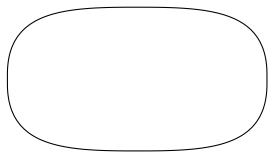

### Tapered

**D:** 60 - 48

**W:** 84 - 144

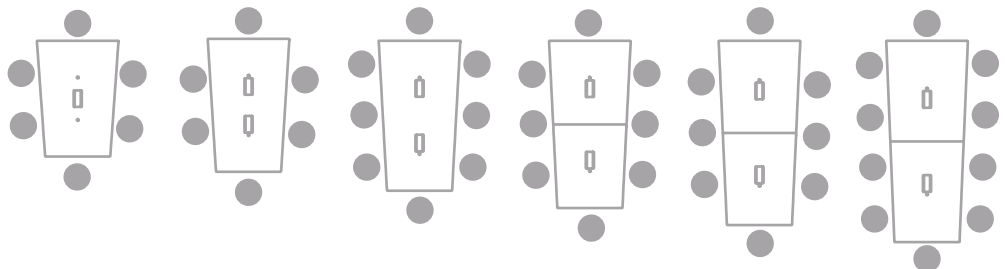
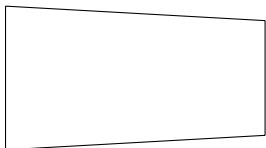

### Riverstone

**D:** 60

**W:** 84 - 120

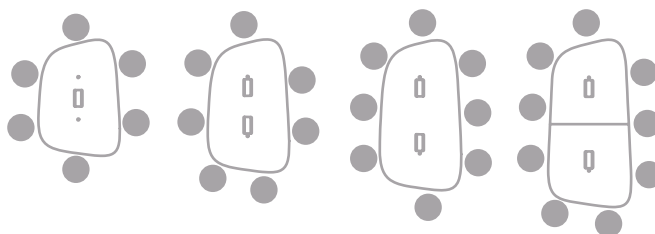
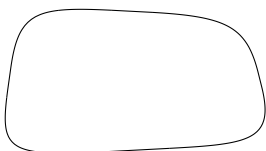

\*Showing 60" table depths



## Tia Conference Cable Management



Cables for lifting columns and power/data are routed through a high capacity E-chain in each column. Removable access hatch on inside of each column

Infeed access from either side of the leg. Discrete adjustable glides under each lifting column



### Optional Cable Bridge

Steel Cable Bridge facilitates concealed wire management from the floor core to either leg.

84 - 144W

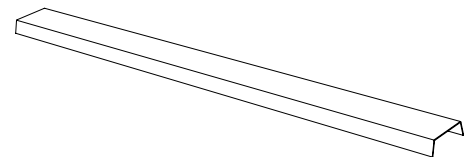

## Tia Team & Conference Power Options

### In-Surface Power

The Dual-hinge power unit is Watson's unique two-way access to Tia in-surface power/data. Lids are grain-matched to the worksurface and house ample space beneath for excess cables.



Available in the following three power/data configurations:

#### *Dual-hinge Full*

3 Power  
USB A+C  
1 HDMI  
1 CAT6



#### Power Locations

##### Tia Team



Centered in-surface power with optional grommet

#### *Dual-hinge Basic*

Commercial 4 power plug strip  
1 HDMI  
1 CAT6  
10' Cord



##### Tia Conference



Centered in-surface power



Centered in-surface power with optional grommet at end 1 and/or end 2

#### *Dual-hinge Open (no power)*

1 HDMI  
1 CAT6



Dual in-surface power with optional center grommet

## Tia Conference Sideboard

The Tia Sideboard Credenza is counter-height which makes it ideal for hospitality uses in the conference room. Doors provide ample room for storing service wear, binders, or technology. Available with Tab Pulls or touch-latch Cove Pulls.

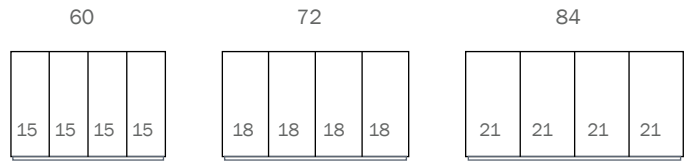

---

## Tia Team & Conference Tables | Product Specification Details

### Team Table Storage

The Team table storage cabinet shell, face and internal partitions are constructed of 3/4" thick laminated industrial grade NAF particleboard finished with color matched 1.5mm polypropylene edge banding. The storage top and plinth panels are made from 1-1/8" thick laminate industrial grade NAF particleboard finished with color matched 1.5mm polypropylene edge banding. The cabinet shell and internal partitions are charcoal. The storage cladding material is 1/2" thick laminated industrial grade NAF particleboard finished with color matched 1.5mm polypropylene edge banding. The flush doors are operable using touch release hardware. Tab pulls are made from anodized aluminum and have subtly rounded edges and corners to prevent damage to adjacent objects. The leg clamp bracketry is made from 12-gauge cold rolled steel welded and powdered for maximum durability. The lifting mechanisms are provided by Linak and securely clamped in place to provide maximum worksurface stability. Cable management internal to the cabinet is provided by an injection molded plastic energy chain ensuring enough cable length is present in the height adjustable desk. The leg shroud is constructed from 22-gauge cold rolled steel formed with a subtle D shape.

### Team/Conference Table Surfaces

The Tia team and conference worksurfaces tops are made from either 1-1/8" M2 industrial NAF particleboard or 27mm double refined NAF MDF finished with high pressure laminate or Forbo furniture linoleum. The Forbo surface can have a softened waterfall edge achieved using a fused laminated NAF MDF core that is profiled and sanded prior to having the linoleum vacuum press applied. All connections are made using a robust #10-1" wood screw. User accessible power is available as an optional add on, access is provided via a dual-action aluminum extrusion and injection molded component assembly that can rotate open from two sides. The power trough contains 3-outlets and dual charging USB, there are additional knockouts for HDMI and network connections.

### Tia Table Legs

The Tia table legs are constructed from two discrete oval shrouds each constructed of two pieces of formed 22-gauge cold rolled steel that are welded together using a continuous linear TIG welding machine and finally ground flush to have a complexly seamless appearance. The shrouds are kept from scratching each other during table operation using a super simple felt guiding system. The base of each leg is a 1/4" thick laser cut hot rolled steel piece. The tops of the electric adjustable legs are held securely using a 12-gauge bracket. All metal components are powder coated to individually match customer expectation.

### AV Mount

The AV mount is constructed from cold rolled steel and supports up to a 400mm x 400mm VESA mount configuration. The unit is held securely to a table edge using an innovative formed steel clamp which requires only 4.5" of surface depth above the worksurface and 1.5" underneath. The clamp is designed to work on any square edge surface between 3/4" and 1-1/4" thick.

### Modesty Panel

The Tia modesty panel is available as an 18-gauge powder coated cold rolled steel sheet formed with a larger radius corner to match the top shape. The guest facing side of the modesty panel can be wrapped in Forbo linoleum.

# Finish Guide

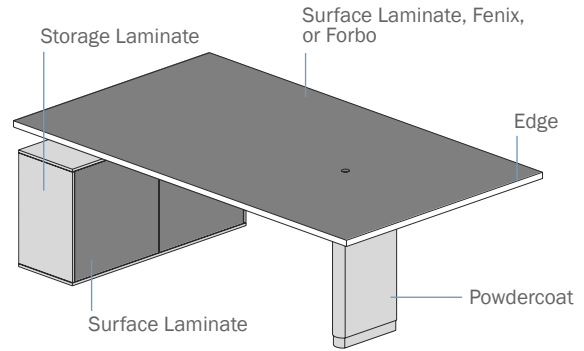
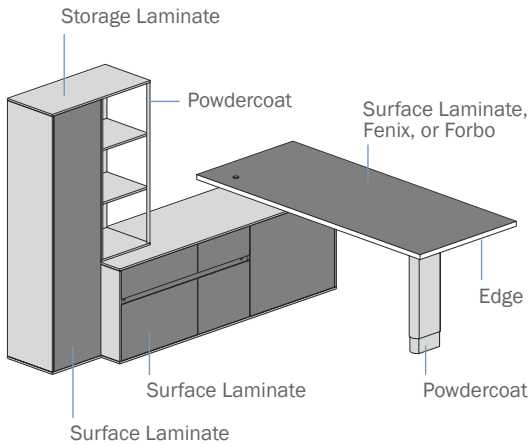

## Surface Laminate

	Alabaster	AB
	Frosty White	FJ
	Markerboard <sup>§</sup>	WM
	Fashion Grey	FQ
	Black	BK
Woodgrain	White Cypress	WCS
	Fawn Cypress	FCZ
	Asian Sand	JS
	Phantom Pearl	PPE
	Phantom Ecru	PEC
	Grey Elm	GEL
	Field Elm	FLM
	Loft Oak	LOA
	Blond Echo	EH
	Veranda Teak	VTK
	Neo Walnut	NEW
	Walnut Heights	WTH
	Skyline Walnut	SKW
	Studio Teak	DT
	Ebony Recon	ERE
Craft Surface	Saddle	BKR

<sup>§</sup>Markerboard  
+\$100 per surface  
list upcharge

## Fenix Laminate

	Bianco Kos	MWH
	Castoro Ottawa	MBR
	Nero Ingo	MBK

**\*Fenix NTM Laminate**  
An extremely matte laminate with anti-finger-printing and anti-bacterial properties. **Upcharges by surface size:**  
**Under 30x72 +\$440 list**  
**Over 30x72 +\$880 list**

## Forbo Linoleum

	Forbo Ash	FAS
	Forbo Pebble	FPE
	Forbo Mushroom	FMU
	Forbo Olive	FOL
	Forbo Pewter	FPW
	Forbo Noir	FNE
	Forbo Smokey Blue	FSB

**\*Forbo Linoleum**  
A super green material with a leather-like texture and a matte finish.  
**Upcharge: +\$250 list ea.**

## Storage Laminate

	Frosty White	FJ
	Fashion Grey	FQ
	Satin Gray	GY
	Slate	SG
	Charcoal	CH
Woodgrain	Black	BK
	Field Elm	FLM
	Phantom Ecru	PEC
	Blond Echo	EH
	Fawn Cypress	FCZ
	Studio Teak	DT
	Walnut Heights	WTH

## Edge Profile

90	90 °	U
	90 Trim	Q
	90 Ply °°	V
Knife	Knife °	K
	Knife Trim °	J
	Knife Ply °°	W
	Comfort °°°	P

**\* MDF edge**  
+\$150 per surface list upcharge  
**°° 90 Ply & Knife Ply +\$350 per surface**  
**°°° Comfort Edge**  
Only available with Forbo Linoleum surface material.  
**+\$900 for Forbo with Comfort Edge per surface**

## Edge Trim Color

Stain	Charcoal <sup>†</sup>	CH
	Natural	ZE
Trim	Alabaster	AB
	Frosty White	FJ
	Fashion Grey	FQ
	Satin Gray	GY
	Slate	SG
	Charcoal	CH
	Black	BK
	Field Elm	FLM
	Phantom Ecru	PEC
	Blond Echo	EH
	Fawn Cypress	FCZ
	Studio Teak	DT
	Walnut Heights	WTH
Ply	Natural	ZE

<sup>†</sup>Charcoal Stain  
+\$50 per surface  
list upcharge

## Powdercoat

	Alabaster	AB
	Frosty White	FJ
	Markerboard	WM
	Fashion Grey	FQ
	Silver	WA
	Satin Gray	GY
	Slate	SG
	Charcoal	CH
	Black	BK
	Aqua	AQU
	Burnt Orange	REO
	Mustard Seed	LEY
	Emerald Green	PIG
	Sage Green	PAG
	Blue Steel	BLG
	Stone	STG
	Bark	BRK
	Blush	BLU
	Crema	CRE
	Sapphire	SAP
	Ruby	RBY

## Fabric

Synergy 66*	Affix	AFI
	Alike	ALK
	Append	APP
	Chemistry	CHE
	Group	GRO
	Kinship	KIN
	Loop	LOO
	Mutual	MUT
	Pact	PAC
	Serendipity	SER
	Summon	SUM
	Work	WOR
Rivet	Tensile	TEN
	Vitreous	VIT
	Wire	WRE
	Forge	FRG
	Spark	SPK
	Molten	MLT
	Otter	OTR
	Alloy	ALY
	Grey Brindle	GRB
	Galvanize	GLV
	Lagoon	LGN
	Quench	QUE

**\*Synergy 66**  
+\$250 per item  
list upcharge

## Fabric cont.

PET	Light	SIA63
	Medium	HTA23
	Dark	CHA21
Anchorage	Angora	9A
	Asteroid	6D
	Birch	9H
	Cumin	9U
	Fossil	6X
	Geranium	R2
	Goose	9E
	Graphite	9R
	Green Apple	1G
	Henna	6H
	Pumpkin	99
	Straw	9S
	Sunshine	S8
	Waterfall	U8
	Vanilla	6V
Sprite	Sprite Snow	2W
	Sprite Linen	2I
	Sprite Khaki	7K
	Sprite Harvest	2V
	Sprite Sky	7Y

## Extended Powdercoat Program

Additional RAL colors are available as part of Watson's Extended Powdercoat Program. Please consult with your account manager to ensure your powder selection is available. Some pearls and metallics are not offered.

- **Upcharge: \$1760 list per order, per color**
- **Leadtime: Contact the Factory for Leadtime**

## Tia Office

### 60W Drawer Support Credenza

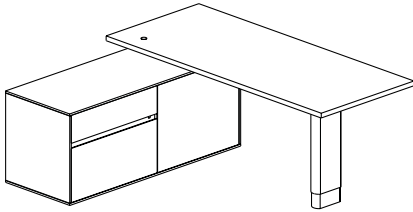

#### Options & Upcharges

**Pull:** Cove / Tab (Silver) / Tab (Black)

**Power & Tech:** Undersurface (+\$760) / Grommet (+\$55)

**Edge Profiles:** 90 (+\$150) / 90 Trim / Knife (+\$150) / Knife Trim (+\$150) / 90 Ply (+\$350) / Knife Ply (+\$350) / Comfort (+\$900) (Comfort edge only available with Forbo surface material)

#### Notes

- Desk depth and width are net sized, and are an inch less in actual dimension
- HA model shown
- Unit is handed, specify left or right (L/R)

D	W	STORAGE HEIGHT	MODEL NUMBER	PRICE	PRICE
				HA	FIXED
30	60	24	<b>APD2D603060</b>	9070	6070
30	72	24	<b>APD2D603072</b>	9180	6180
30	84	24	<b>APD2D603084</b>	9650	6650
36	72	24	<b>APD2D603672</b>	9750	6750
36	84	24	<b>APD2D603684</b>	10500	7500
36	96	24	<b>APD2D603696</b>	10610	7610

## Tia Office

### 72W Drawer Support Credenza

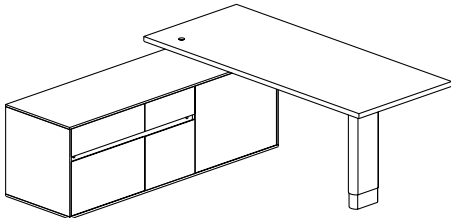

#### Options & Upcharges

**Pull:** Cove / Tab (Silver) / Tab (Black)

**Power & Tech:** Undersurface (+\$760) / Grommet (+\$55)

**Edge Profiles:** 90 (+\$150) / 90 Trim / Knife (+\$150) / Knife Trim (+\$150) / 90 Ply (+\$350) / Knife Ply (+\$350) / Comfort (+\$900) (Comfort edge only available with Forbo surface material)

#### Notes

- Desk depth and width are net sized, and are an inch less in actual dimension
- HA model shown
- Unit is handed, specify left or right (L/R)

D	W	STORAGE HEIGHT	MODEL NUMBER	PRICE	PRICE
				HA	FIXED
30	60	24	<b>APD2D723060</b>	10630	7630
30	72	24	<b>APD2D723072</b>	10750	7750
30	84	24	<b>APD2D723084</b>	11240	8240
36	72	24	<b>APD2D723672</b>	11370	8370
36	84	24	<b>APD2D723684</b>	12120	9120
36	96	24	<b>APD2D723696</b>	12250	9250

## Tia Office

### 72W Combo Support Credenza

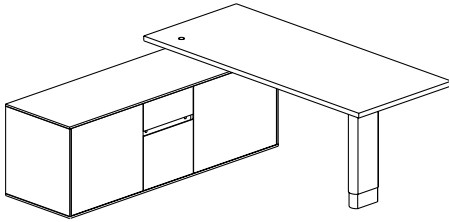

#### Options & Upcharges

**Pull:** Cove / Tab (Silver) / Tab (Black)

**Power & Tech:** Undersurface (+\$760) / Grommet (+\$55)

**Edge Profiles:** 90 (+\$150) / 90 Trim / Knife (+\$150) / Knife Trim (+\$150) / 90 Ply (+\$350) / Knife Ply (+\$350) / Comfort (+\$900) (Comfort edge only available with Forbo surface material)

#### Notes

- Desk depth and width are net sized, and are an inch less in actual dimension
- HA model shown
- Unit is handed, specify left or right (L/R)

D	W	STORAGE HEIGHT	MODEL NUMBER	PRICE	PRICE
				HA	FIXED
30	60	24	<b>APD2C723060</b>	9240	6240
30	72	24	<b>APD2C723072</b>	9410	6410
30	84	24	<b>APD2C723084</b>	10040	7040
36	72	24	<b>APD2C723672</b>	10150	7150
36	84	24	<b>APD2C723684</b>	10870	7870
36	96	24	<b>APD2C723696</b>	10990	7990

## Tia Office

### 84W Drawer Support Credenza

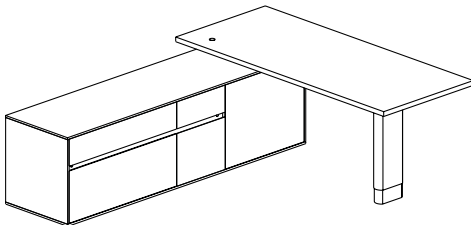

#### Options & Upcharges

**Pull:** Cove / Tab (Silver) / Tab (Black)

**Power & Tech:** Undersurface (+\$760) / Grommet (+\$55)

**Edge Profiles:** 90 (+\$150) / 90 Trim / Knife (+\$150) / Knife Trim (+\$150) / 90 Ply (+\$350) / Knife Ply (+\$350) / Comfort (+\$900) (Comfort edge only available with Forbo surface material)

#### Notes

- Desk depth and width are net sized, and are an inch less in actual dimension
- HA model shown
- Unit is handed, specify left or right (L/R)

D	W	STORAGE HEIGHT	MODEL NUMBER	PRICE	PRICE
				HA	FIXED
30	60	24	<b>APD2D843060</b>	10750	7750
30	72	24	<b>APD2D843072</b>	10870	7870
30	84	24	<b>APD2D843084</b>	11370	8370
36	72	24	<b>APD2D843672</b>	11500	8500
36	84	24	<b>APD2D843684</b>	12250	9250
36	96	24	<b>APD2D843696</b>	12380	9380

## Tia Office

### 84W Combo Support Credenza

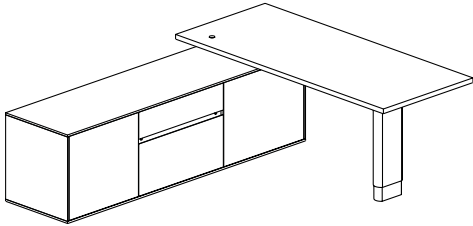

#### Options & Upcharges

**Pull:** Cove / Tab (Silver) / Tab (Black)

**Power & Tech:** Undersurface (+\$760) / Grommet (+\$55)

**Edge Profiles:** 90 (+\$150) / 90 Trim / Knife (+\$150) / Knife Trim (+\$150) / 90 Ply (+\$350) / Knife Ply (+\$350) / Comfort (+\$900) (Comfort edge only available with Forbo surface material)

#### Notes

- Desk depth and width are net sized, and are an inch less in actual dimension
- HA model shown
- Unit is handed, specify left or right (L/R)

D	W	STORAGE HEIGHT	MODEL NUMBER	PRICE	PRICE
				HA	FIXED
30	60	24	<b>APD2C843060</b>	9880	6880
30	72	24	<b>APD2C843072</b>	9990	6990
30	84	24	<b>APD2C843084</b>	10490	7490
36	72	24	<b>APD2C843672</b>	10600	7600
36	84	24	<b>APD2C843684</b>	11350	8350
36	96	24	<b>APD2C843696</b>	11470	8470

## Tia Office

### 96W Drawer Support Credenza

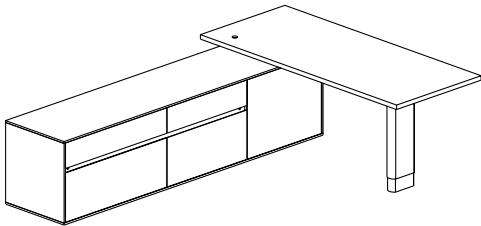

#### Options & Upcharges

**Pull:** Cove / Tab (Silver) / Tab (Black)

**Power & Tech:** Undersurface (+\$760) / Grommet (+\$55)

**Edge Profiles:** 90 (+\$150) / 90 Trim / Knife (+\$150) / Knife Trim (+\$150) / 90 Ply (+\$350) / Knife Ply (+\$350) / Comfort (+\$900) (Comfort edge only available with Forbo surface material)

#### Notes

- Desk depth and width are net sized, and are an inch less in actual dimension
- HA model shown
- Unit is handed, specify left or right (L/R)

D	W	STORAGE HEIGHT	MODEL NUMBER	PRICE	PRICE
				HA	FIXED
30	60	24	<b>APD2D963060</b>	10990	7990
30	72	24	<b>APD2D963072</b>	11110	8110
30	84	24	<b>APD2D963084</b>	11630	8630
36	72	24	<b>APD2D963672</b>	11750	8750
36	84	24	<b>APD2D963684</b>	12510	9510
36	96	24	<b>APD2D963696</b>	12650	9650



## Tia Office

96W Combo Support Credenza

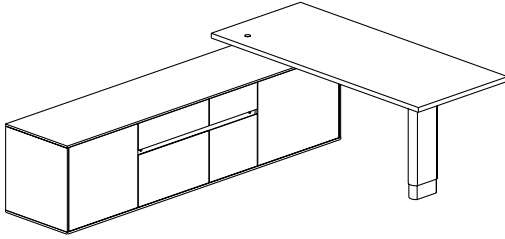

### Options & Upcharges

**Pull:** Cove / Tab (Silver) / Tab (Black)

**Power & Tech:** Undersurface (+\$760) / Grommet (+\$55)

**Edge Profiles:** 90 (+\$150) / 90 Trim / Knife (+\$150) / Knife Trim (+\$150) / 90 Ply (+\$350) / Knife Ply (+\$350) / Comfort (+\$900) (Comfort edge only available with Forbo surface material)

### Notes

- Desk depth and width are net sized, and are an inch less in actual dimension
- HA model shown

D	W	STORAGE HEIGHT	MODEL NUMBER	PRICE HA	PRICE FIXED
30	60	24	<b>APD2C963060</b>	10860	7860
30	72	24	<b>APD2C963072</b>	11110	8110
30	84	24	<b>APD2C963084</b>	11630	8630
36	72	24	<b>APD2C963672</b>	11750	8750
36	84	24	<b>APD2C963684</b>	12510	9510
36	96	24	<b>APD2C963696</b>	12650	9650

## Tia Modesty

Steel

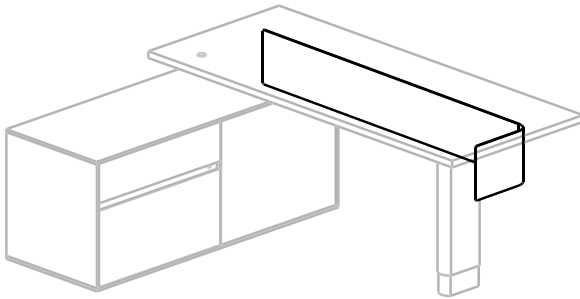

W	H	MODEL NUMBER (LEFT HAND)	MODEL NUMBER (RIGHT HAND)	PRICE
60	8	<b>APMP0860L</b>	<b>APMP0860R</b>	440
72	8	<b>APMP0872L</b>	<b>APMP0872R</b>	440
84	8	<b>APMP0884L</b>	<b>APMP0884R</b>	440
96	8	<b>APMP0896L</b>	<b>APMP0896R</b>	440

## Tia Modesty

Steel with Forbo

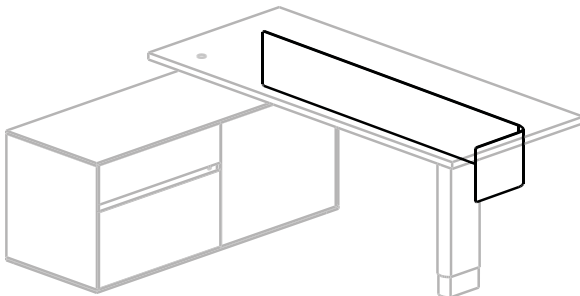

W	H	MODEL NUMBER (LEFT HAND)	MODEL NUMBER (RIGHT HAND)	PRICE
60	8	<b>APMF0860L</b>	<b>APMF0860R</b>	720
72	8	<b>APMF0872L</b>	<b>APMF0872R</b>	720
84	8	<b>APMF0884L</b>	<b>APMF0884R</b>	720
96	8	<b>APMF0896L</b>	<b>APMF0896R</b>	720

---

## Tia Office

*Credenza Removable Back*

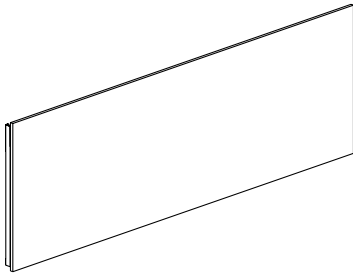

<b>DESK DEPTH</b>	<b>W</b>	<b>H</b>	<b>MODEL NUMBER</b>	<b>PRICE</b>
30	60	24	<b>APD2CB306024</b>	280
30	72	24	<b>APD2CB307224</b>	280
30	84	24	<b>APD2CB308424</b>	280
30	96	24	<b>APD2CB309624</b>	280
36	60	24	<b>APD2CB366024</b>	280
36	72	24	<b>APD2CB367224</b>	280
36	84	24	<b>APD2CB368424</b>	280
36	96	24	<b>APD2CB369624</b>	280

---

## Clamp on Monitor Mount

*For Tia Run-off Desk*

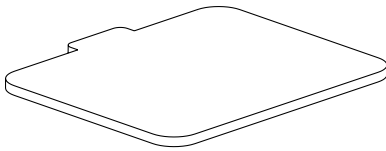

<b>MODEL NUMBER</b>	<b>PRICE</b>
<b>APD2MM</b>	60

---

## Tia Free Standing Credenza

Door

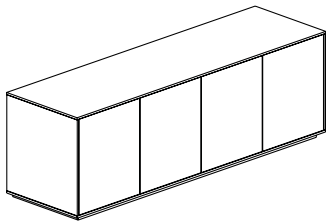

### Options & Upcharges

Pull: Cove / Tab (Silver) / Tab (Black)

### Notes

- 72W model shown

D	W	H	MODEL NUMBER	PRICE
20	60	24	<b>APFS2D206024</b>	3150
20	72	24	<b>APFS2D207224</b>	3180
20	84	24	<b>APFS2D208424</b>	3210

---

## Tia Free Standing Credenza

Combo

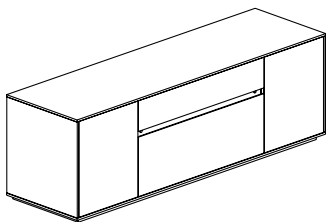

### Options & Upcharges

Pull: Cove / Tab (Silver) / Tab (Black)

### Notes

- 72W model shown

D	W	H	MODEL NUMBER	PRICE
20	60	24	<b>APFS2C206024</b>	5210
20	72	24	<b>APFS2C207224</b>	5260
20	84	24	<b>APFS2C208424</b>	5310

---

## Tia Free Standing Credenza

Drawer

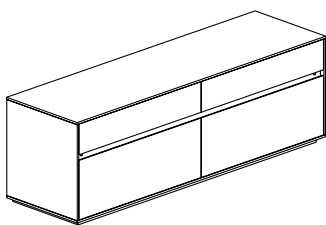

### Options & Upcharges

Pull: Cove / Tab (Silver) / Tab (Black)

### Notes

- 72W model shown
- Internal drawer widths are 28", 34", 40" respectively.

D	W	H	MODEL NUMBER	PRICE
20	60	24	<b>APFS2F206024</b>	5800
20	72	24	<b>APFS2F207224</b>	5860
20	84	24	<b>APFS2F208424</b>	5910

---

## Tia Freestanding Credenza

Removable Back

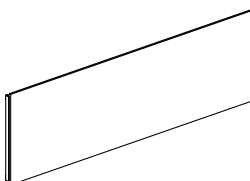

W	H	MODEL NUMBER	PRICE
60	24	<b>APFS2CB6024</b>	270
72	24	<b>APFS2CB7224</b>	270
84	24	<b>APFS2CB8424</b>	270

---

## Tia Secondary Storage Stacker

Door / 15" Open

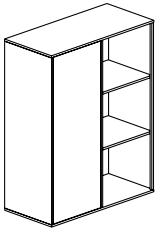

### Options & Upcharges

Pull: Cove / Tab (Silver) / Tab (Black)

### Notes

- 60H model shown
- Unit is handed, specify left or right (L/R)

D	W	H	MODEL NUMBER	PRICE
14	30	48	<b>APSS2L143048</b>	2310
14	30	60	<b>APSS2L143060</b>	2330
14	30	72	<b>APSS2L143072</b>	2360

---

## Tia Secondary Storage Stacker

Door Pair

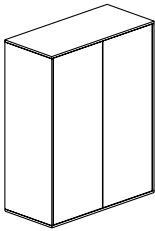

### Options & Upcharges

Pull: Cove / Tab (Silver) / Tab (Black)

### Notes

- 60H model shown

D	W	H	MODEL NUMBER	PRICE
14	30	48	<b>APSS2D143048</b>	2550
14	30	60	<b>APSS2D143060</b>	2580
14	30	72	<b>APSS2D143072</b>	2600

---

## Tia Secondary Storage Stacker

Door / 24" Open

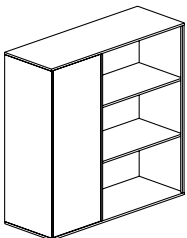

### Options & Upcharges

Pull: Cove / Tab (Silver) / Tab (Black)

### Notes

- 60H model shown
- Unit is handed, specify left or right (L/R)

D	W	H	MODEL NUMBER	PRICE
14	39	48	<b>APSS2W143948</b>	2310
14	39	60	<b>APSS2W143960</b>	2330
14	39	72	<b>APSS2W143972</b>	2360

---

## Tia Secondary Storage Locker

15" Open / 15" Locker Door

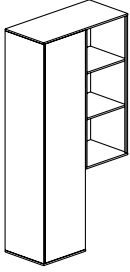

### Options & Upcharges

Pull: Cove / Tab (Silver) / Tab (Black)

### Notes

- 60H model shown
- Unit is handed, specify left or right (L/R)

D	W	H	MODEL NUMBER	PRICE
14	30	48	<b>APSL20143048</b>	2890
14	30	60	<b>APSL20143060</b>	2920
14	30	72	<b>APSL20143072</b>	2950

---

## Tia Secondary Storage Locker

15" Door / 15" Locker Door

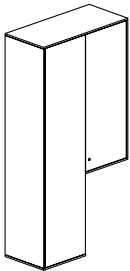

### Options & Upcharges

Pull: Cove / Tab (Silver) / Tab (Black)

### Notes

- 60H model shown
- Unit is handed, specify left or right (L/R)

D	W	H	MODEL NUMBER	PRICE
14	30	48	<b>APSL2D143048</b>	3230
14	30	60	<b>APSL2D143060</b>	3260
14	30	72	<b>APSL2D143072</b>	3290

---

## Tia Secondary Storage Locker

24" Open / 15" Locker Door

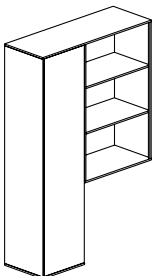

### Options & Upcharges

Pull: Cove / Tab (Silver) / Tab (Black)

### Notes

- 60H model shown
- Unit is handed, specify left or right (L/R)

D	W	H	MODEL NUMBER	PRICE
14	39	48	<b>APSL2W143948</b>	2890
14	39	60	<b>APSL2W143960</b>	2920
14	39	72	<b>APSL2W143972</b>	2950

---

## Tia Secondary Storage Locker

15" Open / 15" Door / 15" Locker Door

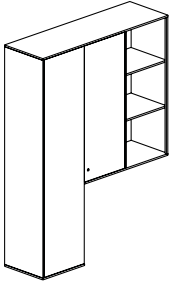

### Options & Upcharges

Pull: Cove / Tab (Silver) / Tab (Black)

### Notes

- 60H model shown
- Unit is handed, specify left or right (L/R)

D	W	H	MODEL NUMBER	PRICE
14	45	48	<b>APSL2C144548</b>	3900
14	45	60	<b>APSL2C144560</b>	3940
14	45	72	<b>APSL2C144572</b>	3980

---

## Tia Secondary Storage Locker

24" Open / 15" Door / 15" Locker Door

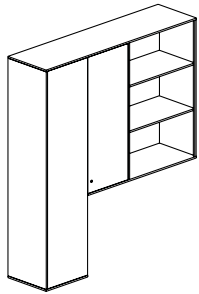

### Options & Upcharges

Pull: Cove / Tab (Silver) / Tab (Black)

### Notes

- 60H model shown
- Unit is handed, specify left or right (L/R)

D	W	H	MODEL NUMBER	PRICE
14	54	48	<b>APSL2X145448</b>	3900
14	54	60	<b>APSL2X145460</b>	3940
14	54	72	<b>APSL2X145472</b>	3980

---

## Tia Secondary Storage Wardrobe

15" Open / 24" Wardrobe Door

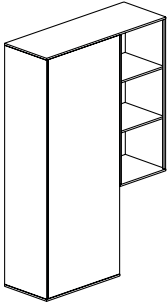

### Options & Upcharges

Pull: Cove / Tab (Silver) / Tab (Black)

### Notes

- 60H model shown
- Unit is handed, specify left or right (L/R)

D	W	H	MODEL NUMBER	PRICE
14	39	48	<b>APSW20143948</b>	2890
14	39	60	<b>APSW20143960</b>	2920
14	39	72	<b>APSW20143972</b>	2950

---

## Tia Secondary Storage Wardrobe

15" Door / 24" Wardrobe Door

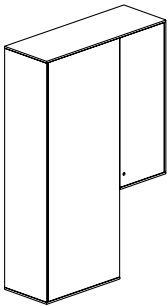

### Options & Upcharges

Pull: Cove / Tab (Silver) / Tab (Black)

### Notes

- 60H model shown
- Unit is handed, specify left or right (L/R)

D	W	H	MODEL NUMBER	PRICE
14	39	48	<b>APSW2D143948</b>	3230
14	39	60	<b>APSW2D143960</b>	3260
14	39	72	<b>APSW2D143972</b>	3290

---

## Tia Secondary Storage Wardrobe

24" Open / 24" Wardrobe Door

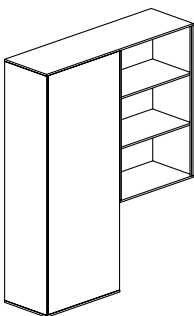

### Options & Upcharges

Pull: Cove / Tab (Silver) / Tab (Black)

### Notes

- 60H model shown
- Unit is handed, specify left or right (L/R)

D	W	H	MODEL NUMBER	PRICE
14	48	48	<b>APSW2W144848</b>	2890
14	48	60	<b>APSW2W144860</b>	2920
14	48	72	<b>APSW2W144872</b>	2950

---

## Tia Secondary Storage Wardrobe

15" Open / 15" Door / 24" Wardrobe Door

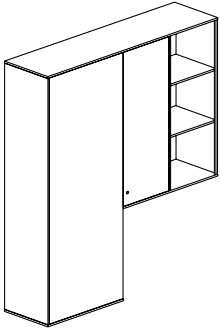

### Options & Upcharges

Pull: Cove / Tab (Silver) / Tab (Black)

### Notes

- 60H model shown
- Unit is handed, specify left or right (L/R)

D	W	H	MODEL NUMBER	PRICE
14	54	48	<b>APSW2C145448</b>	3900
14	54	60	<b>APSW2C145460</b>	3940
14	54	72	<b>APSW2C145472</b>	3980

---

## Tia Secondary Storage Wardrobe

24" Open / 15" Door / 24" Wardrobe Door

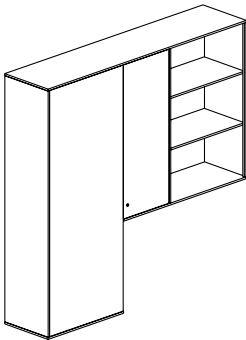

### Options & Upcharges

Pull: Cove / Tab (Silver) / Tab (Black)

### Notes

- 60H model shown
- Unit is handed, specify left or right (L/R)

D	W	H	MODEL NUMBER	PRICE
14	63	48	<b>APSW2X146348</b>	3900
14	63	60	<b>APSW2X146360</b>	3940
14	63	72	<b>APSW2X146372</b>	3980



## Tia Team Table

Rectangular

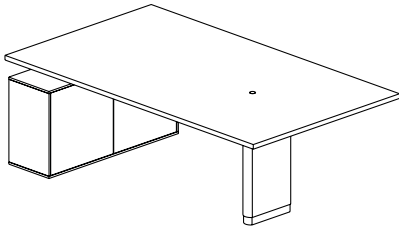

### Options & Upcharges

Pull: Cove / Tab (Silver) / Tab (Black)

Power & Tech: Grommet (+\$55) / See pages 41-42 for power options and pricing

Edge Profiles: 90 (+\$150) / 90 Trim / Knife (+\$150) / Knife Trim (+\$150) / 90 Ply (+\$350) / Knife Ply (+\$350) / Comfort (+\$900) (Comfort edge only available with Forbo surface material)

### Notes

- HA model shown

D	W	STORAGE		MODEL NUMBER	PRICE	PRICE
		H			HA	FIXED
48	60	24		<b>AMT2D4860</b>	9700	6450
48	72	24		<b>AMT2D4872</b>	9810	6560
48	84	24		<b>AMT2D4884</b>	9910	6660
48	96	24		<b>AMT2D4896</b>	10020	6770

## Tia Team Table

Tapered

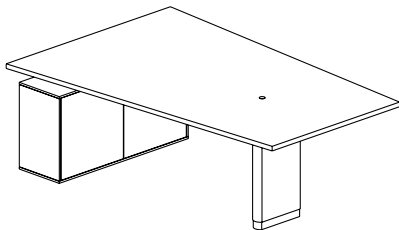

### Options & Upcharges

Pull: Cove / Tab (Silver) / Tab (Black)

Power & Tech: Grommet (+\$55) / See pages 41-42 for power options and pricing

Edge Profiles: 90 (+\$150) / 90 Trim / Knife (+\$150) / Knife Trim (+\$150) / 90 Ply (+\$350) / Knife Ply (+\$350) / Comfort (+\$900) (Comfort edge only available with Forbo surface material)

### Notes

- HA model shown

D	W	STORAGE		MODEL NUMBER	PRICE	PRICE
		H			HA	FIXED
54	60	24		<b>AMT2T5460</b>	9910	6660
54	72	24		<b>AMT2T5472</b>	10020	6770
54	84	24		<b>AMT2T5484</b>	10120	6870
54	96	24		<b>AMT2T5496</b>	10230	6980

## Tia Team Table

Super Ellipse

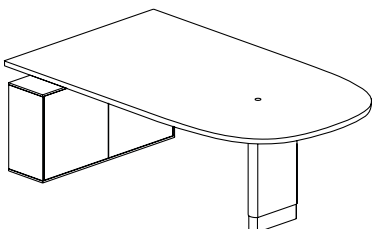

### Options & Upcharges

Pull: Cove / Tab (Silver) / Tab (Black)

Power & Tech: Grommet (+\$55) / See pages 41-42 for power options and pricing

Edge Profiles: 90 (+\$150) / 90 Trim / Knife (+\$150) / Knife Trim (+\$150) / 90 Ply (+\$350) / Knife Ply (+\$350) / Comfort (+\$900) (Comfort edge only available with Forbo surface material)

### Notes

- HA model shown

D	W	STORAGE		MODEL NUMBER	PRICE	PRICE
		H			HA	FIXED
48	60	24		<b>AMT2S4860</b>	10120	6870
48	72	24		<b>AMT2S4872</b>	10230	6980
48	84	24		<b>AMT2S4884</b>	10330	7080
48	96	24		<b>AMT2S4896</b>	10440	7190

---

## Tia Team Tech Cabinet

*Removable Back*

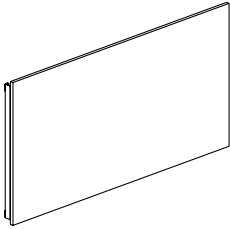

<b>W</b>	<b>H</b>	<b>MODEL NUMBER</b>	<b>PRICE</b>
42	24	<b>AMRTB4224</b>	290

---

## Tia Team Table Monitor Mount

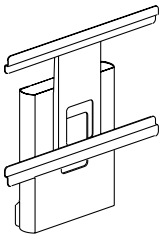

<b>W</b>	<b>H</b>	<b>MODEL NUMBER</b>	<b>PRICE</b>
14	18	<b>AM2AV1418</b>	1340

## Tia Conference Table

Rectangular, One-Piece

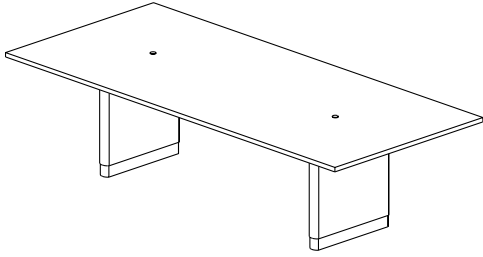

### Options & Upcharges

**Power & Tech:** Grommet (+\$55 each) / See pages 41-42 for power options and pricing

**Edge Profiles:** 90 (+\$150) / 90 Trim / Knife (+\$150) / Knife Trim (+\$150) / 90 Ply (+\$350) / Knife Ply (+\$350) / Comfort (+\$900)  
(Comfort edge only available with Forbo surface material)

D	W	MODEL NUMBER	PRICE	PRICE
			HA	FIXED
42	84	<b>ACTR4284</b>	9870	6370
42	96	<b>ACTR4296</b>	10000	6500
42	108	<b>ACTR42108</b>	10120	6620
48	84	<b>ACTR4884</b>	10000	6500
48	96	<b>ACTR4896</b>	10120	6620
48	108	<b>ACTR48108</b>	10250	6570
54	84	<b>ACTR5484</b>	10120	6620
54	96	<b>ACTR5496</b>	10250	6570
54	108	<b>ACTR54108</b>	10370	6870
60	84	<b>ACTR6084</b>	10250	6570
60	96	<b>ACTR6096</b>	10370	6870
60	108	<b>ACTR60108</b>	10500	7000

## Tia Conference Table

Rectangular, Two-Piece

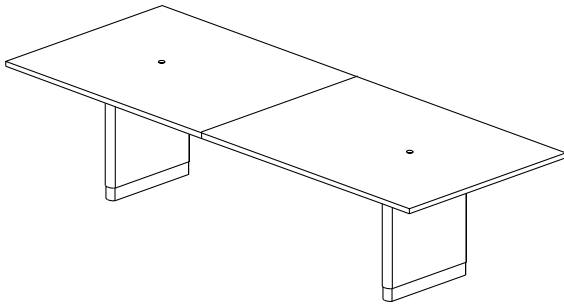

### Options & Upcharges

**Power & Tech:** Grommet (+\$55 each) / See pages 41-42 for power options and pricing

**Edge Profiles:** 90 (+\$300) / 90 Trim / Knife (+\$300) / Knife Trim (+\$300) / 90 Ply (+\$700) / Knife Ply (+\$700)

D	W	MODEL NUMBER	PRICE	PRICE
			HA	FIXED
42	120	<b>ACTR42120</b>	10000	6500
42	132	<b>ACTR42132</b>	10120	6620
42	144	<b>ACTR42144</b>	10250	6750
48	120	<b>ACTR48120</b>	10120	6620
48	132	<b>ACTR48132</b>	10250	6570
48	144	<b>ACTR48144</b>	10370	6870
54	120	<b>ACTR54120</b>	10250	6570
54	132	<b>ACTR54132</b>	10370	6870
54	144	<b>ACTR54144</b>	10500	7000
60	120	<b>ACTR60120</b>	10370	6870
60	132	<b>ACTR60132</b>	10500	7000
60	144	<b>ACTR60144</b>	10620	7120

## Tia Conference Table

Super Ellipse, One-Piece

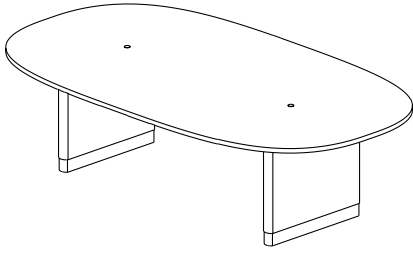

### Options & Upcharges

**Power & Tech:** Grommet (+\$55 each) / See pages 41-42 for power options and pricing

**Edge Profiles:** 90 (+\$150) / 90 Trim / Knife (+\$150) / Knife Trim (+\$150) / 90 Ply (+\$350) / Knife Ply (+\$350) / Comfort (+\$900) (Comfort edge only available with Forbo surface material)

D	W	MODEL NUMBER	PRICE HA	PRICE FIXED
48	84	<b>ACTS4884</b>	10100	6600
48	96	<b>ACTS4896</b>	10220	6720
48	108	<b>ACTS48108</b>	10350	6850
54	84	<b>ACTS5484</b>	10220	6720
54	96	<b>ACTS5496</b>	10350	6850
54	108	<b>ACTS54108</b>	10470	6970
60	84	<b>ACTS6084</b>	10350	6850
60	96	<b>ACTS6096</b>	10470	6970
60	108	<b>ACTS60108</b>	10600	7100

## Tia Conference Table

Super Ellipse, Two-Piece

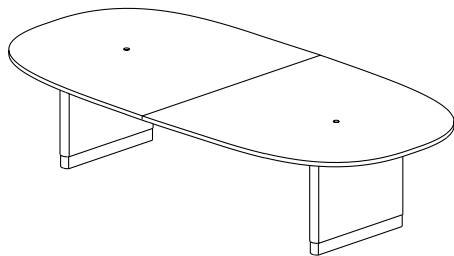

### Options & Upcharges

**Power & Tech:** Grommet (+\$55 each) / See pages 41-42 for power options and pricing

**Edge Profiles:** 90 (+\$300) / 90 Trim / Knife (+\$300) / Knife Trim (+\$300) / 90 Ply (+\$700) / Knife Ply (+\$700)

D	W	MODEL NUMBER	PRICE HA	PRICE FIXED
48	120	<b>ACTS48120</b>	10320	6820
48	132	<b>ACTS48132</b>	10450	6950
48	144	<b>ACTS48144</b>	10570	7070
54	120	<b>ACTS54120</b>	10450	6950
54	132	<b>ACTS54132</b>	10570	7070
54	144	<b>ACTS54144</b>	10700	7200
60	120	<b>ACTS60120</b>	10570	7070
60	132	<b>ACTS60132</b>	10700	7200
60	144	<b>ACTS60144</b>	10820	7320

---

## Tia Conference Table

*Tapered, One-Piece*

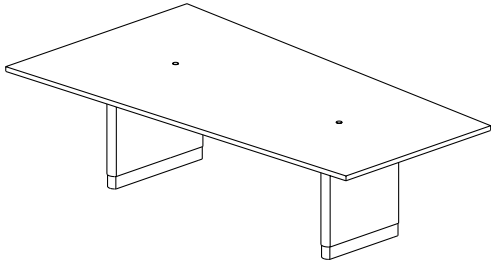

### Options & Upcharges

**Power & Tech:** Grommet (+\$55 each) / See pages 41-42 for power options and pricing

**Edge Profiles:** 90 (+\$150) / 90 Trim / Knife (+\$150) / Knife Trim (+\$150) /

<b>D</b>	<b>W</b>	<b>MODEL NUMBER</b>	<b>PRICE HA</b>	<b>PRICE FIXED</b>
60	84	<b>ACTT604884</b>	10350	6850
60	96	<b>ACTT604896</b>	10470	6970
60	108	<b>ACTT6048108</b>	10600	7100

---

## Tia Conference Table

*Tapered, Two-Piece*

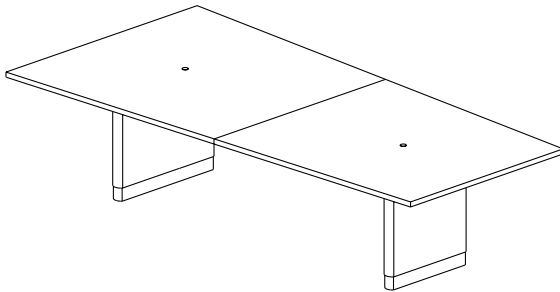

### Options & Upcharges

**Power & Tech:** Grommet (+\$55 each) / See pages 41-42 for power options and pricing

**Edge Profiles:** 90 (+\$300) / 90 Trim / Knife (+\$300) / Knife Trim (+\$300) /

<b>D</b>	<b>W</b>	<b>MODEL NUMBER</b>	<b>PRICE HA</b>	<b>PRICE FIXED</b>
60	120	<b>ACTT6048120</b>	10570	7070
60	132	<b>ACTT6048132</b>	10700	7200
60	144	<b>ACTT6048144</b>	10820	7320

---

## Tia Conference Table

Boat, One-Piece

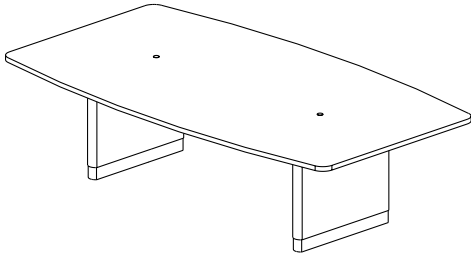

### Options & Upcharges

**Power & Tech:** Grommet (+\$55 each) / See pages 41-42 for power options and pricing

**Edge Profiles:** 90 (+\$150) / 90 Trim / Knife (+\$150) / Knife Trim (+\$150) / 90 Ply (+\$350) / Knife Ply (+\$350)

D	W	MODEL NUMBER	PRICE	PRICE
			HA	FIXED
60	84	<b>ACTB6084</b>	10350	6850
60	96	<b>ACTB6096</b>	10470	6970
60	108	<b>ACTB60108</b>	10600	7100

---

## Tia Conference Table

Boat, Two-Piece

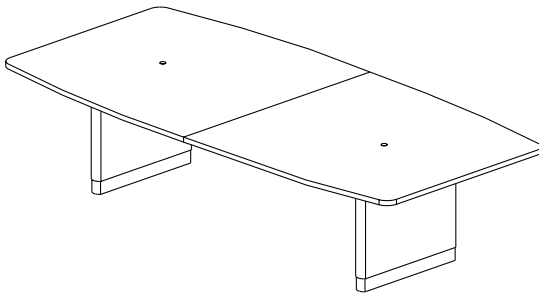

### Options & Upcharges

**Power & Tech:** Grommet (+\$55 each) / See pages 41-42 for power options and pricing

**Edge Profiles:** 90 (+\$300) / 90 Trim / Knife (+\$300) / Knife Trim (+\$300) / 90 Ply (+\$700) / Knife Ply (+\$700)

D	W	MODEL NUMBER	PRICE	PRICE
			HA	FIXED
60	120	<b>ACTB60120</b>	10570	7070
60	132	<b>ACTB60132</b>	10700	7200
60	144	<b>ACTB60144</b>	10820	7320

---

## Tia Conference Table

Cable Pathway

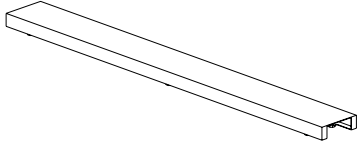

W	MODEL NUMBER	PRICE
84	<b>ACCP84</b>	750
96	<b>ACCP96</b>	750
108	<b>ACCP108</b>	750
120	<b>ACCP120</b>	750
132	<b>ACCP132</b>	750
144	<b>ACCP144</b>	750

---

## Sideboard Credenza

Doors

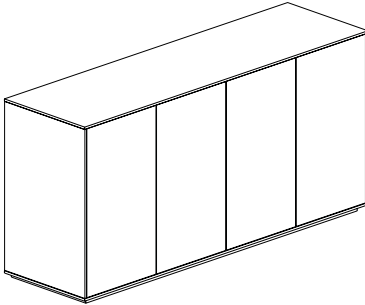

### Options & Upcharges

Pull: Cove / Tab (Silver) / Tab (Black)

D	W	H	MODEL NUMBER	PRICE
20	60	36	<b>ACFS2D206036</b>	3610
20	72	36	<b>ACFS2D207236</b>	3610
20	84	36	<b>ACFS2D208436</b>	3610

---

## Sideboard Credenza

Sideboard Removable Back

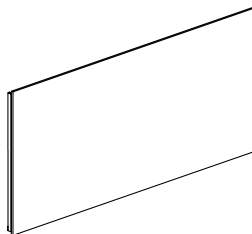

W	H	MODEL NUMBER	PRICE
60	36	<b>ACRCB6036</b>	370
72	36	<b>ACRCB7236</b>	370
84	36	<b>ACRCB8436</b>	370

## In-Surface Dual-Hinge Power Units

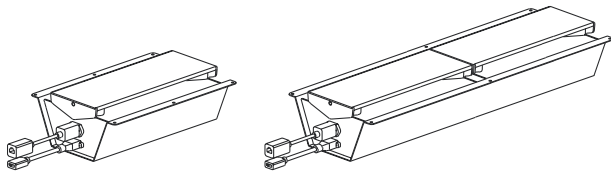

Single Unit

Double Unit: XL

### POWER/DATA

Full Power Plug-In Infeed: 3 pwr, USB A+C, 1 HDMI, 1 CAT6 / 144" cord  
 Full Power Hardwire Infeed: 3 pwr, USB A+C, 1 HDMI, 1 CAT6 / 120" cord  
 Basic Power Plug-In Infeed: Power Strip 4 pwr, 1 HDMI, 1 CAT6 / 120" cord  
 Open: 1 HDMI, 1 CAT6  
 XL Full Power Plug-In Infeed: 6 pwr, 2 USB A+C, 1 HDMI, 1 CAT6 / 144" cord  
 XL Full Power Hardwire Infeed: 6 pwr, 2 USB A+C, 1 HDMI, 1 CAT6 / 120" cord  
 XL Open: 1 HDMI, 1 CAT6

### MODEL NUMBER

### LIST

**WATF** 1540  
**WATC** 1540  
**WATS** 1210  
**WATO** 1050  
**WATXLF** 2590  
**WATXLC** 2590  
**WATXLO** 1540

## Byrne E2X Drop-In Power Units

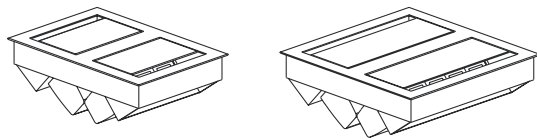

E2X - 3-port per side

E2X - 5-port per side

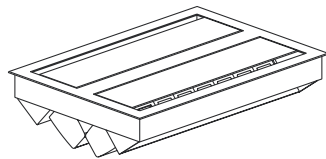

E2X - 8-port per side

### Options & Upcharges

Power Connection Options: Plug-in / Hardwire (+\$200)/ Chicago

### Notes

- All Byrne drop-in power units require surface cutout (+\$55)
- Finishes: Silver/Black, Silver/White, no upcharge. Black/Black (+\$420)

### POWER/DATA

### MODEL NUMBER

### LIST

3-port per side: 2 PWR, 1 USB A+C per side **WPAE2X2P1D** 1460  
 3-port per side: 2 PWR, 1 Open per side **WPAE2X2P10** 1165  
 5-port per side: 3 PWR, 1 USB A+C, 1 Open per side **WPAE2X3P1D10** 1565  
 5-port per side: 3 PWR, 2 Open per side **WPAE2X3P20** 1280  
 8-port per side: 5 PWR, 1 USB A+C, 2 Open per side **WPAE2X5P1D20** 1945  
 8-port: 5 PWR, 3 Open per side **WPAE2X5P30** 1650

## Byrne Ellora Drop-In Power Units

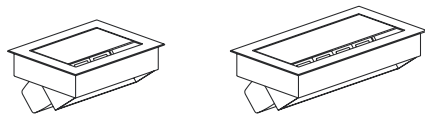

Ellora - 3-port

Ellora - 5-port

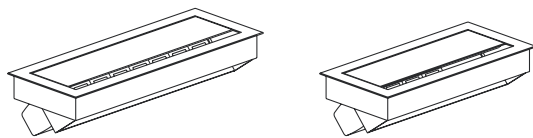

Ellora - 8-port

Ellora Qi

### Options & Upcharges

Power Connection Options: Plug-in / Hardwire (+\$100) / Chicago

### Notes

- All Byrne drop-in power units require surface cutout (+\$55)
- Finishes: Silver/Black, Silver/White, no upcharge. Black/Black (+\$120)
- Units with Qi Charging require \$150 upcharge for Black

### POWER/DATA

### MODEL NUMBER

### LIST

3-port: 2 PWR, 1 Open **WPAE2P10** 685  
 5-port: 3 PWR, 1 USB A+C, 1 Open **WPAE3P1D10** 850  
 5-port: 3 PWR, 2 Open **WPAE3P20** 715  
 8-port: 5 PWR, 1 USB A+C, 2 Open **WPAE5P1D20** 1460  
 8-port: 5 PWR, 3 Open **WPAE5P30** 1315  
 Qi: 3 PWR, 1 USB A+C, 3 Qi coils **WPAEQ3P1D** 1405  
 Qi: 3 PWR, 1 Open, 3 Qi coils **WPAEQ3P10** 1280



## Byrne MhoB Drop-In Power Units

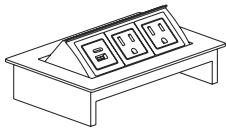

MhoB - 3-port

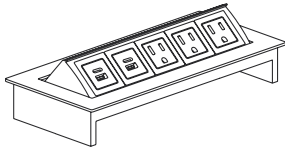

MhoB - 5-port

### Options & Upcharges

**Power Connection Options:** Plug-in / Hardwire (+\$100) / Chicago  
**Finish:** Black/Black (+\$120)

### Notes

- All Byrne drop-in power units require surface cutout (+\$55)

POWER/DATA	MODEL NUMBER	LIST
3-port: 2 PWR, 1 Open	<b>WPAM2P10</b>	495
3-port: 2 PWR, 1 USB A+C	<b>WPAM2P1D</b>	610
5-port: 3 PWR, 2 Open	<b>WPAM3P20</b>	525
5-port: 3 PWR, 2 USB A+C	<b>WPAM3P2D</b>	800

## Byrne Minitap Drop-In Power Unit

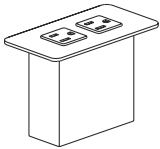

### Options & Upcharges

**Power Connection Options:** Plug-in / Hardwire (+\$100 / Chicago)

### Notes

- All Byrne drop-in power units require surface cutout (+\$55)

POWER/DATA	MODEL NUMBER	LIST
2 PWR	<b>WPASMT2P</b>	475

## Byrne Node Drop-In Power Units



### Options & Upcharges

**Power Connection Options:** Plug-in / Hardwire (+\$100) / Chicago

### Notes

- All Byrne drop-in power units require surface cutout (+\$55)

POWER/DATA	MODEL NUMBER	LIST
2 PWR	<b>WPANWP</b>	345
1 PWR, 1 USB A+C	<b>WPAN1P1D</b>	475